



USER MANUAL FOR HOT TUB

/ CONTROL SYSTEMS / KEYPADS / ACCESSORIES /



WARNING

REDUCE THE RISK OF ELECTROCUTION

- Never place an electric appliance within 5 feet of hot tub.

REDUCE THE RISK OF CHILD DROWNING

- Supervise children at all times.
- Attach hot tub cover after each use.

REDUCE THE RISK OF OVERHEATING

- Check with a doctor before use if pregnant, diabetic, in poor health, or under medical care.
- Exit immediately if uncomfortable, dizzy, or sleepy. Hot tub heat can cause hyperthermia and unconsciousness.
- Hot tub heat in conjunction with alcohol, drugs, or medication can cause unconsciousness.

WHEN PREGNANT, water temperature before entering.

- Soaking in hot water for long periods can harm your fetus. Measure
- Exit immediately if uncomfortable, dizzy, or sleepy. Hot tub heat can cause hyperthermia and unconsciousness.
- Hot tub heat in conjunction with alcohol, drugs, or medication can cause unconsciousness.

TABLE OF CONTENTS

Introduction	4
Safety instructions	5
Safety instructions - Canada	12
Important safety instructions	15
Controls	16
Initial installation	17
Major components of the product	19
User interface	
Easy 4	37
Easy 7	40
Smart Touch	53
4 and 1 single button panel	77
Optional accessories	
Aquasoul Pro	78
My Music...	82
in.clear	83
in.clear (in Smart Touch)	91
UV-C / Ozone	97
in.grid	98
in.touch 2	101
Sand filter system	124
Water treatment basics	125
Maintenance	126
Wiring diagram	
W2000	127
W3000 & W5000	132
W8000	136
Breaker setting	139
Frequently asked questions	141

INTRODUCTION

Congratulations on your new product!

Outside work and family the enjoyment of quality life and calm moments plays an important role in the life of a 21st century man. An evening bath in the hot tub or tub alone or in company can give you the opportunity to lose track of time and your body and soul can relax. From the world of rationality we get into the world of senses where the cossetting atmosphere of the water provides the perfect conditions for relaxation.

Our design engineers utilised the experiences of the ancient Eastern massage culture and the modern findings of Western hydrotherapy to create hot tubs providing the perfect massage experience.

Develop a peaceful space for relaxation with your product in your home and join the group of the few who seek a positive impact on their environment by establishing internal harmony.

Dive into your hot tub and enjoy the gently flowing water!

The user manual is available at <http://www.wellis.com/catalogue>.

Aeware®, Gecko®, and their respective logos are Registered Trademarks of Gecko Alliance Group. in.yt™, in.ye™, in.yj™, in.touch™, in.stream 2™, DJS™, in.k110™, in.k120™, in.k361™, in.k1001™, in.clear™, and their respective logos are Trademarks of Gecko Alliance Group.

All other product or company names that may be mentioned in this publication are tradenames, trademarks or registered trademarks of their respective owners.

IMPORTANT SAFETY INSTRUCTIONS

1. **READ AND FOLLOW ALL INSTRUCTIONS.**
2. **WARNING** – To reduce the risk of injury, do not permit children to use this product unless they are closely supervised at all times.
3. A wire connector is provided on this unit to connect a minimum 8 AWG (8.4 mm²) solid copper conductor between this unit and any metal equipment, metal enclosures of electrical equipment, metal water pipe, or conduit within 5 feet (1.5 m) of the unit.
4. (For cord-connected/convertible units) **DANGER** – Risk of injury.
 - a) Replace damaged cord immediately.
 - b) Do not bury cord.
 - c) Connect to a grounded, grounding type receptacle only.
5. **DANGER** – Risk of Accidental Drowning. Extreme caution must be exercised to prevent unauthorized access by children. To avoid accidents, ensure that children cannot use this hot tub unless they are supervised at all times.
6. **DANGER** – Risk of Injury. The suction fittings in this hot tub are sized to match the specific water flow created by the pump. Should the need arise to replace the suction fittings or the pump, be sure that the flow rates are compatible.
 Never operate hot tub if the suction fittings are broken or missing. Never replace a suction fitting with one rated less than the flow rate marked on the original suction fitting.
7. **DANGER** – Risk of Electric Shock. Install at least 5 feet (1.5 m) from all metal surfaces. As an alternative, a hot tub may be installed within 5 feet of metal surfaces if each metal surface is permanently connected by a minimum 8 AWG (8.4 mm²) solid copper conductor to the wire connector on the terminal box that is provided for this purpose.
8. **DANGER** – Risk of Electric Shock. Do not permit any electric appliance, such as a light, telephone, radio, or television, within 5 feet (1.5 m) of a hot tub.
9. **WARNING** – To reduce the risk of injury:
 - a) The water in a hot tub should never exceed 40°C (104°F). Water temperatures between 38°C (100°F) and 40°C are considered safe for a healthy adult. Lower water temperatures are recommended for young children and when hot tub use exceeds 10 minutes.
 - b) Since excessive water temperatures have a high potential for causing fetal damage during the early months of pregnancy, pregnant or possibly pregnant women should limit hot tub water temperatures to 38°C (100°F).
 - c) Before entering a hot tub, the user should measure the water temperature since the tolerance of water temperature-regulating devices varies.
 - d) The use of alcohol, drugs, or medication before or during hot tub use may lead to unconsciousness with the possibility of drowning.
 - e) Obese persons and persons with a history of heart disease, low or high blood pressure, circulatory system problems, or diabetes should consult a physician before using a hot tub.
 - f) Persons using medication should consult a physician before using a hot tub since some medication may induce drowsiness while other medication may affect heart rate, blood pressure, and circulation.

13. SAVE THESE INSTRUCTIONS.

Audio/video components

- a) "CAUTION – Risk of Electric Shock. Do not leave compartment door open";
- b) "CAUTION – Risk of Electric Shock. Replace components only with identical components"; and
- c) "Do not operate the audio/video controls while inside in the hot tub".
- d) "WARNING – Prevent Electrocutation. Do not connect any auxiliary components (for example cable, additional speakers, headphones, additional audio/video components, etc.) to the system".
- e) These units are not provided with an outdoor antennae; when provided, it should be installed in accordance with Article 810 of the National Electrical Code, ANSI/NFPA 70.
- f) Do not service this product yourself as opening or removing covers may expose you to dangerous voltage or other risk of injury. Refer all servicing to qualified service personnel.
- g) When the power supply connections or power supply cord(s) are damaged; if water is entering the audio/video compartment or any electrical equipment compartment area; if the protective shields or barriers are showing signs of deterioration; or if there are signs of other potential damage to the unit, turn off the unit and refer servicing to a qualified service personnel.
- h) This unit should be subjected to periodic routine maintenance (for example, once every 3 months) to make sure that the unit is operating properly.

FOR YOUR SAFETY PLEASE ALWAYS PERFORM THE FOLLOWING PRECAUTIONS. IF YOU DO NOT FOLLOW THE WARNINGS AND INSTRUCTIONS, ITEMS MAY GET DAMAGED, YOU MAY GET INJURED, OR YOU MAY SUFFER FATAL INJURY. IMPROPER INSTALLATION AND OPERATION INVALIDATES THE WARRANTY.

AVOIDING THE RISK TO CHILDREN

- To reduce the risk of injury, lower water temperatures are recommended for young children. Children are especially sensitive to hot water.
- Extreme caution must be exercised to prevent unauthorized access by children. To avoid accidents, ensure that children cannot use a hot tub unless they are supervised at all times.

DO:

- Make sure you always lock the child resistant locks after using the hot tub for your children's safety.
- Test the water temperature with your hand before allowing children to enter the hot tub to be sure that it's comfortable. Children are especially sensitive to hot water.
- Remind children that wet surfaces can be very slippery. Make sure that children are careful when entering or exiting the hot tub.
- Do not allow children to climb onto the hot tub cover.
- Do not allow children to have unsupervised access to the hot tub.

SAFETY INSTRUCTIONS

AVOIDING THE RISK OF ELECTROCUTION



DANGER - RISK OF ELECTROCUTION

Initial safety warnings

- The hot tub must be powered through a residual current device (rCD) with a current release not exceeding 30mA.
- The devices and parts which contain active parts – except those which are powered from protective extralow voltage not exceeding 12V – must be inaccessible from the hot tub.
- Connect only to a grounded source.
- Do not bury the power cord. A buried power cord may result in death, or serious personal injury due to electrocution if direct burial-type cable is not used, or if improper digging occurs.



WARNING

- To reduce the risk of electrical shock, replace a damaged cord immediately. Failure to do so may result in death or serious personal injury due to electrocution.
- Your hot tub must be connected to a Ground Fault Circuit Interrupter (GFCI) for user and equipment protection. To ensure proper operation of this important safety device, test according to the following instructions per electrical configuration.
- **Cord-Connected 115 volt, 20 amp models:** The GFCI is located at the end of the power cord. Before each use, with the unit operating, push the TEST button. The unit should stop operating and the GFCI power indicator will go out. Wait 30 seconds and then reset the GFCI by pushing the RESET button. The GFCI power indicator will turn on, restoring power to the hot tub. If the interrupter does not perform in this manner, there

may be an electrical malfunction and with it, the possibility of an electric shock. Disconnect the power until the problem has been corrected.

- **2x120 volt, permanently connected or converted models:**
- A ground terminal is provided on the terminal block (TB-1, system ground terminal) located inside the control box. To reduce the risk of electric shock, connect this terminal to the grounding terminal of your electrical service or supply panel with a continuous green, insulated copper wire. The wire must be equivalent in size to the circuit conductors supplying the equipment. In addition, a bonding terminal (pressure wire connector) is provided on the outside of the control box for bonding to local ground points. To reduce the risk of electric shock, this connector should be bonded with a No. 8 AWG (8.4 mm²) solid copper wire to any metal ladders, water pipes, or other metal within 5 feet (1.5 m) of the hot tub to comply with local requirements. The means of disconnection must be readily accessible, but must be installed at least 5 feet (1.5 m) from the hot tub.
- Your hot tub is provided with a suitably rated circuit breaker to open all ungrounded supply conductors.
- Your hot tub uses ground fault circuit interrupters in the electrical subpanel. Before each use of the hot tub and with the unit operating, push the TEST button on each breaker. The switch should click over to the “Trip” position. Wait 30 seconds and reset each GFCI breaker by switching it completely off and then completely on.

The switch should then stay on. If either of the interrupters does not perform in this manner, it is an indication of an electrical malfunction and the possibility of an electric shock. Disconnect the power until the fault has been identified and corrected.

SAFETY INSTRUCTIONS

IMPORTANT: Failure to wait 30 seconds before resetting the GFCI may cause the hot tub's Power Indicator (on the control panel) to blink. If this occurs, repeat the GFCI test procedure.



DANGER - RISK OF ELECTRIC SHOCK

- A wire connector is provided on this unit to connect a minimum 8 AWG (8.4 mm²) solid copper conductor between this unit and any metal equipment, metal enclosures of electrical equipment, metal water pipe, or conduit within 5 feet (1.5 m) of the unit.
- Install at least 5 feet (1.5 m) from all metal surfaces. As an alternative, a hot tub may be installed within 5 feet of metal surfaces if each metal surface is permanently connected by a minimum 8 AWG (8.4 mm²) solid copper conductor to the wire connector on the terminal box that is provided for this purpose.
- Do not permit any electric appliance, such as a light, telephone, radio, or television, within 5 feet (1.5 m) of a hot tub. Failure to maintain a safe distance may result in death, or serious personal injury due to electrocution, if the appliance should fall into the hot tub.
- Install your hot tub in such a way that drainage is away from the electrical compartment and from all electrical components.
- **CAUTION** — Risk of Electric Shock. Do not leave compartment door open
- **CAUTION** — Risk of Electric Shock. Replace components only with identical components
- Do not service this product yourself as opening or removing covers may expose you to dangerous voltage or other risk of injury. Refer all servicing to qualified service personnel.

DO:

- Be sure your hot tub is connected to the power supply correctly - use a licensed electrical contractor.
- Disconnect the hot tub from the power supply before draining the hot tub or servicing the electrical components.
- Test the Ground Fault Circuit Interrupter(s) before each use.
- Do not use the hot tub with the equipment compartment door removed.
- Do not place electrical appliances within 5 feet (1.5m) of the hot tub.
- Do not use an extension cord to connect the hot tub to its power source. The cord may not be properly grounded and the connection is a shock hazard. An extension cord may cause a voltage drop, which will cause overheating of the jet pump motor and motor damage.
- Do not attempt to open the electrical control box. There are no user serviceable parts inside.

RISKS TO AVOID



DANGER - RISK OF INJURY

- To reduce the risk of injury to persons, **DO NOT** remove suction fittings (filter standpipes) located in the filter compartment.
- There is a danger of slipping and falling. Remember that wet surfaces can be very slippery. Take care when entering or exiting the hot tub.
- Never operate hot tub if the suction fittings are broken or missing.
- People with infectious diseases should not use the hot tub.
- Keep any loose articles of clothing, long hair, or hanging jewelry away from rotating jets or other moving components.

SAFETY INSTRUCTIONS

- Water treatment should be carried out with caution. Improperly chemically treated water may cause skin irritation.
- Do not remove any suction sealing.
- Do not operate the hot tub if the suction sealing is broken or missing.
- Keep your clothes and jewellery away from rotating jets and moving parts.
- Effects of overheating: you cannot assess emergency situations, do not feel the temperature, do not feel the need to get out of the hot tub, cannot get out of the hot tub; risk of fetal damage in pregnant women, loss of consciousness, suffocation.
- Do not use the hot tub alone.
- Do not use the hot tub immediately after strenuous sport.

INCREASED SIDE EFFECTS OF MEDICATION

- The use of drugs, alcohol may cause unconsciousness with the possibility of drowning.

HEALTH PROBLEMS AFFECTED BY HOT TUB USE

- Pregnant women should consult a physician before using hot tub.
- Obese persons and persons with a history of heart disease, low or high blood pressure, circulatory system problems, or diabetes should consult a physician before using a hot tub.

AVOIDING THE RISK OF HYPERTHERMIA

Prolonged immersion in hot water can result in HYPERTHERMIA, Hyperthermia occurs when the internal temperature of the body reaches a level several degrees above the normal body temperature of 98.6°F. The symptoms of hyperthermia include an increase in the internal temperature of the body, dizziness, lethargy, drowsiness, and fainting. The effects of

hyperthermia include failure to perceive heat; failure to recognize the need to exit hot tub or hot tub; unawareness of impending hazard; fetal damage in pregnant women; physical inability to exit the hot tub or hot tub; and unconsciousness resulting in the danger of drowning.



WARNING

The use of alcohol, drugs, or medication before or during hot tub use may lead to unconsciousness with the possibility of drowning.

TO REDUCE THE RISK OF INJURY

- The water in a hot tub should never exceed 40°C (104°F). Water temperatures between 38°C (100°F) and 40°C are considered safe for a healthy adult. Lower water temperatures are recommended for young children and when hot tub use exceeds 10 minutes. Extended use can cause hyperthermia.
- Since excessive water temperatures have a high potential for causing fetal damage during the early months of pregnancy, pregnant or possibly pregnant women should limit hot tub water temperatures to 38°C (100°F).
- Pregnant or possibly pregnant women should limit hot tub water temperatures to 100°F (36°C). Failure to do so may result in permanent injury to your baby.
- Do not use hot tub immediately following strenuous exercise.
- Obese persons and persons with a history of heart disease, low or high blood pressure, circulatory system problems, or diabetes should consult a physician before using a hot tub.

SAFETY INSTRUCTIONS

AVOIDING THE RISK OF SKIN BURNS

- Before entering a hot tub, the user should measure the water temperature since the tolerance of water temperature-regulating devices varies.
- To reduce the risk of injury, before entering a hot tub the user should measure the water temperature with an accurate thermometer.
- Test the water with your hand before entering the hot tub to be sure it's comfortable.

PRODUCT SAFETY AND MAINTENANCE

For units intended for use in other than single-family dwellings, a clearly labeled emergency switch must be provided as part of the installation. The switch must be readily accessible to the occupants and must be installed at least 5 feet (1.52 m) away, adjacent to, and within sight of, the unit.

When the hot tub is not in use, cover the hot tub with the cover to prevent ultraviolet radiation causing damage to the product.

Do not remove any suction sealing. Do not operate the hot tub if the suction sealing is broken or missing.

Keep your clothes and jewellery away from rotating jets and moving parts.

Test the residual current device before use.

Disconnect the hot tub from the power supply before servicing its electrical parts. (This operation can only be performed by qualified professionals).

It is strictly prohibited to use the hot tub in a not completely assembled state (e.g. detached side panel)

Chemical treatment of water can only be performed by persons under the age of 18 under parental supervision.

Maintenance can only be performed by trained professionals.

The user should check the electrical wiring every 3 months. It is required to perform a check by a professional every 3 years.

Mains fuses / circuit breakers may be activated because of power outages.

Installation and wiring of the hot tub, replacement of power cord, and any repairs must be performed by qualified profession- als.

It is required to build in an isolating device to the fixed wiring.

PLUG'N'PLAY SAFETY WARNINGS BEYOND THE PREVIOUS WARNINGS, PLEASE ALSO PAY ATTENTION TO THE UNDERMENTIONED ONES.

ATTENTION! *The electrical receptacle must be located at least 2.5 meters from the hot tub so that bathers in a sitting position cannot reach it from the water. The plug can only be connected to a receptacle equipped with 2.5mm 2 diameter cables.*

ATTENTION! RISK OF ELECTRIC SHOCK. *The connector with residual current device must be inspected before every use.*

ATTENTION! *Only place the RCD plug in a receptacle equipped with RCD.*

ATTENTION! *Before you insert the plug into the socket ensure that the current of the socket and the fixed wiring is appropriate for the properties of the hot tub.*

The hot tub must be equipped with an isolation transformer or powered through a residual current device with a release current not exceeding 30mA.

This product is equipped with a ground fault circuit breaker (GFCI) in the connector. GFCI must be tested before each use.

If the power cable is damaged, it must immediately be re- placed by the manufacturer or a service professional in order to minimize danger.

SAFETY INSTRUCTIONS

To minimize the risk of electric shock do not use extension leads to connect the product to the power supply.

Ensure that the receptacle is properly located.

Parts of the equipment cannot be placed above the hot tub during usage.

Parts under electrical power – except those operating with voltage not exceeding 12V - must be inaccessible for persons in the hot tub. The grounded device must be connected to a fixed socket with fixed wiring. Electrical parts – except remote controllers – must be positioned so as not to fall into the hot tub.

The electrical installation must meet the local standard requirements.

To avoid electric shock do not use the hot tub in rain.

Water attracts children. Always place and lock the cover on the hot tub after each usage.

Do not bury cables into the ground! Place the cables so that lawnmowers, trimmers, and similar devices will not reach them.

Do not force push the control panel up nor down and do not place heavy objects on it after installation.

Keep pets away from the hot tub to avoid damage.

Do not use the device if there is the slightest chance of water in the hot tub being frozen.

Only use accessories approved by us. The use of accessories not approved by us may void the warranty.

Choking hazard. Particular attention need to be paid to children during usage. To avoid accidents only allow children to use this hot tub under adult supervision.

To prevent damage to the pump the hot tub can only be operated if it has been filled with water.

If you feel uncomfortably or sleepy, leave the hot tub immediately.

Never add water to the chemicals. Always be cautious when adding chemicals to the hot tub water to avoid inhaling vapors and possible effects of inhaling undiluted chemicals and splatters.

Only place the hot tub on a surface that can support its weight.

Inspect the unit before use. contact the service provider stated in this manual if any of the parts were damaged or missing upon purchase. Ensure that the parts of the unit are those which you intended to buy.

In.clear safety warnings

Beyond the previous warnings, please also pay attention to the undermentioned ones read this manual carefully, always follow its instructions, and retain it. This manual contains important information about the installation, operation, and safety recommendations of the in.clear unit. Safe installation and usage is your responsibility.

The in.clear unit must be connected to a network protected by a ground fault circuit interrupter (GFCI) of the maximal nominal fault current value of 30mA.

Ensure that the entire power supply is turned off before the in.clear unit is installed.

If the power cord is damaged, it must be replaced by the manufacturer, an authorized service provider, or qualified professionals to avoid emergencies.

Always use a proper electric cable for supply of current to the in.clear unit.

When installing the in.clear Automatic Bromine Generator local and international electrical regulations must be complied with.

Clean or replace the filter cartridge at regular intervals, otherwise part of the bromine produced by the in.clear unit will be consumed by oxidation of contamination accumulated in the filter.

DO NOT pour any other chemicals into the hot tub than the recommended sodium bromide.
DO NOT use any ozone or UV disinfectant.

Operating the in.clear unit on lower sodium bromide level shortens the life of the cells. Keeping sodium bromide and bromine levels above the recommended level may lead to corrosion of the hot tub components and cause damage to the hot tub accessories.

Do not open the in.clear unit; it does not contain serviceable parts

Product disposal: the in.clear unit must be disposed of in accordance with local disposal regulations in force.

This device is not intended for use by persons (nor children) with limited physical, sensory, or mental capabilities except if these persons have received appropriate instruction on use of the device from the person responsible for their safety.

The in.clear unit cannot be applied to in-ground sunken hot tubs as it may affect materials used in the construction.

The shut-off device must have fixed wiring in accordance with the cabling regulations.

Showering is compulsory before each hot tub use.

The user is responsible for regular monitoring of the hot tub water to ensure that enough bromine is available to reach the appropriate cleaning level. Intensive hot tub use may require higher bromine intake to always maintain appropriate bromine level.

Always check the expiry date of the test kit, because after this date the test results may be inaccurate.

For proper disinfection hot tubs must periodically be completely drained. The advised time period between full drains given in days is calculated by dividing the capacity of the hot tub in litres by the tenfold of the average daily users.

The in.clear unit is applicable for indoor hot tubs, but NOT for swimming pools.

THIS UNIT SHOULD BE SUBJECTED TO PERIODIC ROUTINE MAINTENANCE (FOR EXAMPLE, ONCE EVERY 3 MONTHS) TO MAKE SURE THAT THE UNIT IS OPERATING PROPERLY.

SAVE THESE INSTRUCTIONS

WARNING: CHILDREN SHOULD NOT USE HOT TUBS OR HOT TUBS WITHOUT ADULT SUPERVISION

AVERTISSEMENT : NE PAS LAISSER LES ENFANTS UTILISER UNE CUVE DE RELAXATION SANS SURVEILLANCE

WARNING: DO NOT USE HOT TUBS OR HOT TUBS UNLESS ALL SUCTION GUARDS ARE INSTALLED TO PREVENT BODY AND HAIR ENTRAPMENT

AVERTISSEMENT : POUR ÉVITER QUE LES CHEVEUX OU UNE PARTIE DU CORPS PUISSENT ÊTRE ASPIRÉS, NE PAS UTILISER UNE CUVE DE RELAXATION SI LES GRILLES DE PRISE D'ASPIRATION NE SONT PAS TOUTES EN PLACE

WARNING: PEOPLE USING MEDICATIONS AND/OR HAVING AN ADVERSE MEDICAL HISTORY SHOULD CONSULT A PHYSICIAN BEFORE USING A HOT TUB OR HOT TUB

AVERTISSEMENT : LES PERSONNES QUI PRENNENT DES MÉDICAMENTS ET (OU) ONT DES PROBLÈMES DE SANTÉ DEVRAIENT CONSULTER UN MÉDECIN AVANT D'UTILISER UNE CUVE DE RELAXATION

WARNING: PEOPLE WITH INFECTIOUS DISEASES SHOULD NOT USE A HOT TUB OR HOT TUB

AVERTISSEMENT : LES PERSONNES ATTEINTES DE MALADIES INFEC-

SAFETY INSTRUCTIONS - CANADA

TIEUSES NE DEVRAIENT PAS UTILISER UNE CUVE DE RELAXATION

WARNING: TO AVOID INJURY, EXERCISE CARE WHEN ENTERING OR EXITING THE HOT TUB OR HOT TUB

AVERTISSEMENT : POUR ÉVITER DES BLESSURES, USER DE PRUDENCE EN ENTRANT DANS UNE CUVE DE RELAXATION ET EN SORTANT

WARNING: DO NOT USE DRUGS OR ALCOHOL BEFORE OR DURING THE USE OF A HOT TUB OR HOT TUB TO AVOID UNCONSCIOUSNESS AND POSSIBLE DROWNING

AVERTISSEMENT : POUR ÉVITER L'ÉVANOUISSEMENT ET LA NOYADE ÉVENTUELLE, NE PRENDRE NI DROGUE NI ALCOOL AVANT D'UTILISER UNE CUVE DE RELAXATION NI QUAND ON S'Y TROUVE

WARNING: PREGNANT OR POSSIBLY PREGNANT WOMEN SHOULD CONSULT A PHYSICIAN BEFORE USING A HOT TUB OR HOT TUB

AVERTISSEMENT : LES FEMMES ENCEINTES, QUE LEUR GROSSESSE SOIT CONFIRMÉE OU NON, DEVRAIENT CONSULTER UN MÉDECIN AVANT D'UTILISER UNE CUVE DE RELAXATION

WARNING: WATER TEMPERATURE IN EXCESS OF 38 °C CAN BE INJURIOUS TO YOUR HEALTH

AVERTISSEMENT : IL PEUT ÊTRE DANGEREUX POUR LA SANTÉ DE SE PLONGER DANS DE L'EAU À PLUS DE 38 °C

WARNING: BEFORE ENTERING THE HOT TUB OR HOT TUB, MEASURE THE WATER TEMPERATURE WITH AN ACCURATE THERMOMETER

AVERTISSEMENT : AVANT D'UTILISER UNE CUVE DE RELAXATION, MESURER LA TEMPÉRATURE

DE L'EAU À L'AIDE D'UN THERMOMÈTRE PRÉCIS

WARNING: DO NOT USE A HOT TUB OR HOT TUB IMMEDIATELY FOLLOWING STRENUOUS EXERCISE

AVERTISSEMENT : NE PAS UTILISER UNE CUVE DE RELAXATION IMMÉDIATEMENT APRÈS UN EXERCICE FATIGANT

WARNING: PROLONGED IMMERSION IN A HOT TUB OR HOT TUB CAN BE INJURIOUS TO YOUR HEALTH

AVERTISSEMENT : L'UTILISATION PROLONGÉE D'UNE CUVE DE RELAXATION PEUT ÊTRE DANGEREUSE POUR LA SANTÉ

WARNING: DO NOT PERMIT ELECTRIC APPLIANCES (SUCH AS A LIGHT, TELEPHONE, RADIO, OR TELEVISION) WITHIN 1.5 M OF THIS SPA OR HOT TUB

AVERTISSEMENT : NE PAS PLACER D'APPAREIL ÉLECTRIQUE (LUMINAIRE, TÉLÉPHONE, RADIO, TÉLÉVISEUR, ETC) À MOINS DE 1.5 M DE CETTE CUVE DE RELAXATION

CAUTION : MAINTAIN WATER CHEMISTRY IN ACCORDANCE WITH MANUFACTURER'S INSTRUCTIONS

ATTENTION: LA TENEUR DE L'EAU EN MATIÈRES DISSOUTES DOIT ÊTRE CONFORME AUX DIRECTIVES DU FABRICANT.

WARNING: THE USE OF ALCOHOL OR DRUGS CAN GREATLY INCREASE THE RISK OF FATAL HYPERTHERMIA IN HOT TUBS AND SPAS

LA CONSOMMATION D'ALCOOL OU DE DROGUE AUGMENTE CONSIDÉRABLEMENT LES RISQUES D'HYPERTHERMIE MORTELLE DANS UNE CUVE DE RELAXATION.

SAFETY INSTRUCTIONS - CANADA

WARNING: RISK OF ACCIDENTAL DROWNING. EXTREME CAUTION MUST BE EXERCISED TO PREVENT UNAUTHORIZED ACCESS. ENSURE THAT CHILDREN CANNOT USE THIS PRODUCT UNLESS THEY ARE SUPERVISED AT ALL TIMES

AVERTISSEMENT : RISQUE DE NOYADE. PRENDRE TOUTES LES PRÉCAUTIONS NÉCESSAIRES POUR INTERDIRE L'ACCÈS AUX PERSONNES NON AUTORISÉES. S'ASSURER QUE LES ENFANTS NE PUISSENT PAS UTILISER CE PRODUIT SANS SURVEILLANCE CONSTANTE

WARNING: RISK OF ACCIDENTAL DROWNING. THE USE OF ALCOHOLIC BEVERAGES OR DRUGS BEFORE OR DURING SPA USE CAN LEAD TO UNCONSCIOUSNESS WITH THE POSSIBILITY OF DROWNING

AVERTISSEMENT : RISQUE DE NOYADE. TOUTE PERSONNE QUI PREND DE LA DROGUE OU DE L'ALCOOL AVANT D'UTILISER UNE CUVE DE RELAXATION OU PENDANT QU'ELLE S'Y TROUVE RISQUE L'ÉVAUOUEMENT ET LA NOYADE

WARNING: RISK OF ACCIDENTAL DROWNING DUE TO HYPERTHER-

MIA. CONSULT THE INSTRUCTIONS PROVIDED WITH THIS UNIT FOR A DESCRIPTION OF THE CAUSES, SYMPTOMS, AND EFFECTS OF HYPERTHERMIA

AVERTISSEMENT : RISQUE DE NOYADE PAR SUITE D'HYPERTHERMIE. LIRE LA NOTICE QUI ACCOMPAGNE

CET APPAREIL; ELLE DÉCRIT LES CAUSES, LES SYMPTÔMES ET LES EFFETS DE L'HYPERTHERMIE

WARNING: RISK OF ELECTRIC SHOCK. DO NOT PERMIT ANY ELECTRIC APPLIANCE (SUCH AS A LIGHT, TELEPHONE, RADIO, OR TELEVISION) WITHIN 1.5 M OF A SPA

AVERTISSEMENT : DANGER D'ÉLECTROCUTION. NE PAS PLACER D'APPAREIL ÉLECTRIQUE (LUMIÈRE, TÉLÉPHONE, RADIO, TÉLÉVISEUR, ETC) À MOINS DE 1.5 M DE CETTE CUVE DE RELAXATION

WARNING: THIS MARKING SHALL BE REMOVED BY THE END USER OF THIS PRODUCT ONLY

AVERTISSEMENT : SEUL L'UTILISATEUR DE CE PRODUIT PEUT ENLEVER CE MARQUAGE.

IMPORTANT SAFETY INSTRUCTIONS

When using this electrical equipment, basic safety precautions should always be followed, including the following:

A) **READ AND FOLLOW ALL INSTRUCTIONS.**

B) A GREEN COLOURED TERMINAL OR A TERMINAL MARKED G, GR, GROUND, GROUNDING, OR THE ⊕ SYMBOL IS LOCATED INSIDE THE SUPPLY TERMINAL BOX OR COMPARTMENT. TO REDUCE THE RISK OF ELECTRIC SHOCK, THIS TERMINAL MUST BE CONNECTED TO THE GROUNDING MEANS PROVIDED IN THE ELECTRIC SUPPLY SERVICE PANEL WITH A CONTINUOUS COPPER WIRE EQUIVALENT IN SIZE TO THE CIRCUIT CONDUCTORS SUPPLYING THIS EQUIPMENT.

C) AT LEAST TWO LUGS MARKED “BONDING LUGS” ARE PROVIDED ON THE EXTERNAL SURFACE OR ON THE INSIDE OF THE SUPPLY TERMINAL BOX OR COMPARTMENT. TO REDUCE THE RISK OF ELECTRIC SHOCK, CONNECT THE LOCAL COMMON BONDING GRID IN THE AREA OF THE HOT TUB OR SPA TO THESE TERMINALS WITH AN INSULATED OR BARE COPPER CONDUCTOR NOT SMALLER THAN NO. 6 AWG.

D) ALL FIELD-INSTALLED METAL COMPONENTS SUCH AS RAILS, LADDERS, DRAINS, OR OTHER SIMILAR HARDWARE WITHIN 3 M OF THE SPA OR HOT TUB SHALL BE BONDED TO THE EQUIPMENT GROUNDING BUS WITH COPPER CONDUCTORS NOT SMALLER THAN NO. 6 AWG.

E) **SAVE THESE INSTRUCTIONS.**

CONTROLS

ENRICHMENT:

With the enrichment tool additional air is introduced to the jets, which strengthens the effect of the massage. Open to the right, close to the left.



WATER FLOW REVERSER

With water reversing you share the jets in each seat. If you turn the jets in each seat. If you turn the water reverser to the right, it will operate the jets on its right seats. if you turn it to the left, it will operate the jets on its left seats. In center position all the jets controlled by water reversing will operate. In this case the efficiency of the massage is reduced (it splits among the seats).

TAP

The tap has an opened and a closed position. When it's open, it can operate the waterfall nozzle, the one-hole fountain, or the neck massage unit. The tap opens to the left, (3, 2/3 rewind) and closes to the right (3, 2/3 rewind).

INITIAL INSTALLATION

SITE PREPARATION

When choosing a site for the hot tub take into account that its maintenance and repair works must be carried out behind the sidewalls, so accessibility and hot tubce to walk around the hot tub must be ensured.

1. INDOOR/BASEMENT INSTALLATION

If you place your hot tub indoors, be aware of some special requirements:

Water may accumulate around the hot tub, so the flooring material must have a proper runoff to avoid accumulation of water. When building a new room for the hot tub, constructing a floor drain is required, or damages may occur due to overflow, overfilling, or technical failure. Our company does not take responsibility for any damage in absence of floor drainage. Humidity will naturally increase in the room where the hot tub is located and the evaporated water condenses. For this reason ensure that the area has proper ventilation. We recommend installing a dehumidifier in the room.

2. OUTDOOR AND PATIO INSTALLATION

A solid horizontal foundation is necessary for installation of the hot tub. We advise using a reinforced concrete foundation at least 10-15cm thick.



Ensure that your deck or foundation will support your hot tub. You must know the maximal load capacity of the foundation. Consult a qualified building contractor or structural engineer.

To find out the weight of your hot tub, its contents and occupants please refer to the hot tub specification chart. This weight must not exceed the structure's rated capacity per square meter, otherwise serious structural damages could result. If you install the hot tub outdoors, we recommend a reinforced horizontal concrete pad at least 10-15cm thick.

Install floor drains around your hot tub to lead water away even in heavy rain.

When constructing the water drain it is advised to form a 10-15cm deep sloping ditch around the hot tub which directs water to the drain. Water from the drain must be directed to the canal or a drainage with enough capacity.

Warning: Do not expose the hot tub to direct sunlight (not even empty) without proper coverage. The insulated hot tub cover preserves the water temperature and provides protection from sunlight and rain. When exposed to sunshine for a longer period it may damage the surface of the hot tub and the hot tub equipment.

Acrylic rapidly absorbs heat from sun rays, thus reaches a very high surface temperature which may damage the hot tub.

In case of sealed design, if the hot tub was placed between glass structures, prevent the sun rays from reaching the hot tub directly through the glass as the temperature may get too high.

3. IN-GROUND / SUNKEN HOT TUB

In case of sinking the hot tub into the ground you must make sufficient space for walking around the hot tub. For completion of maintenance works a minimum of 60cm wide inspection pit must be built around the hot tub.

The inspection pit's bottom must be under the bearing point of the hot tub so that water can flow into the pit in case of water leakage. A floor drain or sump pump should be used at the bottom of the pit to ensure continual water drainage.

In case of sinking the hot tub only the portion below the hot tub's acrylic edge can be sunk. The air of the inspection pit steams up. To prevent unpleasant odors proper ventilation must be provided (e.g. installing ventilators). The costs of pulling the hot tub out of the ground are borne by the user. If the aforementioned conditions are not present, setting up the hot tub may fail.

First filling of the hot tub

Proper filling of the hot tub is an important task both technically and chemically. We advise installation and periodic maintenance by the servicing professionals, which includes inspection and refilling of hot tub water. Hot tubs do not contain water softener and hard water damages the equipment. Improper filling of the hot tub may bring air into the system, which damages the heating wire and engines. Repairs after such failures are not covered by warranty.

Filling process

Remove the hot tub cover. First remove the cover staves, then remove the side covers by unscrewing the bottom screws. During transportation the flare fittings of engines may dislocate. Check these connections before installation. If necessary, tighten the flare fittings.

In hot tubs equipped with air engine the flare fitting must be connected before running the hot tub for the first time.

Before filling the hot tub check that the ratchets are not in a closed state (lever is pulled out and fixed with the safety lock).

Next fill the hot tub with water to the sign indicated on its sidewall.

Filling must be done through the filter housing. Improper filling can damage the engines and heating element.

Insert the filter or filter cartridges when proper water level is reached. Be cautious, because when replacing the filter cartridge air bubbles may remain in the cartridge. To avoid this the filter cartridges must be tilted in the water to remove air from them, and only then fitted to their place.

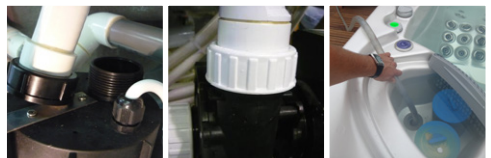

INITIAL INSTALLATION

Electrical preparations:

A clearly labeled emergency switch shall be provided as part of the installation. The switch shall be readily accessible to the occupants and shall be installed at least 5 feet (1.52 m) away, adjacent to, and within sight of, the unit.

Before installation the hot tub, the electrical system has to be prepared, as detailed in the below table.

Applicable cable: Copper 90°C (194°F) THHN/THWN	Ampere rating of the supply circuit overcurrent protective device	AWG rating of the supply conductor
Olympus	50 A	4
Mont Blanc (Elbrus 230)	50A	6
Monte Rosa (Kilimanjaro)	50A	6
Monte Bianco (Discovery)	40A	6
Paris (Elbrus 2018)	40A	6
London (Malaga 2018)	40A	6
Milan (Palermo 2018)	40A	6
Berlin (Marbella 2018)	35A	6
Rome (Manhattan2018)	35A	6
Taurus (Kilimanjaro)	40A	6
Libra	40A	6
Hercules	35 A	6
Leo P&P	15A	6
Leo Scandi pack	30 A	6
Orion P&P	15A	6
Orion Scandi pack	30 A	6
Rio Grande W-Flow	swim space: 55 A hot tub space: 45 A	6 6
Amazon W-Flow	65 A	6
Danube W-Flow	65 A	6

MAJOR COMPONENTS OF THE PRODUCT

OLYMPUS

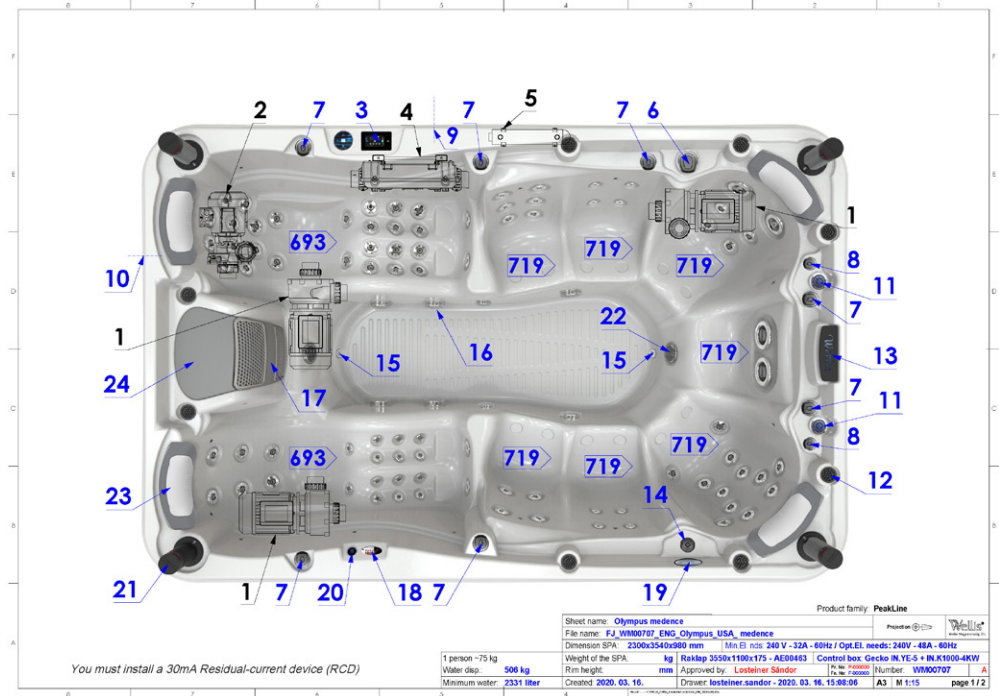

Number	Product code	Product name	PC
1.	ACM0734	Spa Pump 3 HP - One Speed	3
2.	ACM0841	Gecko CMXP circulation pump 190W	1
3.	ACM0768	Control Panel - IN.K1000	1
4.	ACM0776	Control BOX - IN.YE-5	1
	ACM0926	Heater 4KW	1
5.	ACM0888	UV-C Stainless steel house set	1
6.	AKU1894	Water Diverter - Grip Wellis V2	1
7.	AKU1895	Air regulator grip Wellis V2	7
8.	AKU1896	On-off tap grip Wellis V2	2
9.		Electrical connection	1
10.		Drain position	1
11.	AKU0044	Water Pop-Up fountain	2
12.	AKU0056	Cup Holder Light lens	8
13.	AKU1834	Waterfall 276x51x48	1
14.	AM00744	Pump type aromatherapy house	1
15.	AJ00169	Jet - 20 5B - Osone 90°	2
16.	AKU0064	Suction - 73 S / 60.3 S - Thick	6
17.	AKU0060	Filter House - Skimmer Cover I light grey	1
18.	ACM0765	Control Panel - Pulsar / sequencer	1
19.	ACM0762	Control Panel - AUX Four Button	1
20.	ACM0763	Control Panel - AUX One Button	1
21.	ACM0521	Speaker - Round Pop-Up	4
	ACM0849	Subwoofer 288 W	1
	ACM0695	Speaker Cable - 2 x 0.75 RED-BLACK	25
	ACM0769	Amplifier - InStream 2	1
22.	ACM0803	Underwater Light - RGB (7 leds)	2
23.	AF00060	Pillow 420x160x75 (ROB) Wellis two colours	4
24.	AKU0059	Filter House - Skimmer Cover II light grey	1
25.	AKU0047	Filter House - 60.3 S x 60.3 S - Skimmer	1
26.	AKU0116	Spa Filter - 235 x 127 - Wellis Antimicrobial blue (no thread)	1

Product code	Jets	PC
AJ00217	Jet 3" - transparent 1 Hole rotational transparent V3 Wellis	28
AJ00216	Jet 3" - transparent 1 Hole transparent V3 Wellis	34
AJ00214	Jet 2" - transparent 1 Hole transparent V3 Wellis	22
AJ00218	Jet 5" - transparent 1 Hole transparent V3 Wellis	2
AJ00186	Jet swimspa-oval	2
AJ002305ET	5" jet body V3 transparent set	2
AJ002285ET	3" jet body V3 transparent set	62
AJ002265ET	2" jet body V3 transparent set	24
AJ00184	Jet Swim chrome plated	2

You must install a 30mA Residual-current device (RCD)

MAJOR COMPONENTS OF THE PRODUCT

MONT BLANC (ELBRUS 230)

Térel	Cikkszám	ÍRS megnevezés	EN	Db
1	ACM0853	Control box, In-JF-5		1
2	ACM0912	Control Panel - INK1000 V2		1
3	ACM0902	Circulation Pump - CFSOM 250 V 45Hz		1
4	ACM0734	Spa Pump 3 HP - One Speed 60 Hz		3
5	ACM0744	Atomotherapy House		1
6	ACM0938	UV-Ozone Spa Sanitizer - Aquanova		1
7	ACM0904	IN-STREAM2 with quick connector		1
8	ACM0849	Sukker 288W		1
9	ACM0531	Underwater light - house RD		1
10	ASB0409	Suction 2' with nut		3
11	AJ00169	Jet - 20/38 - Ozone 90°		1
12	AKU1893	Jet - 20/38 - Ozone 90° - transparent V2		1
13	AKU1892	Air Regulator - house led lighted V2		6
14	AKU0056	Cup holder - transparent lighted V2		6
15	AKU1891	Water Diverter 60 - LED lighted V2		2
16	AKU1437	waterfall LED lighted		1
17	AKU2218	LED housing with seal		16
18	AJ00214	Jet 2' - transparent 1 Hole transparent V3 Wells		38
19	AJ00216	Jet 3' - transparent 1 Hole transparent V3 Wells		12
20	AJ00217	Jet 4' - transparent 1 Hole Rotation transparent V3 Wells		24
21	AJ00219	Jet 5' - transparent 1 Hole total rotation transparent V3 Wells		2
22	AKU1895	Air regulator grip wells V2		6
23	AKU1896	On-driftap grip wells V2		1
24	AKU1894	Water Diverter - Grip Wells V2		2
25	AJ00218	Jet 5' - transparent 1 Hole transparent V3 Wells		2
26	AKU1835	Slimmer house light grey		1
27	AKU1833	Filter House - Slimmer		1
28	AKU0136	Cover grey with Wells logo		3
29	AF00060	Pillow 420x160x75 (RCB)		4
30	AJ00247	Jet water circulation self-circulation		3
31	AJ00245	Jet water circulation self-circulation leveling nut		3
32	AJ00246	Sealing for jet water circulation		3
33	AKU00684	Water Drain - 90 RB V2		1

You must install a 30mA Residual-current device (RCD)!

Sheet name: MONT BLANC (Elbrus 230)	Product family: USA Line
File name: FJ_WIM00570_ENG_MONT_BLANC_(Elbrus 230)_mediana_USA	Register
Dimension SPA: 2300x2300x900 mm E nos: 240 V - 60Hz	
Weight of the SPA: 370 kg Fuel ELB230 020026x14 - Absent	Control box: GECKO YE5+K1000
Rim height: 137 mm Approved by: Lusteiner Sándor	File name: WIM00570
Created: 2020. 03. 24.	Drawn: lusteiner.sandor - 2020. 03. 24. - 16:00:34cs M.115
Flow rate filter/dm: 2130	Page 1 / 1
1 person - 75 kg	
Water disp.: 603 kg	
Minimum water: 1180 liter	

MAJOR COMPONENTS OF THE PRODUCT

MONTE BIANCO (DISCOVERY)

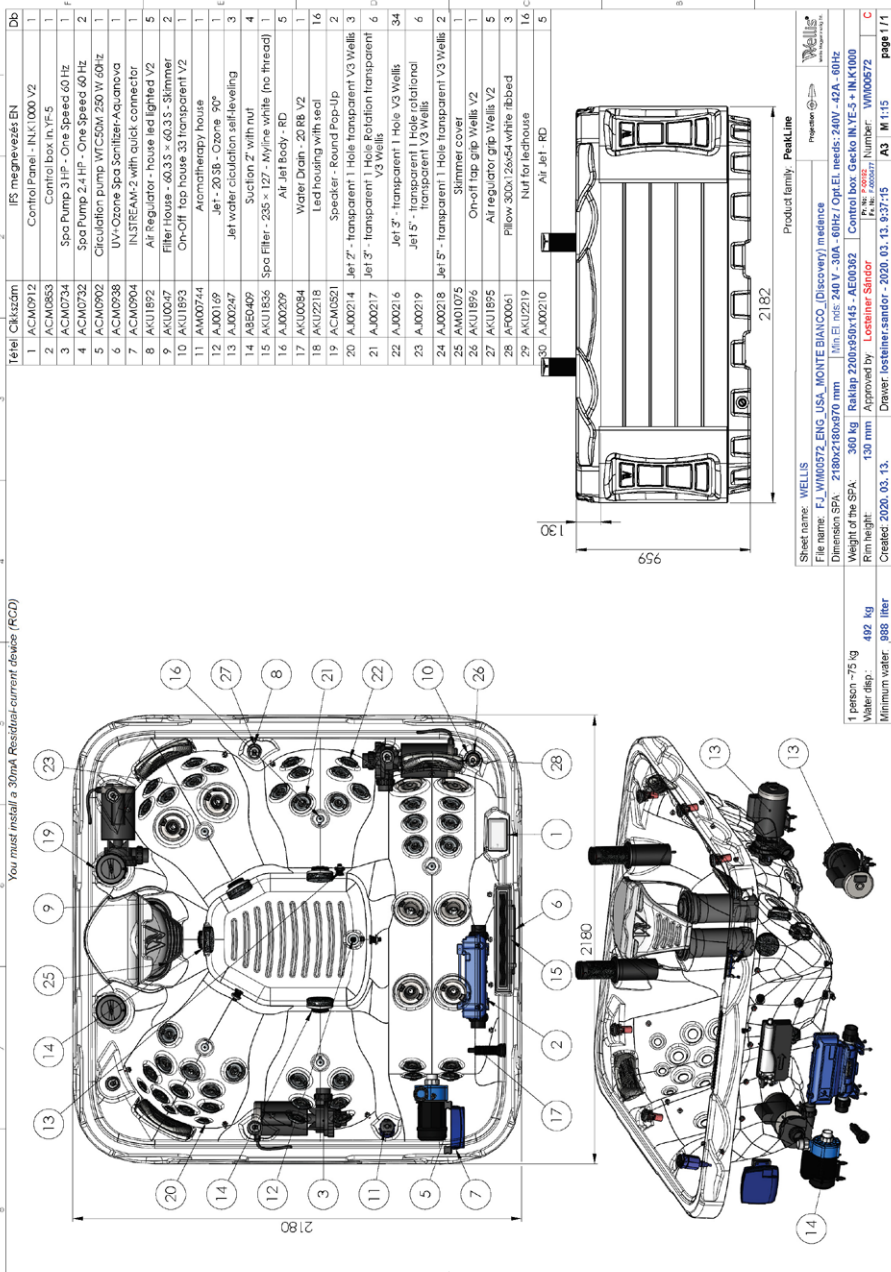

MAJOR COMPONENTS OF THE PRODUCT

MONTE ROSA (KILIMANJARO)

Teljes Cikkszám	IS megnevezés/EN	Db
1	ACM0734 Spa Pump 3 HP - One Speed 60 Hz	3
2	ACM0932 Circulation pumps W/CSM 250 W 60Hz	1
3	ACM0853 Control box in Y5	1
4	ACM0912 Control Panel - INK1000 V2	1
5	ACM0938 UV-Ozone Spa sanitizer-KaučunoVa	1
6	ACM0369 Speaker- OvalPopUp	2
7	AKU0218 Led housing with seal	13
8	ACM0904 INSTREAM-2 with quick connector	1
9	ACM0849 Subwoofer 285W	1
10	ACM0803 Underwater Light - RGB (7 leds)	1
11	ACM0531 Underwater Light - House RD	1
12	AKU1893 On/Off top house 33 transparent V2	1
13	AKU0044 Water Pop-Up fountain	2
14	AKU1892 Air Regulator - house led lighted V2	5
15	AM00744 Atomotherapy house	1
16	AKU1891 Water Diverter 60 - LED lighted V2	1
17	AKU0056 Cup Holder Light lens light tube/transparent	3
18	A-00067 Jet water circulation self-leaving	3
19	A0E0469 Suction 2" with nut	4
20	AJ00169 Jet - 20.38 - Ozone 50"	1
21	AKU0064 Water Drain - 20 RB V2	1
22	A-000214 Jet 2" - transparent 1 Hole transparent V3 Wells	27
23	A-000216 Jet 3" - transparent 1 Hole V3 Wells	6
24	A-000217 Jet 3" - transparent 1 Hole Rotation transparent V3 Wells	20
25	A-000218 Jet 5" - transparent 1 Hole transparent V3 Wells	7
26	A-000219 Jet 5" - transparent 1 Hole (optional) transparent V3 Wells	4
27	AKU1894 Water Diverter - Cup Wells V2	1
28	AKU1895 Air regulator cup Wells V2	5
29	AKU1896 On-off top grip Wells V2	1
30	AKU1833 Filter House - transparent grey with Wells logo	1
31	AKU1835 Summer house light grey	1
32	AFO0060 Pillow 420x16x25 RC081 Wells bwe colour	3
33	AJ00136 Spa Filter- 175 x 132- Wells Antimicrobiable (free thread)	3

You must install a 30mA Residual-current device (RCD)

Sheet name:	WELLS	Product family:	USA Line
File name:	FJ_W000571_MONTE_ROSA_(Kilimanjaro)_medicina_USA	Registration:	
Dimension SPL:	2300x2300x640 mm	Min. El. size:	240 V - 30A - 60Hz / Opt.El. needs: 240V - 48A - 60Hz
Weight of the SPA:	387 kg	Installation:	Control box: GECKO YE3 + K1000
Rim height:	100 mm	Approved by:	Lucastiner Sándor
Created:	2020. 03. 13.	Drawn:	lucastiner.sandor - 2020. 03. 13. - 1122396cs
Minimum water:	1500 liter	Number:	W000571
		Page:	1 / 17

MAJOR COMPONENTS OF THE PRODUCT

PARIS (ELBRUS 2018)

Tétel	Cskaszám	IS megnevezés EN	Dob
1	ACM0734	Isap Pump 3 HP - One Speed 60 Hz	2
2	ACM0902	Circulation pump WTC300M 250 W 60Hz	1
3	ACM0912	Control Panel - INK1000 V2	1
4	ACM0874	Speaker 3" (2 way)	2
5	ACM0875	Grille for speaker 3" (2 way)	2
6	ACM0893	JUV-C stainless steel house jet 60Hz	1
7	AM00744	Aeromotherapy house	1
8	ABED059	Suction 2" with nut	4
9	AUJ2101	Fountain lamina V2	2
10	AUJ1914	Waterjet 27x651x48	2
11	A-00247	Jet washer circulation jet/shielding	1
12	A-00169	Jet 2" - 20.38 - Ozone V0	1
13	AJ00214	Jet 2" - transparent 1 Hole transparent V3 Walls	10
14	AJ00216	Jet 3" - transparent 1 Hole V3 Walls	13
15	AJ00217	Jet 3" - transparent 1 Hole rotation transparent V3 Walls	10
16	AJ00218	Jet 3" - transparent 1 Hole transparent V3 Walls	6
17	AJ00219	Jet 3" - transparent 1 Hole rotational	1
18	AJ00041	Pillow 320x126x54 white ribbed	4
19	AUJ0064	Water Drain - 20 PR V2	1
20	AUJ1830	Filter house for floating 50 jet filters	1
21	AUJ1832	Filter House - Slimmer Cover round	1
22	AUJ1842	Slimmer House with Walls top	1
23	AJ01892	Air Regulator - hours led lightless V2	7
24	AJ01895	Air regulator grip Walls V2	7
25	AJ01893	On-Off tap house 33 transparent V2	2
26	AJ01896	On-off tap grip Walls V2	2
27	AJED079	Spring Clamp	2
28	ACM09236	Heating 1-4 kW Gecko INLY control	1
29	ACM09533	Control box IN-Y13 60Hz V3	1

You must install a 30mA Residual-current device (RCD)

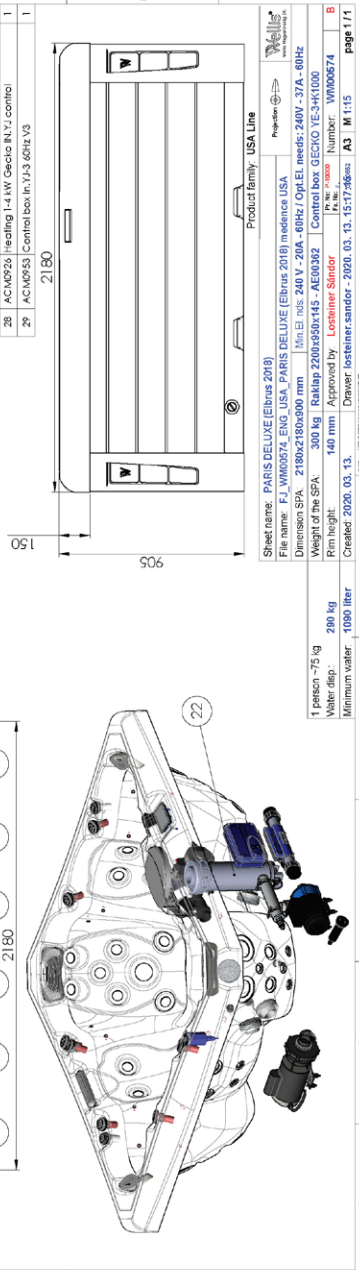

Product family: USA Line

Sheet name: PARIS DELUXE (Elbrus 2018)

File name: E:\VIBROSTL\ENG\USA_Paris DELUXE (Elbrus 2018) rml.dwg

Dimensions SPA: 2180x2180x900 mm (In. Lx Wx H: 241 V - 204 - 60Hz / Opt file: 200V - 37A - 60Hz)

Weight of the SPA: 300 kg (Ballast 2200x950x145 - AEJ00362)

Control box: GECKO VE-34K1000

Pin height: 148 mm

Approved by: **Lespiner Sándor**

Created: 2020.03.13. 15:17:38

Drawn: fostaner.sandor - 2020.03.13. 15:17:38

Page 1/1

- 1 person - 75 kg
- Water flap - 290 kg
- Minimum water: 1090 liter

MAJOR COMPONENTS OF THE PRODUCT

LONDON (MALAGA 2018)

Fénel	Clık-kodum	İRS meğnavezi FN	Dk
1	AKM0734	Spot Pump 3 HP - One Speed 40 Hz	2
2	AKM0902	Circulation pump VTC50M 250 W 60Hz	1
3	AKM0854	Control box In.FI-3	1
4	AKM0912	Subwoofer 288W	1
5	AKM0849	UV-C Stainless steel house set 60Hz	1
6	AKM0874	Speaker 3" (2 way)	2
7	AKM0875	Gille for speaker 3" (2 way)	2
8	AKM1916	Waterfall 27x63x48	1
9	AKM1916	Fountain lamina V2	3
10	AKM0744	Aromatherapy house	1
11	AKM0744	Suction 2" with nut	3
12	AREC409	Jet water circulation self-veiling	2
13	AJ00247	Jet - 20.35 - Ozone 90"	1
14	AJ00167	Water Drain - 20 RB V2	1
15	AKM0084	Filler house for floating 5q filters	1
16	AKM1830	Filter House - Skimmer Coverround	1
17	AKM1832	Skimmer house with Wells logo	1
18	AKM1842	Water Diverter 60 - LED lighted V2	1
19	AKM1891	Air Regulator - house led lighted V2	2
20	AKM1892	On-Off tap house 33 transparent V2	2
21	AKM1863	Water Diverter - 60p Wells V2	6
22	AKM1884	Air regulator 60p Wells V2	2
23	AKM1885	On-off tap 60p Wells V2	2
24	AKM1886	Jet 2" - transparent 1 Hole transparent V3 Wells	5
25	AJ00214	Jet 3" - transparent 1 Hole V3 Wells	14
26	AJ00216	Jet 3" - transparent 1 Hole V3 Wells	14
27	AJ00217	Jet 3" - transparent 1 Hole V3 Wells	8
28	AJ00218	Jet 5" - transparent 1 Hole transparent V3 Wells	9
29	AJ00219	Jet 5" - transparent 1 Hole not for sale	4
30	AF00061	Pillow 300x126x54 white ribbed	3

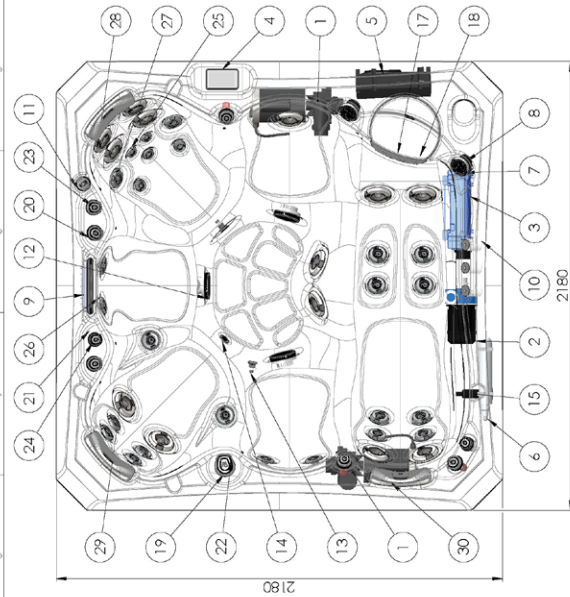

You must install a 30mA Residual-current device (RCD)

Product family: USA Line

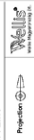

Sheet name: LONDON Deluxe (Malaga 2018)
 File name: EI_W000571.ENG_USA_LONDON Deluxe (Malaga 2018).indd
 Dimensions: 2180x2180x900 mm
 Weight of the SPA: 330 kg
 Pin height: 140 mm
 Created: 2020.03.13. 15:24:06:03

1 person - 75 kg
 Water flap - 383 kg
 Minimum water - 1136 liter

Approved by: **Lesplaine Sándor**
 Number: W000573

Page 11 of 20

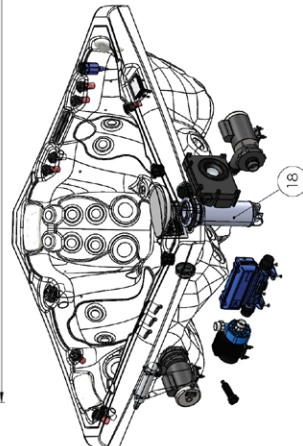

MAJOR COMPONENTS OF THE PRODUCT

MILAN (PALERMO 2018)

1	2	3	4	5	6	7	8	9	10	11	12	13	14	15	16	17	18	19	20	21	22	23	24	25	26	27	28	29	30	31	32	Db	
1	2	3	4	5	6	7	8	9	10	11	12	13	14	15	16	17	18	19	20	21	22	23	24	25	26	27	28	29	30	31	32		
1	2	3	4	5	6	7	8	9	10	11	12	13	14	15	16	17	18	19	20	21	22	23	24	25	26	27	28	29	30	31	32		
AKM0734	AKM0902	AKM0893	AKM0904	AKM0912	AKM0849	AKM0874	AKM0875	AKU1830	AKU1832	AKU1842	AKU1891	AKU1892	AKU1893	AKU1894	AKU1895	AKU1896	AKU1916	AKM0044	AKU2101	AKS0469	AKU1839	AKM0069	AKM0047	AKU0084	AFM0061	AKU1833	AKM0016	AKM0017	AKM0018	AKM0019	AKM0926	AKM0933	IS megráveztésEN
Spa Pump 3 HP - One Speed 60 Hz	Circulation pumps WTC50M 250 W 60Hz	UV-C Straps label house set 60Hz	UV-C STRAPS label house set 60Hz	Control Panel with quick connector	Stow cooler 280W	Speaker 3" (2 way)	Grille for speaker 3" (2 way)	Filter house for flooding 50 sqd filters	Filter House - Skimmer. Cover round	Skimmer house with Wells logo	Water Diverter 60 - LED lighted V2	Air Regulator - house led lighted V2	On-Off tap house 33 transparent V2	Water Diverter - Grip Wells V2	Air regulator grip Wells V2	On-off tap grip Wells V2	Waterfall 27x65x148	Aromatherapy house	Fountain lamping V2	Suction 2" with INL	Jet - 20.38 - Ozone ROP	Jet water circulation self-levelling	Water Drain - 20 RB V2	Pillow 300x126x654 white ribbed	Spa filter 32" (3x white sq. sq. no thread)	Jet 3" - transparent 1 Hole V3 Wells	Jet 3" - transparent 1 Hole V3 Wells	Jet 3" - transparent 1 Hole V3 Wells	Jet 5" - transparent 1 Hole transparent V3 Wells	Jet 5" - transparent 1 Hole totalonal transparent V3 Wells	Heating 1-4 kW Gecko IN.Y.7 control	Control box IN.Y.3 60Hz V3	

You must install a 30m⁴ Residual-current device (RCD)

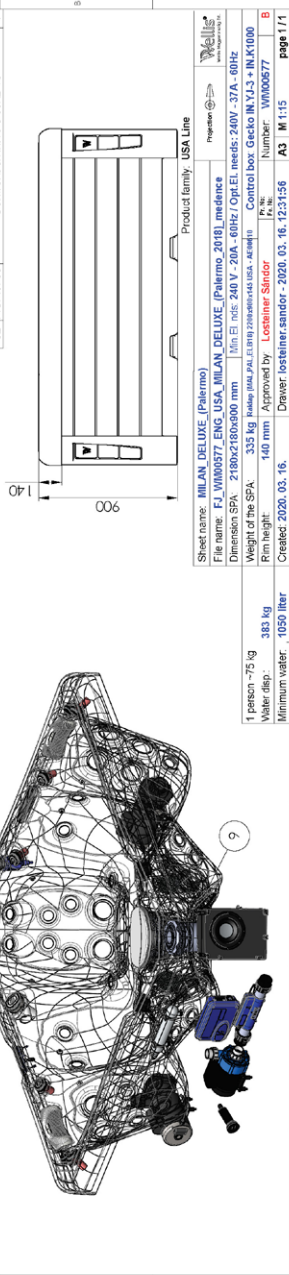

Sheet name: MILAN DELUXE (Palermo)
 File name: F:\W000577.ENG_USA_MILAN_DELUXE (Palermo 2018).immediate
 Dimension SPA: 2180x2180x900 mm | Min. El. (HS): 240 V - 20A - 60Hz / Opt.El. needs: 240V - 37A - 60Hz
 Weight of the SPA: 335 kg | www.palermo.italia.com | www.lesstainer.com | Control box: Gecko IN.Y.3 + IN.K1000
 Rim height: 140 mm | Approved by: **Lesstainer Sándor** | P.N.: Number: W0000577
 Created: 2020.03.16. | Drawer: **lestainer.sandor** - 2020.03.16. - 1233156 | A3 | M.115 | page 1/1

MAJOR COMPONENTS OF THE PRODUCT

BERLIN (MARBELLA 2018)

Level	Cikkszám	ÍRS megnevezés EN	Db
1	ACM0912	Control Panel - INK1000 V2	1
2	ACM0953	Control Box IN V3 60Hz V3	1
3	ACM0734	Spa Pump 3HP - One Speed 60Hz	1
4	ACM0902	Circulation pump WTC50M 250 W 60Hz	1
5	ACM0926	Heating 1-4 kW Gecko (N.Y.) control	1
6	ACM0893	UV-C Stainless steel house set 60Hz	1
7	ACM0904	IRSTRAN-2 with quick connector	1
8	ACM0875	Grills for spraker 3" (2 way)	2
9	ACM0874	Speaker 3" (2 way)	2
10	ACM0849	Subwoofer 288W	1
11	AF00061	Pillow 300x126x54 white ribbed	4
12	A-A0218	Jet 15" - transparent 1 hole transparent V3 Wells	2
13	AKU1916	Waterfall 276x51x48	1
14	AKU1876	On-off tap grip Wells V2	2
15	AKU1893	On-Off tap house 33 transparent V2	2
16	A-A0214	Jet 2" - transparent 1 hole transparent V3	8
17	ASB2429	Suction 2" with nut	2
18	AKU1891	Water Diverter 60 - LED lighted V2	1
19	AKU1894	Water Diverter - Grip Wells V2	1
20	AJ02247	Jet water circulation self-heating	3
21	AJ02216	Jet 3" - transparent 1 Hole V3 Wells	10
22	AKU2101	Fountain fountain V2	3
23	A-A0219	Jet - 20 38 - Ozone 50"	1
24	A-A0217	Jet 3" - transparent 1 hole rotation transparent V3	10
25	AKU1892	Air Regulator - house led lighted V2	4
26	AKU1842	Stammer house with Wells logo	1
27	AKU1832	Filter House - Slimmer Cover round	1
28	AM00744	Aromatherapy house	1
29	AKU1895	Air regulator grip Wells V2	4
30	AKU1830	Filter house for floating 50-stal filters	1

You must install a 30mA Residual-current device (RCD)

Product family: USA Line	
Sheet name: BERLIN DELUXE (Marbella 2018)	Product family: USA Line
File name: E:\W000575-ENG_USA_BERLIN DELUXE (Marbella 2018) part.dwg	Project:
Dimensions SPA: 1900x1800x850 mm	Min. EI size: 240 V - 14A - 60Hz / Ogr EI: max. 200V - 20A - 60Hz
Weight of the SPA: 235 kg	Ratio (mm): 120:80:145:150:150:150:150:150
Pin height: 140 mm	Approved by: Leszli Sándor
Created: 2020.03.16	Drawn: fcs-tanar.sandor - 2020.03.16. 13:22:36
1 person - 75 kg	Number: W000575
Water flap - 300 kg	Min. EI 115
Minimum water: 782 liter	page 1 / 1

MAJOR COMPONENTS OF THE PRODUCT

TAURUS (KILIMANJARO)

Detail	Clk.szám	IS megnevezés EN	Db
1	ACM0734	Spa Pump, 3 HP - One Speed 60 Hz	1
2	ACM0735	Spa Pump, 3 HP - Two Speed 60 Hz	1
3	ACM0854	Control box in VE-3	1
4	AJU0215	LED housing with led	13
5	ACM0907	Ozone - Generator 0,16A	1
6	ACM0874	Speaker 3" (2 way)	2
7	ACM0875	Callie for speaker 3" (2 way)	2
8	AJU0044	Water Pop-Up fountain	2
9	AJU1892	Air Regulator - house led lighted V2	5
10	AJU1891	Water Diverter 40 - LED lighted V2	1
11	AJU0056	Water Diverter - house led lighted V2	2
12	AEE0409	Suction 2" with nuf	4
13	A.J00169	Jet - 20.3S - Ozone 90P	1
14	AJU0084	Water Drain - 20 RB V2	1
15	A.0001.4	Jet 2" - transparent 1 hole transparent V3 Wells	23
16	A.0001.6	Jet 3" - transparent 1 hole V3 Wells	23
17	A.0001.8	Jet 5" - transparent 1 hole transparent V3 Wells	6
18	AJU1893	On-Off tap house, 3/3 transparent V2	1
19	AJU1894	Water Diverter - Grip Wells V2	1
20	AJU1895	Air regulator grip Wells V2	5
21	AJU1896	On-off tap grip Wells V2	1
22	AJK0040	Pillow 420x140x75 (RCH) Wells two colour	3
23	AJU1833	Filter House - Summer Cover grey with Wells logo	1
24	AJU1835	Shimmer mouse light grey	1
25	AJU0136	Spa Filter - 175 x 152 - 110g Antimicrobial blue (line Thread)	3

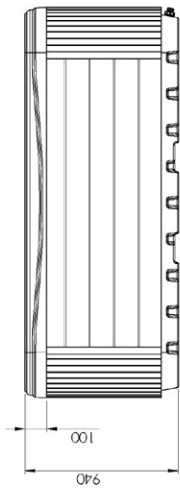
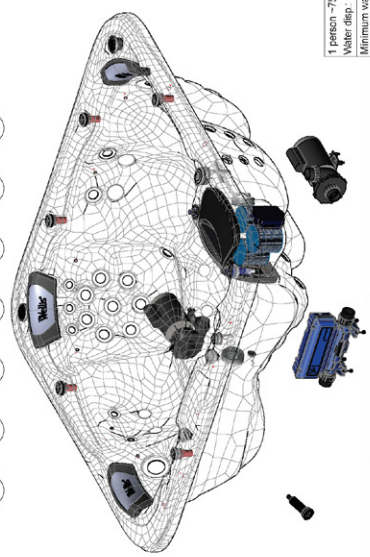

You must install a 30mA Residual-current device (RCD)

Product family: **USA Line**

Sheel társas: **WELLS**

Filialcsoport: **EJ, VM00717, ENG, Taurus (Kilimanjaro), medence, USA**

Dimensions: **2300x2300x640 mm** (W, L, H) Size: **240 V - 10A - 60Hz / Opt.El. needs: 200V - 37A - 60Hz**

Weight of the SPA: **397 kg** (W, L, H) (RCH) 320x340x441 USA - 248斤 / Control box: **Größe in VE-3 - IN 1500 (4KW)**

Pin height: **100 mm** Approved by: **Lochner Sándor** P-n: **0200** Number: **VM00717**

Created: **2020.03.13.** Drawn: **foctester.sandor** - 2020.03.13. 10:55:13 **A3** M 1:17 **page 1 of 1**

1 person - 75 kg
Water fill: **184 kg**
Minimum water: **1500 liter**

MAJOR COMPONENTS OF THE PRODUCT

LIBRA (ELBRUS 230)

Tétel	Cikkszám	ÍR megnevezés EN	DB
1	AKM0734	Spa Pump 3HP - One Speed 60 Hz	1
2	AKM0735	Spa Pump 3HP - Two Speed 60 Hz	1
3	ACM0926	Heating 1-4kW Gecko IN, VJ control	1
4	ACM0947	Ozone - Generator UL USA	1
5	ACM0953	Control box IN, VJ, 60Hz V3	1
6	ACM0874	Speaker 3" (2 way)	2
7	ACM0875	Grille for speaker 3" (2 way)	2
8	AKU10055	Cup holder, light box, light bulb, transparent	6
9	AKU10084	Water Drain - 20 RB V2	1
10	AKU1437	Waterfall LED lighted stainless steel	1
11	AKU1833	Filler House - Skimmer Cover grey with Wells logo	1
12	AKU1835	Skimmer house light grey	1
13	AKU1840	Filler holder - 48 mm	3
14	AKU1891	Water Diverter 60 - LED lighted V2	2
15	AKU1892	Air Regulator - house led lighted V2	5
16	AKU1893	On-Off Tap House 33 transparent V2	1
17	AKU1894	Water Diverter - Grip Wells V2	2
18	AKU1895	Air regulator grip Wells V2	5
19	AKU1896	On-off tap grip Wells V2	1
20	AKU2218	LED housing with seal	16
21	AKU2219	Nut for ledhouse	16
22	AH00045	pillow holder	8
23	AH00040	Pillow 40x61,50x75 (RCB) Wells	4
24	AJ00169	Jet - 20 S3 - Closure 90°	1
25	AJ00216	Jet 3" - transparent 1 Hole V3 Wells	22
26	AJ00214	Jet 2" - transparent 1 Hole transparent V3 Wells	40
27	A8E0409	Suction 2" with nut	3

You must install a 30mA Residual-current device (RCD)

Product family: USA Line

Sheet name: WELLS
 File name: FJ_W100740_ENG_USA_Libra_medicine
 Dimension SPA: 2300x2300x900 mm | Min. El. rise: 240 V - 20A - 60Hz / Opt.El. needs: 240V - 37A - 60Hz
 Weight of the SPA: 370 kg
 Control box: GECKO VJ,3 + K000-4 W7
 Rim height: 137 mm
 Approved by: **Losteinier Sándor**
 Created: 2020. 03. 13. | Drawn: losteinier.sandor - 2020. 03. 13. - 10:58:06:es: A3 | M:1:50
 1 person - 75 kg
 Water disp.: 525 kg
 Minimum water: 1180 liter

1 person - 75 kg
 Water disp.: 525 kg
 Minimum water: 1180 liter

MAJOR COMPONENTS OF THE PRODUCT

HERCULES

Idetel / Cikkszám	RS megnevezés EN	Db
1	ACM0752 Spa Pump 2.4 HP - One speed 60 Hz	1
2	ACM0733 Spa Pump 2 / 0.9 HP - Two Speed 60 Hz	1
3	ACM0953 Control box in V3 60Hz V3	1
4	ACM0760 Control Panel IN K300 - Two Pump	1
5	ACM0926 Heating 1-4 kW Gecko IN V1 control	1
6	ACM0947 Ozone - Generator ILL USA	1
7	AJU0218 Jet housing with seal	16
8	ACM0974 Speaker 3" (2 way)	2
9	ACM0975 Gills for speaker 3" (2 way)	2
10	AJU0169 Jet - 20 38 - Ozone 50°	1
11	AJU0084 Water Pop-Up fountain	2
12	AJU0084 Water Drain - 20 RB V2	1
13	AJU1830 Filter house for floating 50 cdf filters	1
14	AJU1891 Water Diverter 60 - LED lighted V2	1
15	AJU1892 Air Regulator - house led lighted V2	6
16	AJU1893 On-Off top house 33 transparent V2	1
17	AJU1894 Water Diverter - Grip Wells V2	1
18	AJU1895 Air regulator grip Wells V2	6
19	AJU1895 On-off top grip Wells V2	1
20	AJEC009 Suction 2 with nut	2
21	AJF0042 Pillow - 318 x 113 x 60 - Pol. V2 light grey	3
22	AJU0214 Jet 2" - transparent I Hole transparent V3	25
23	AJU0215 Jet 3" - transparent I Hole V3 Wells	12
24	AJU0217 Jet 4" - transparent I Hole Rotation	8

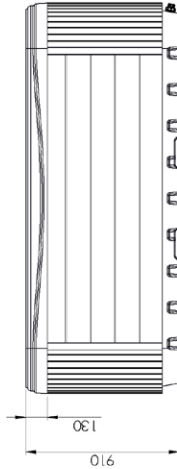

You must install a 30mA Residual-current device (RCD)

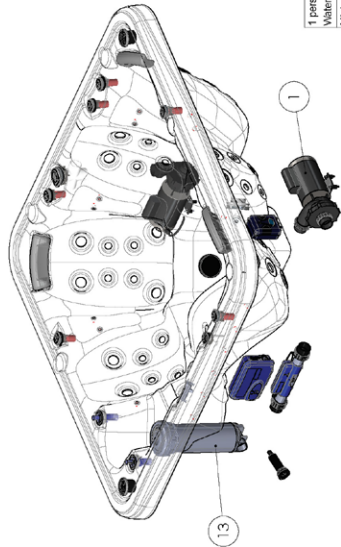

Sheet name: WELLS	Product family: USA Line
File name: E:\W000713_ENG_Hercules (45 L) USA.mxd	Project:
Dimensions: 2150x2150x910 mm	Material: 240 V, 240 V, 60Hz / Opt EI, made: 200V, 32A, 60Hz
Weight of the SPA: 278 kg	Ballast: 2200x950x145 - AEG00352
Pin height: 130 mm	Approved by: Lozanine Sándor
Created: 2020.03.13	Drawn: foctester.sandor - 2020.03.13.13:29:02
Minimum water: 882 liter	Number: W0000713
Water flap: 385 kg	Part: III 1:17
1 person - 75 kg	Page: page 1/1

MAJOR COMPONENTS OF THE PRODUCT

LEO P&P

Tétel	Cikkszám	IR megnevezés EN	Db
1	ACU09245	Spa Pump 1,5 HP - Two Speed 60 Hz	1
2	ACU0926	Floting 1-4 RV Gasket IN 1/2 control	1
3	ACU0952	Control Box IN V2 Caeiro 60Hz V3	1
4	ACU075F	Control Panel IN-C300 - One Pump	1
5	AJ02218	Led housing with seal	14
6	ACU09247	Ozone - Generator (L USA	1
7	ACU0874	Speaker 3" (2 way)	2
8	ACU0875	Gille for speaker 3" (2 way)	2
9	AJU1891	Water Diverter 60 - LED lighted V2	1
10	AJU1892	Air Regulator - house led lighted V2	5
11	AJU0047	Filter House - 60,3 x 60,3 x 5 - Skimmer	1
12	AJU0169	Jet - 20,38 - Ozone 90°	1
13	ABE0409	Suction 2" with nut	1
14	AJU0084	Water Drain - 20 RB V2	1
15	AJU0214	Jet 2" - frontparent 1 Hole transparent V3 Wells	30
16	AJU0216	Jet 3" - frontparent 1 Hole V3 Wells	2
17	AJU0217	frontparent 1 Hole Rotation transparent V3 Wells	4
18	AJU1894	Water Diverter - Grip Wells V2	1
19	AJU1895	Air regulator grip Wells V2	5
20	AFC0042	Pillow - 318 x 113 x 60 - Pol. V2 light grey	3

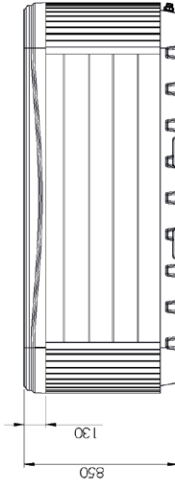
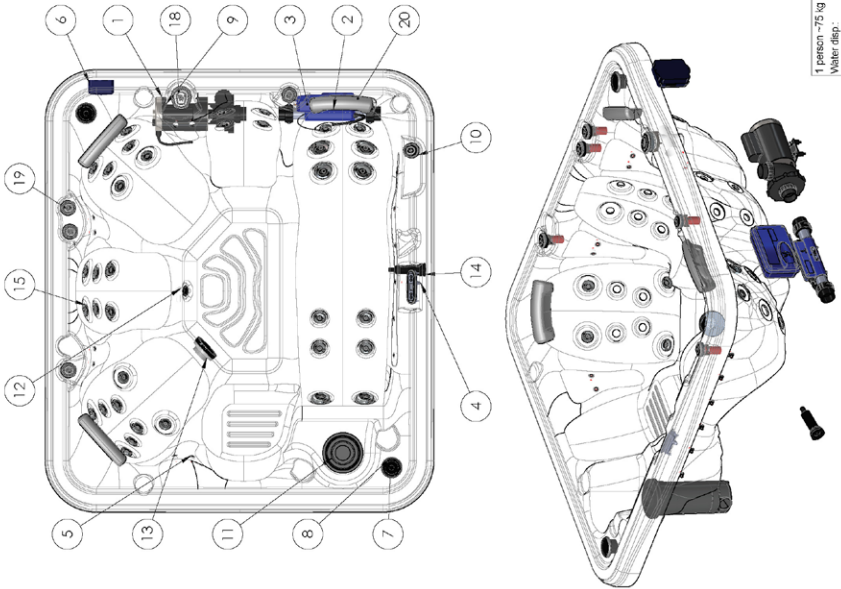

You must install a 30mA Residual-current device (RCD)

Sheet name: WELLS
 File name: E:\W000711_ENG_LEO P&P (536) _mediana USA
 Dimensions SPA - 2150x1900x850 mm | Min. EI: 120 V - 12A - 60Hz / Opt EI: meda: 120V - 12A - 60Hz
 Weight of the SPA - 220 kg | Rating 2100x380V-415 - A/E/0/0/1 | Control box GECKO V2-4300-140V (1H)
 Pin height - 130 mm | Approved by **Lespinaer S&C** | Part No. Number: W0000711
 Created: 2020. 03. 13. | Drawn: test-tuner.sander - 2020. 03. 13. | 13.03.2020 | **A3** | **M 115** | **page 1 / 1**

MAJOR COMPONENTS OF THE PRODUCT

LEO SCANDI PACK

Tétel	Cikkszám	ÍRS megnevezés:BN	DB
1	ACM0735	Spa Pump 3 HP - Two Speed 60 Hz	1
2	ACM0759	Control Panel INJ300 - One Pump	1
3	ACM0952	Control Box INJ2 Gecko 60Hz V3	1
4	ACM0926	Heating 1-4 kW Gecko INJ1 control	1
5	ACM0947	Ozone - Generator UL USA	1
6	ACM0874	Speaker 5" (2 way)	2
7	AKU0047	Filter House - 60,3 S x 60,3 S - Skimmer	1
8	AKU0084	Water Drain - 20 RB V2	1
9	AKU1891	Water Diverter 60 - LED lighted V2	1
10	AKU1892	Air Regulator - House led lighted V2	5
11	AKU1897	Water Diverter - Grip Natural V2	1
12	AKU1898	Air Regulator - Grip Natural V2	5
13	AKU2218	Leak housing with seal	14
14	AE00594	Self-adjustment ring for suction	1
15	AE00620	Silicon gasket for suction 2"	1
16	AE00609	Suction 2" with out	1
17	AJ00169	Jet - 20.38 - Orange 90°	1
18	AJ00214	Jet 2" - transparent 1 Hole transparent V3 Wells	16
19	AJ00216	Jet 3" - transparent 1 Hole V3 Wells	10
20	AJ00217	Jet 3" - transparent 1 Hole Rotation transparent V3 Wells	10
21	AE00027	Pillow Padarms	3

You must install a 30mA Residual-current device (RCD)

Product family: USA Line

Sheet name: WELLS	USA Line	Register	Wells®
File name: FJ_wm00715_ENG_lee_(53-1)_medline_usa			
Dimension SPA: 2150x1900x850 mm	Min. EI: 240 V - 11A - 60Hz / Opt. EI: needs: 240V - 28A - 60Hz		
Weight of the SPA: 220 kg	Control box: GECKO V2 + K300-4KW		
Rim height: 120 mm	Approved by: Losteiner Sándor	Number: WM000715	A
Created: 2020. 03. 16.	Drawn: losteiner.sandor - 2020. 03. 16. - 10:48:39s	A3 M 1:20	page 1 / 1

1 person - 75 kg
Water disp. 375 kg
Minimum water 712 liter

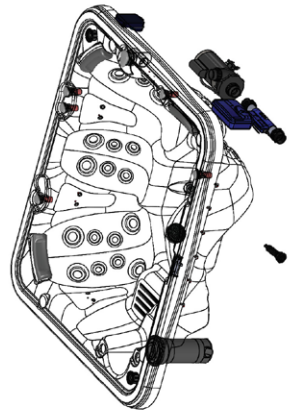
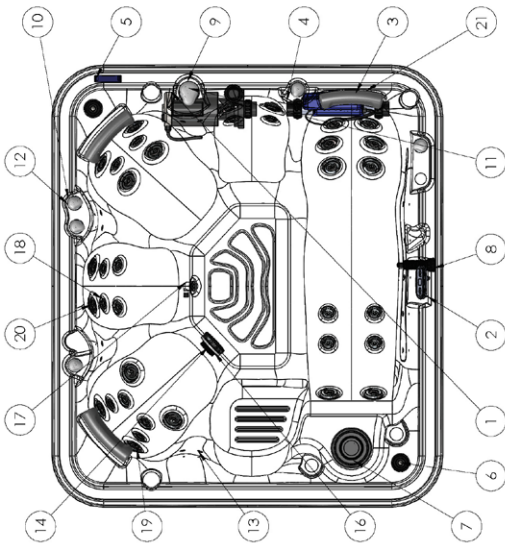

MAJOR COMPONENTS OF THE PRODUCT

ORION P&P

Tétel	Cikkszám	ÍFS megnevezés EN	Dő
1	ACM0945	Spa Pump 1,5-HP - Two Speed 60 Hz	1
2	ACM0926	Heating 1-4 kW GECKO (N,Y) control	1
3	ACM0950	Control Box IN V2 GECKO 60Hz V3	1
4	ACM0959	Control Panel IN V300 - One Pump	1
5	ACM0947	Ozone - Generator UL USA	1
6	ACM0974	Speaker 3" (2 way)	2
7	ACM0975	Grille for speaker 3" (2 way)	2
8	AKU11892	Air Regulator - house led lighted V2	3
9	ASEB409	Suction 2" with nut	1
10	AJ00149	Jet - 20.58 - Ozona 90°	1
11	AKU10047	Filler House - 60.3 S x 60.3 S - Skimmer	1
12	AKU11898	Air Regulator - Opto Natural V2	3
13	AJ00220	Jet 2" - transparent 1 Hole transparent V3 neutral	22
14	AJ00222	Jet 3" - transparent 1 Hole transparent V3 neutral	4
15	AJ00223	Jet 3" - transparent 1 Hole rotational transparent V3 neutral	4
16	AF00042	Fillow - 318 x 113 x 60 - Pal. V2 light grey	2
17	AKU10084	Water Drain - 20 PB V2	1
18	AKU10099	Led Light - Lens V2	10

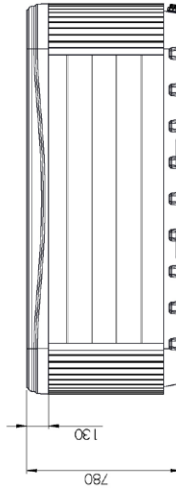

You must install a 30mA Residual-current device (RCD)

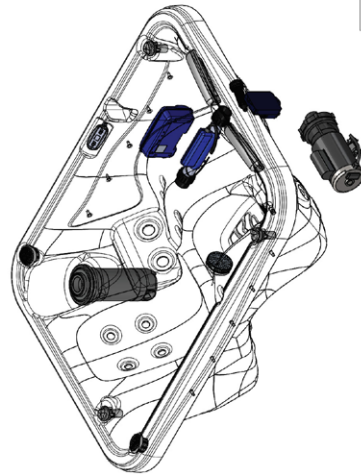

Product family: USA Line

Sheet name: WELLS	USA Line	Registration	WELLS
File name: FJ_W100710_ENG_Orion P&P (30-2L) _mendeusa USA			
Dimension SPA: 2000x1500x780 mm	Min. EI: 120 V - 12A - 60Hz / Opt. EI: needs: 120V - 12A - 60Hz		
Weight of the SPA: 170 kg	Raklap: 1540x880x145 - AE00090	Control box: GECKO V2+H300-1RW (H)	
Rim height: 130 mm	Approved by: Lusteiner Sándor	File Name: W1000710	
Created: 2020. 03. 13.	Drawn: lusteiner.sandor - 2020. 03. 13. - 14.53396szs	A3	M 1:15
			page 1 / 1

1 person - 75 kg	247 kg
Water disp.	497 liter
Minimum water:	

MAJOR COMPONENTS OF THE PRODUCT

ORION SCANDI PACK

Tétel	Cikkszám	IFS megnevezés/EN	Db
1	ACM0735	Spa Pump 3 HP - Two Speed 60 Hz	1
2	ACM0760	Control Panel INJ300 - Two Pump	1
3	ACM0952	Control Box INJ-H2 Gecko 60Hz V3	1
4	AKU1892	Air Regulator - house led lighted V2	3
5	AEO0594	Self adjustment ring for suction	1
6	ABEO409	Suction 2" with nut	1
7	AEO0620	Silicon gasket for suction 2"	1
8	AKU0047	Filler House - 60.3 S x 60.3 S - Skimmer	1
9	AJ00169	Jet 1- 20.3B - Ozone 90°	1
10	AKU0084	Water Drain - 20 RB V2	1
11	ACM0947	Ozone - Generator UL USA	1
12	ACM0874	Speaker 3" (2 way)	2
13	ACM0875	Grille for speaker 3" (2 way)	2
14	AKU1898	Air Regulator - Crisp Natural V2	3
15	AJ00220	Jet 2" - transparent 1 Hole transparent V3 neutral	18
16	AJ00222	Jet 3" - transparent 1 Hole transparent V3 neutral	8
17	AJ00223	Jet 3" - transparent 1 Hole rotational transparent V3 neutral	4
18	AFO0042	Pillow - 316 x 113 x 60 - Pat. V2 light grey	2
19	AKU2099	Led light - Lens V2	10

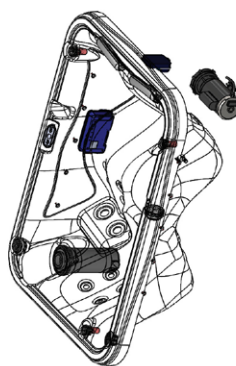
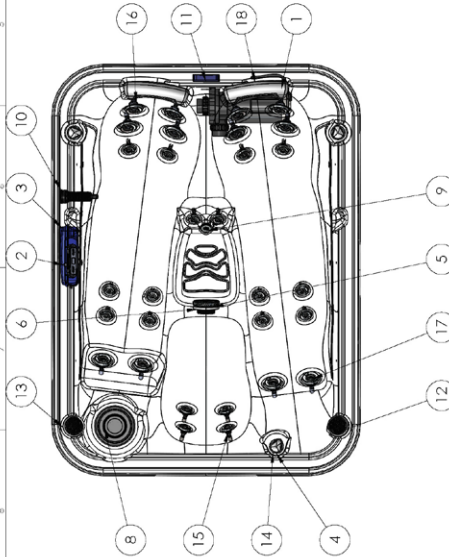

You must install a 30mA Residual-current device (RCD)

Product family		USA Line	
Sheet name:	WELLS	File name:	FJ_WM00716_ENG_Orion_(330-2)_mendeze_USA
Dimension SPA:	2000x1500x780 mm	Min. EI:	RIS: 240 V - 10A - 60Hz / Opt.EI: needs: 240V - 27A - 60Hz
Weight of the SPA:	170 kg	Control box:	GECKO V2 + K300-4KW
Rim height:	120 mm	Approved by:	Losteiner Sándor
1 person-75 kg	225 kg	Number:	WM00716
Water disp.:	497 liter	Created:	2020. 03. 13.
Minimum water:	497 liter	Driver:	losteiner.sandor - 2020. 03. 13. - 1530438-ssz
			A3 M 1/20
			page 1/1

MAJOR COMPONENTS OF THE PRODUCT

RIO GRANDE W-FLOW

Part No.	Item No.	Descriptions	Qty
1	ACM0888	LUV-C set v2	2
2	ACM0768	IK1001Controlpanel	2
3	ACM0769	IN STREAM-2	1
4	ACM0849	Subwoofer 280W	1
5	ACM0968	IN Touch - 2 Ceckle Wifi	2
6	ACM0802	Led control box	2
7	ACM0735	Hydra pump 60 Hz 2200W	2
8	ACM0846	Circulation pump WTC50M 0.33 LE 250W	1
9	ACM0755	Control box IN YE-3	1
10	ACM0925	Heater 4kW	2
11	ACM0776	Control box IN YLS	2
12	ACM0834	Circulation pump for Swim Spa PCF100	1
13	ACM0928	W-flow pump 2 spd. 3 LE	3
14	ACM0881	IN Grid for heat pump	1
14	AKL0084	Water drain for jakuzi	1

A100214 2" Jet 5
A100217 3" Jet 22
A100219 5" Jet 13

Product family: **SwimLine**

You must install a 30mA Residual-current device (RCD)

Electrical need: Spa : min: 240V-21A-60Hz opt:240V-39A-60Hz
Swim : min: 240V-36-60Hz opt:240V-53-60Hz

1 person - 75 kg	1 person - 75 kg
Water disp.: 525 kg	Water disp.: 525 kg
Minimum water: 6615 liter	Minimum water: 6615 liter

Sheet name: RioGrande - 2019 W-Flow
 File name: F3_WU00034_EN_Rio Grande 2019_W-Flow_úszőmedence
 Dimension SPA: 2350x6000x1470 mm | Min.El.rds: 240 V - 55A - 60Hz / Opt.El. needs: 240V - 88A - 60Hz
 Weight of the SPA: 1305 kg | Control box YTB = INLX1000-4KW + GECHO IN YE-3 + INLX1000-4KW
 Fin height: 150 mm | Approved by: László Sándor | P. No. File Number: WU00034
 Created: 2020. 03. 16. | Drawn: István Sándor - 2020. 03. 16. 14:22:08 | A3 | M 1:17 | page 1 / 3

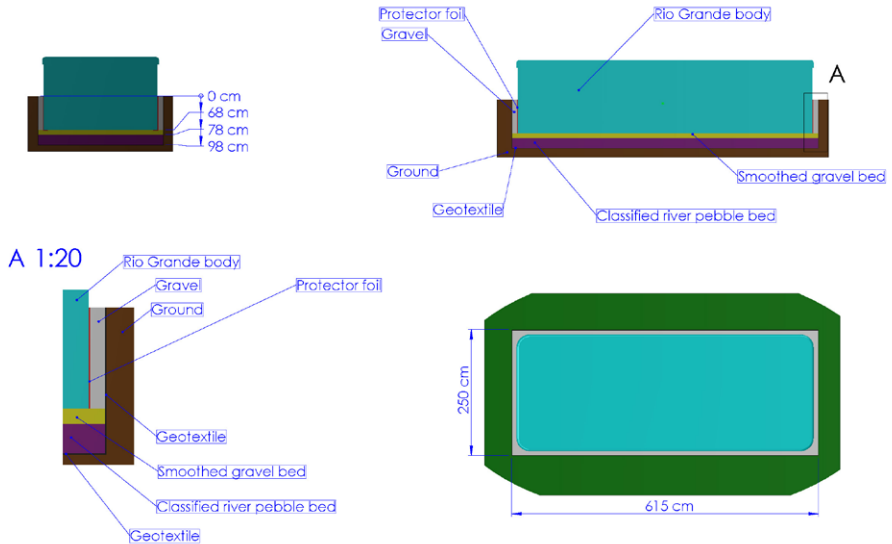

MAJOR COMPONENTS OF THE PRODUCT

AMAZON W-FLOW

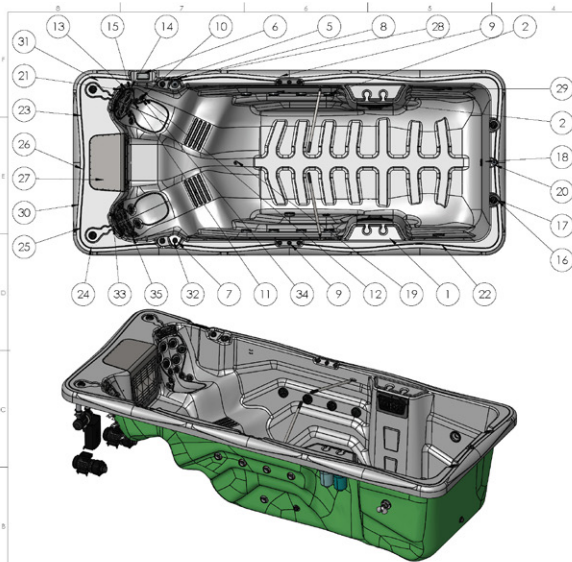

Tétel	Cikkszám	IFS megnevezés EN	Dbb
1	AM01078	Filter House - wall two filters	2
2	ASB0443	Suction 2' chrome thick	12
3	AJ00244	Sealing for self adjusting suction head nut	12
4	AJ00243	Self adjusting nut for suction head	12
5	AJU1892	Air Regulator - house led lighted V2	2
6	ACM0912	Control Panel - INJ1000 V2	1
7	AJU1893	On-Off tap house 33 transparent V2	1
8	AJU1891	Water Diverter 60 - LED lighted V2	1
9	AJU2101	Fountain lamina: V2	6
10	AJ00226	Jet house 2' with sealing	6
11	AJ00237	Nozzle housing nut self-aligning 2' V3 2/3	6
12	AJ00240	Washer for washer housing 2' V3 3/3	6
13	AJ00228	Jet house with sealing 3"	18
14	AJ00238	Nut for 3" Jet V3 2/3	18
15	AJ00241	Washer for 3" Jet V3 3/3	18
16	ACM0874	Speaker: 3" (2 way)	4
17	ACM0875	Grille for speaker 3" (2 way)	4
18	AJU1720	Suction 4b	2
19	AJ00169	Jet- 20 SB - Ozone 90"	1
20	AJU2104	Adapter for swim thera! V2	1
21	AF00045	pillow holder	4
22	AJ00250	Jet 7"	2
23	ACM0774	Control BOX - IN-Y1-B (3kw)	1
24	ACM0893	UV-C Stainless steel house set 60Hz	1
25	ACM0951	Circulation pump 60Hz 1100W (WBE150)	1
26	ACM0929	Countercurrent system 2400W 50Hz (WPK300)	3
27	ASB0418	Countercurrent housing	1
28	ACM0920	Spo Pump 3 HP - One Speed	1
29	AJ00250	Jet 7"	2
30	ACM0849	Subwoofer 288W	1
31	ACM0904	INSTREAM-2 with quick connector	1
32	AJU1896	On-off tap grip: Wells V2	1
33	AF00061	Pillow 330x120x45 white ribbed	2
34	AJ00214	Jet 2' - transparent 1 Hole transparent V3 Wells	6
35	AJ00217	Jet 3' - transparent 1 Hole Rotation transparent V3 Wells	18

You must install a 30mA Residual-current device (RCD)

Sheet name: Amazonas - 2019 Vflow		Product family: SwimLine	
File name: FJ_WU00032_ENG_Amazonas-2019_W-flow_ozszoemedece_USA	Project:		
Dimension SPA: 2350x5500x1470 mm	Min.El. rds: 240 V - 45A - 60Hz / Opt.El. needs: 240V - 62A - 60Hz		
Weight of the SPA: 375 kg	Control box: GECHO YTB + INJ1000 - 4kW		
Water disp.: 375 kg	Flow: 320x120x45 white ribbed	Number: WU00032	
Minimum water: 8036 liter	Flow height: 150 mm	Approved by: Loszteiner Sándor	Number: WU00032
		Created: 2020. 03. 16.	Drawer: loszteiner.sandor - 2020. 03. 16. 14:38:43
			A3 M 1:20 page 1 / 1

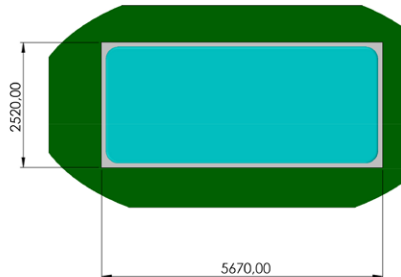
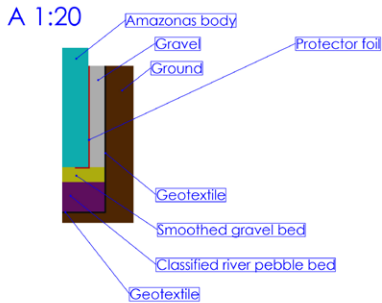
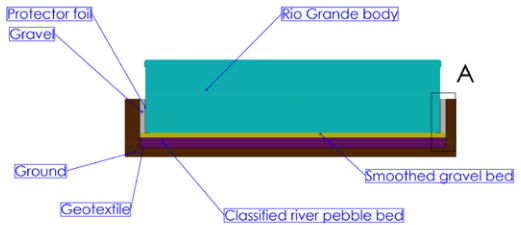
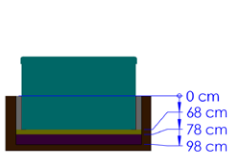

MAJOR COMPONENTS OF THE PRODUCT

DANUBE W-FLOW

16tel	Cikkszám	Írás megnevezés (hu)	Dob
2	AKU1830	Filter house for floating 50 ltr filters	2
3	AKU1893	On-Off tap house 33 transparent V2	1
4	AKU1892	Air Regulator - house led light V2	2
5	AKU2101	Fountain lamina V2	6
6	ABE0421	Suction 2' chrome thick	13
7	AJ00244	Sealing for self adjusting suction head nut	13
8	AJ00243	Self adjusting nut for suction head	13
9	ACM0874	Speaker 3" (2 way)	6
10	AK02137	Adapter for swim Inlet V2	1
11	AJ00228	Jet house with sealing 3"	18
12	AJ00238	Nut for 3" Jet V3 3/3	18
13	AJ00241	Washer for 3" Jet V3 3/3	18
14	AJ00226	Jet house 2" with sealing	6
15	AJ00237	Nozzle housing nut self-aligning 2" V3 2/3	6
16	AJ00240	Washer for washer housing 2" V3 3/3	6
17	AKU1720	Suction 48	2
18	AJ00169	Jet - 20.58 - Ozone 90"	1
19	ACM0912	Control Panel - INK1000 V2	1
23	ACM0080	Spa Pump 3 HP - One Speed	1
24	ACM0276	Control BOX - IN-Y18 (3Rw)	1
25	ACM0834	Circulation pump PCF100 1100 W without prefilter	1
26	ACM0888	UV-C Stainless steel house set	1
28	ACM0928	Counter-current system 2400W 50Hz (WFS00)	3
32	ABE0143	Countercurrent housing 1	1
33	AJ00214	Jet 2" - transparent 1 Hole Rotation transparent V3 Wells	6
34	AJ00217	Jet 3" - transparent 1 Hole Rotation transparent V3 Wells	18
35	ACM0875	Grille for speaker 3" (2 way)	2
36	AKU1896	On-off tap grip Wells V2	1
37	AKU1832	Filter House - Summer Cover round	2
38	AKU1842	Skimmer house with Wells logo	2
39	AKU1895	Air regulator grip Wells V2	2

You must install a 30mA Residual-current device (RCD)

Sheet name: Danube 2019 VFlow
 Product family: SwimLine

Próbák: F3_WU00030_ENG_Danube-2019_W-Flow_ismozomence
 Dimension SPA: 2350x4500x1450 mm | Min.El. rösz: 240 V - 45A - 50Hz / Opt.El. needs: 240V - 62A - 60Hz

Weight of the SPA: kg | Control box: GECHD IN-Y18 + H1000 - 4KW

Water disp.: 75 kg | Film weight: mm | Approved by: **Leitner Sándor** | IN-Y18 Number: WU00030

Minimum water: 9913 liter | Created: 2020. 03. 16. | Drawn: **lesteiner.sandor** - 2020. 03. 16. 13:25:41 | A3 | M:16 | page 1 / 1

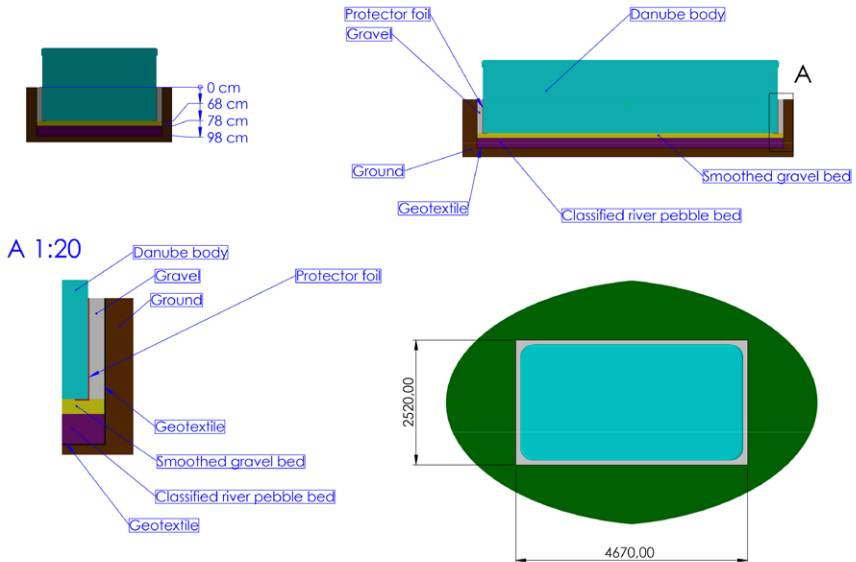

USER INTERFACE - EASY 4

EASY 4

COMPACT FULL-FUNCTION KEYPAD

The Quick Reference Card provides an overview of your hot tub's main functions and the operations accessible from your digital keypad. This QRC depicts a generic overlay, custom versions may vary.

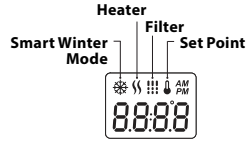

1 PUMP MODEL

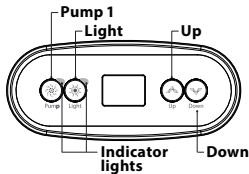

2 PUMP MODEL

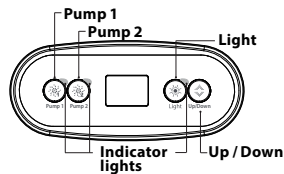

HOT TUB FUNCTIONS



OFF MODE

Pressing Pump 1 for 5 seconds will enable the Off mode. This mode allows you to stop all outputs including automatic functions such as filter cycle, heat request and smart winter mode for 30 minutes to perform quick hot tub maintenance. When Off mode is active, the display will toggle between the "OFF" message, the clock and the water temperature.

The hot tub light will flash for a few seconds before the end of the 30 minutes to warn you that the system is about to resume its normal operation. Press Pump 1 or Pump 2 (if available) to restart the system before the expiration of the 30 minute delay. When the system resumes its normal operation, the display shows "On" for 3 seconds.

PUMP 1

Press Pump 1 key to turn Pump 1 on at low speed. Press a second time to turn pump to high speed (with a dual-speed pump*). A third time turns pump off. A built-in timer automatically turns pump off after 20 minutes, unless pump has been manually deactivated first.

The "Pump 1" indicator lights up when Pump 1 is on. With a dual-speed pump, the indicator will flash when pump 1 is on at low speed.



PUMP 2 KEY

Not available on all models
Press Pump 2 key to turn Pump 2 on at low speed. Press a second time to turn pump to high speed (with a dual-speed pump*). A third time turns pump off. A built-in timer automatically turns pump off after 20 minutes, unless pump has been manually deactivated first.

The "Pump 2" indicator lights up when Pump 2 is on. With a dual-speed pump, the indicator will flash when pump 2 is on at low speed.



LIGHT KEY

Press Light key to turn light on. A second press turns light off. A built-in timer automatically turns light off after 2 hours, unless it has been manually deactivated first.

The "Light" indicator lights up when light is on.



UP/DOWN KEYS

Use Up or Down key to set desired water temperature. The temperature setting will be displayed for 2 seconds to confirm your new selection.

2 pump hot tubs have a combined Up/Down key. Hold the button to increase the parameter and release the button to stop. Hold the button again to decrease the parameter.

The "Set Point" icon indicates that the display shows the desired temperature, NOT the current water temperature!

*If single speed pump: press Pump key to turn pump on. Press Pump key again to turn pump off.

PROGRAMMING STEPS



PROGRAM MENU



The program menu is accessible by holding down the Light key for 5 seconds. In the program menu the following parameters can be set: clock, the filter or purge cycles, economy mode and temperature units. While you are in the program menu, use the Up or Down key to adjust the parameters and use the Light key to jump to the next parameter.

The changes will be saved after the confirmation of the last parameter only. If there is no action taken for 10 seconds, the system will exit the program menu without saving any changes.

SETTING THE CLOCK

Enter the program menu by holding down the Light key for 5 seconds. The display will show the current clock setting with the hour flashing.

Depending on factory settings your system may be set to 24-hour time or 12-hour time.

Setting the hour: Use the Up or Down keys to adjust the hours. Press the Light key to jump to the next parameter, the minutes.

Setting the minutes: Use the Up or Down keys to adjust the minutes. Press the Light key to jump to the next parameter, the filter or purge start time (FS).

PROGRAMMING THE FILTER/PURGE CYCLES

Depending on system configuration your hot tub will perform either a filter or a purge cycle. The filter cycle menu consists of the following parameters: the start time (FS), the duration (Fd) and the frequency (FF). The purge cycle menu consists of the following parameters: the start time (FS) and the frequency (FF).



SETTING FILTER OR PURGE CYCLE START TIME

The display will show FSxx, "xx" representing the starting hour of the cycle. Use the Up or Down key to adjust the hours. Use the Light key to jump to the next parameter, filter duration (Fd).

A filter cycle consists of starting all the pumps and blower in high speed for 1 minute (purge step) then, the pump associated with the filter will run in low speed for the remaining duration of the filter cycle (clean step).

A purge cycle is used when the hot tub is equipped with a 24 hour circulation pump which provides a continuous clean step. It consists of starting all the pumps and blower in high speed for 1 minute.



SETTING FILTER CYCLE DURATION

(not available on purge systems)

The display will show Fdxx, "xx" representing the duration in hours of the filter cycle. Use the Up or Down key to adjust the duration. Use the Light key to jump to the next parameter, filter or purge frequency (FF).

0 = no filtration

24 = continuous filtration

It is not recommended to set this to "0".

SETTING FILTER OR PURGE CYCLE FREQUENCY

The display will show FFxx, "xx" representing the number of cycles per day. Use the Up or Down key to adjust the frequency. Use the Light key to jump to the next parameter, economy mode (EP).

The "Filter cycle" indicator lights up when filter is on and flashes when suspended.

USER INTERFACE - EASY 4



SETTING TEMPERATURE UNIT

Water temperature can be displayed in either Fahrenheit (°F) or Celsius (°C). The display will show F or C.

Use the Up or Down key to change the setting. Use the Light key to save all the parameters.

SMART WINTER MODE

Our Smart Winter Mode protects your system from the cold by turning pumps on several times a day to prevent water from freezing in pipes.

The "SWM" indicator lights up when freezing is detected and flashes when the purge is active.

COOLDOWN

After heating the hot tub water to the desired Set Point, the heater is turned off, but its associated pump (Pump 1 low-speed or CP) remains on for a predetermined period of time to ensure adequate cooling of the heating element, prolonging its useful life.

WATER TEMPERATURE REGULATION

Every 15 to 90 minutes the pump will run to ensure accurate water temperature readings as well as avoid heater activation in dry conditions. After verifying pump activation and taking a water temperature reading if required, the system

automatically turns the heater on to reach and maintain water temperature at Set Point.

 Indicator flashes when taking water temperature reading.

TROUBLESHOOTING SECTION

Should an error occur, the display will show one of the following error messages toggled with the clock and the water temperature.

IN.XE ERROR CODES

DESCRIPTION



Hr
An internal hardware error has been detected in the in.xe.
Contact dealer or service supplier.



HL
The system has shut the heater down because the temperature at the heater has reached 119°F (48°C).
Do not enter the water! Remove the hot tub cover and allow the water to cool down, then shut power off and power your hot tub up again to reset the system.



AOH
Temperature inside the hot tub skirt is too high, causing the internal temperature in the in.xe to increase above normal limits. Open skirt and wait until error clears.



FLO
The system does not detect any water flow while the primary pump is running.
Check and open water valves. Check for water level.
Clean filter. If the problem persists, call your dealer or service supplier.



Prr
A problem is detected with the temperature probe.
Call your dealer or service supplier.



OH
The water temperature in the hot tub has reached 108°F (42°C).
Do not enter the water! Remove the hot tub cover and allow the water to cool down to a lower temperature.
Call your dealer or service supplier if problem persists.

USER INTERFACE - EASY 7

EASY 7 KEYPAD LAYOUT

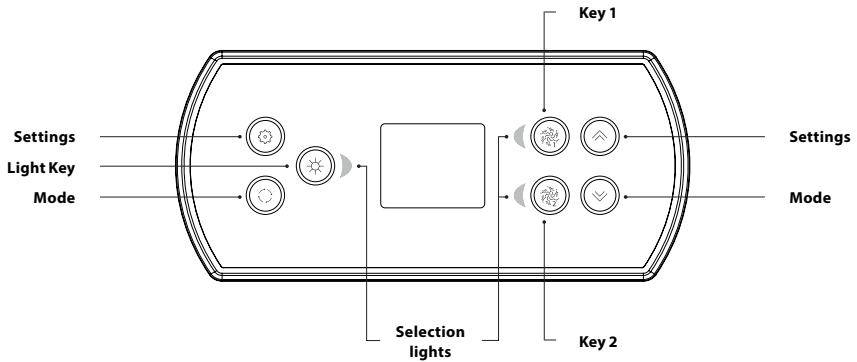

**Functions for keys 1 and 2 will depend on your system's low level configuration.*

SETTINGS KEY

One press gives you access to a menu to manage the settings of your hot tub. Refer to the settings section for details about the settings menu.

MODE KEY

Successive presses on the Mode key will give access to control different optional accessories of your hot tub such as Audio and others. Note that if an accessory is not present in your hot tub configuration, its menu will not appear. Refer to the following section to get details about the possible accessories and their detailed functionalities. The screen will revert back to the hot tub mode if no key is pressed for 60 seconds.

If you don't have any accessories on your hot tub, the Mode key can be used to directly change your display orientation.

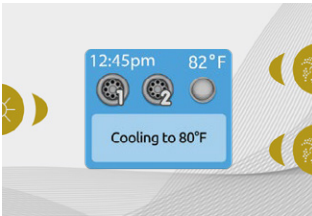

POWER

Press any button to turn the keypad on. After 30 minutes without activity it will shut off.

MAIN SCREEN

The main screen gives you access to your accessories and water temperature. At the bottom of the screen you will see any error or maintenance messages that are present..

USER INTERFACE - EASY 7

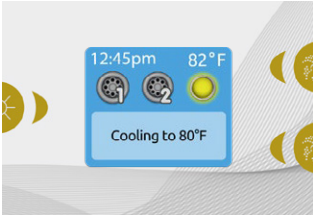

START OR STOP ACCESSORIES

To start or stop an accessory, press the associated button. Icons will become animated when their accessory is turned on, and inanimate when turned off. Icons on the screen will reflect the speed or state of the devices running on your hot tub. When an accessory has more than two states, press the button until it reaches the desired state.

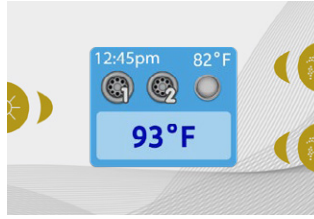

WATER TEMPERATURE

The temperature shown at the top of the screen is the current water temperature. Use the Up and Down buttons to set the desired temperature. The set point will appear in blue at the bottom. After 3 seconds without any change to the set temperature value, the keypad will resume the normal display of messages. When the set value is lower than the current temperature Cooling to xx.x will appear. When the set value is higher than

the current temperature, Heating to xx.x will be indicated. Normally there is a short delay before the heating starts, during which Heating Suspended is indicated.

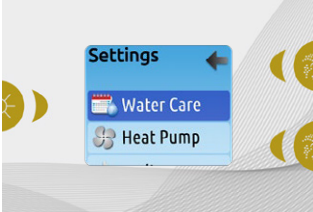

SETTINGS

From the home page you can access the Settings, where you will find:

- Water care
- Heat Pump (if installed)
- Audio (if installed)
- in.clear-200 (linked version)
- Standby
- Maintenance
- Date & time
- Keypad
- Wi-Fi
- Config
- Restore
- About

Use the arrow keys to move up and down in the list. To select an option, press the lit button beside it (Light button).

At any point you can press the Settings button to return to the home screen.

USER INTERFACE - EASY 7

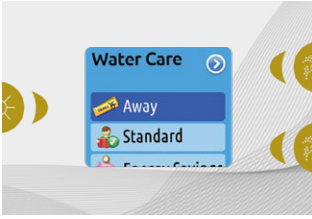

WATER CARE

The Water Care section will help you set up your ideal filtration and heating settings. Choose from Away, Standard, Energy Savings, Super Energy Savings, and Weekender, depending on your need. Use Light key to choose your setting. A checkmark will appear on the selected icon to confirm.

In Economy mode, the set point will be reduced by 20°F*, which means that the heating system will not be engaged unless the temperature falls to 20°F below the hot tub's set temperature.

* Default pack value

WATER CARE MODES



AWAY:

In this mode the hot tub will always be in economy; the set point will be reduced by 20° F*.



STANDARD:

The hot tub will never be in economy mode and will be filtering according to the pack's low level configuration.



ENERGY SAVINGS

The hot tub will be in economy mode during the peak hours of the day and resume normal mode on the weekend*.



SUPER ENERGY SAVINGS:

The hot tub will always be in economy mode during peak hours, every day of the week*.



WEEKENDER:

The hot tub will be in economy mode from Monday to Friday, and will run normally on the weekend*.

* Filtration will be reduced when the economy mode is active.

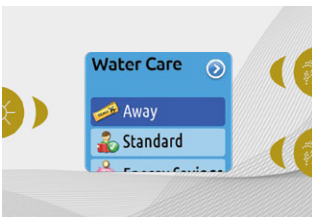

MODIFYING SCHEDULES

To see and/or modify a Water Care category, use the lit button to the right (Key 1) to open the selected Water Care menu.

Use the arrow keys to choose a schedule to modify (choice of economy and filtration schedules). Use the Light key to move between parameters.

You have several possibilities for the schedule (Mon-Fri, weekend, every day, or single days). The schedules will be repeated every week. The time and duration are set in 30 minute increments. Once you have set the schedule, use Key 1 to go back. Ensure that you have selected the desired Water Care option in the main Water Care menu.

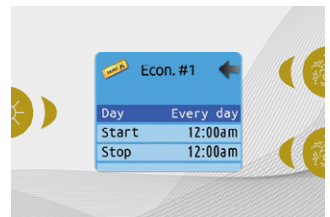

The filtration schedule shown on the screen will apply to the main filtration pump, most likely pump 1. If your hot tub uses a circulation pump configured to run 24 hours, the screen will show you the purge setting instead of filtration. The purges are pre-programmed for a fixed number of minutes, therefore the duration will be set to N/A on the screen, and only the start time can be modified.

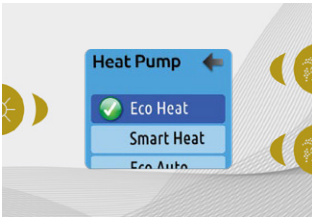

HEAT PUMP

This menu allow you to change the regulation mode of your heat pump. You can choose from Eco Heat, Smart Heat, Eco Auto, Smart Auto, Cool and Electric.

A green checkmark indicates the currently selected regulation mode. To change the setting, simply navigate the menu using the arrow key and press the Light Key to choose the desired regulation mode.

HEAT PUMP MODES



ECO HEAT

In this mode, the heat pump is used as the unique source of heating. The heating element is kept off and the heat pump is not used to cool the water should its temperature rise above the current set point.



SMART AUTO

This mode borrows functionality from both Smart Heat and Cool modes and has the ability to select the proper Heat or Cool mode automatically according to the water temperature. The heating element is activated only if there is a large temperature difference between the water and the set point.



SMART HEAT

This mode uses the heat pump as the main heating source. The heating element is turned on only if there is a large temperature difference between the water and the set point. The heat pump is not used to cool the water in this mode.



COOL

This mode uses the heat pump in cooling mode only. The heat pump is not used as a heating source and the heating element is never activated.



ECO AUTO

This mode borrows functionality from both Eco Heat and Cool modes and has the ability to select the proper Heat or Cool mode automatically according to the water temperature. The heating element is never activated in this mode.



ELECTRIC

This mode keeps the heat pump off and uses only the heating element to regulate water temperature.

USER INTERFACE - EASY 7

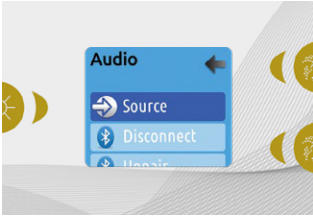

AUDIO

The Easy 7 can be used with the in.tune, in.stream or in.stream 2 audio systems. The Audio section in the Settings menu of an in.stream gives you the option to disconnect or unpair your Bluetooth enabled device when using the in.stream.

With version 7.00 and higher, it is also possible to select Source to use a device connected by auxiliary cable or Bluetooth wireless connection.

The in.stream 2 Settings menu gives you a Source selector, a Bluetooth disconnect option, an On/Off switch and an audio control on fader, balance and subwoofer. For more information on audio functions, see the in.tune, in.stream or in.stream 2 operation section.

The Audio option will only appear in the menu for keypads that are set up for an in.stream connection. The in.stream 2 is automatically detected at power-up.



IN.CLEAR-200 / LINKED VERSION

The Easy 7 keypad can be used with the in.clear sanitization system. The in.clear section allows you to configure your maintenance settings and Boost level. For more information on maintenance and Boost settings, see the in.clear user manual.

Use the Up and Down keys to make your selection, then light key to confirm.

Use the Up and Down keys to change the maintenance or Boost value, and light key to confirm.

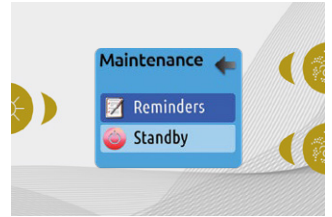

MAINTENANCE

From the Settings page you can access the Maintenance menu, which gives you access to the following options:

- Maintenance reminders
- Standby

Use the Up and Down keys to make a selection, and Light key to confirm.

** If the maintenance value is modified by more than 2, a warning message will appear with an option to cancel or confirm the change.*

USER INTERFACE - EASY 7



MAINTENANCE REMINDERS

The Easy 7 keypad will remind you of maintenance required on your hot tub, like rinsing or cleaning the filter. Each task has its own duration, based on normal use.

The Maintenance reminders menu allows you to verify the time left before maintenance is required, as well as to reset the time once a task is completed.

Use the Up and Down keys to move

through the list.

To reset a task select it by pressing Light key, then confirm when prompted. Once you have confirmed the task will be reset.

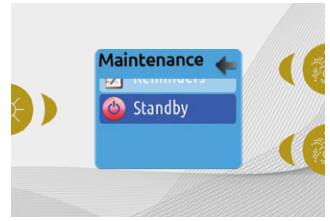

STANDBY

The Standby mode allows you to service your hot tub. Pumps will stop for 30 minutes, and automatically restart after this time.

Once Standby mode has been activated a screen will appear to show that pumps are stopped. The normal hot tub page will return at the end of maintenance.

Press the Key 1 to leave Standby mode and restart the hot tub.

Note: In version 6.00 only, Standby mode is accessible directly from the Settings page.

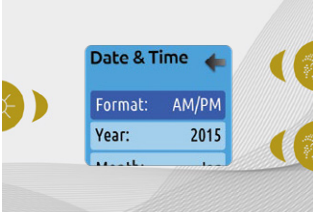

DATE AND TIME

Here you can adjust the time format, change the year, date and time. Use the arrows to choose the setting that you want to adjust, and select it by pressing the Light key.

Use the arrow buttons to change the parameters, and the Light key to move between parameters. Key 1 will take you back to the main Settings menu.

Note: In version 6.00 and earlier, only the day of the week can be changed, and not the year or date.



KEYPAD SETTINGS

In this section, you can change the temperature unit, language, display orientation, rim light color and keypad security. Note the hot tub pack must be configured accordingly to be able to change the rim light color.

When you change the display orientation, the contextual options and arrow keys adjust to the chosen orientation. If you don't have any accessories installed on your hot tub, the Mode key can be used as a display orientation key. Simply press on it to change your orientation from normal to inverted, and vice versa.

Whether the display is inverted or not, the Mode and Menu keys remain unchanged, as well as the accessory keys in the main Hot tub menu.

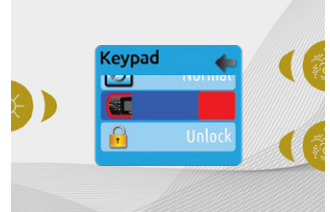

With the Easy 7 equipped with a selectable rim light color modul: If the "RGB backlight" option is enabled in the hot tub configuration an option will appear to allow selection of the keypad rim light color.

You can lock the keypad by selecting one of 3 security levels: Unlock, Partial or Full. The Partial level locks the set point adjustment and many options in the settings menu. The Full level locks all keypad functions. To unlock the keypad (either Partial or Full), press and hold the top right key for 5 seconds.

USER INTERFACE - EASY 7

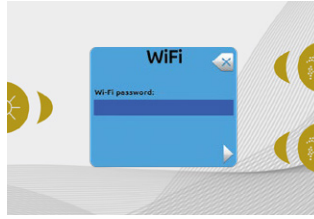
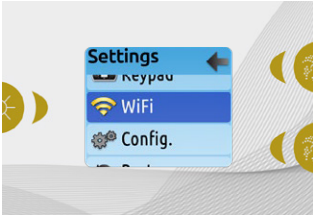

WiFi (IN.TOUCH ONLY)

For the WiFi menu to appear in the Settings menu your in.touch module must be equipped with software version 11.00 or higher. This menu allows you to connect your in.touch module to a WiFi network or to change its network.

For more details about other in.touch connection methods please see the in.touch techbook.

To connect your in.touch module to a wireless network, use the Up/Down keys to go to the WiFi option in the Settings menu and Light key to select it.

After a few seconds the available networks will appear on the screen, as well as their signal strength.

Use the Up/Down keys to move through the list. Select your network by pressing on Light key.

If the WiFi network is password protected enter it when prompted.

- Use the arrow keys to choose your letters and change the type of character (uppercase, lowercase, number, symbol).
- Use Key 2 to move the cursor forward
- Use Key 1 to backspace
- Use Light key to confirm

If no password is required the in.touch will connect automatically.

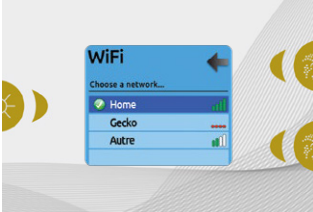

Once the in.touch module is connected to a WiFi network a check mark in a green circle will appear in the WiFi menu, and the network logo will change to green in Settings menu.

Note:

WiFi logo color in Settings menu corresponds to the in.touch connection state.

Yellow = not connected

Green = connected to a network

Yellow with wait icon = connection attempt to a network

Red with wait icon = in.touch no longer detected

(in.touch must be reset before next connection attempt)

USER INTERFACE - EASY 7



CONFIG

Please do not make changes in the electrical configuration section unless you are a qualified electrician.

In this section you can change the low-level configuration, number of phases, input current and heat pump current.

Use Up/Down to move between parameters, and the Light key to select a parameter to change. Please refer to the techBook of your specific control system for hot tub for details about the low level settings.

Once you have changed the Number of Phases in the menu, you will be unable to use the Up/Down keys to return to the Low-level Configuration menu. Please go back and re-enter the Config menu.

Note with version 15.00 and higher: Depending on the pack configuration, a code may be required to change these settings. This code is "5555".

The table below shows the key assignment based on the accessories selected in your pack's low level configuration. Please refer to the Quick Start Card (QSC) for specifications to identify the low level configuration for your hot tub.

POSSIBLE KEY MAPPINGS

Low level configuration	Key 1	Key 2	Light
1 pump	Pump 1	–	Light
2 pumps	Pump 1	Pump 2	Light
2 pumps + blower	Pump 1	Pump 2 + Blower	Light
4 pumps*	Pump 1 & Pump 2	Pump 3 + Pump 4	Light
3 pumps + blower*	Pump 1 & Pump 2	Pump 3 + Blower	Light

*Only pump 1 can have a dual speed.

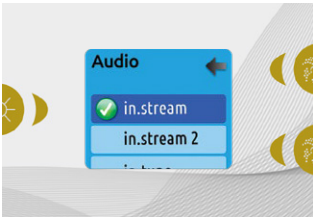

RESTORE/AUDIO CONFIGURATION

When you select Restore you will be asked to confirm your choice. Doing so will reset all settings to factory default.

Following a restore you will be asked to choose your audio source. Use the arrow key to choose between in.stream, in.stream 2, in.tune and no/other audio.

This should only be done at installation or when replacing a part.

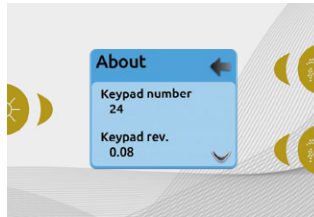

ABOUT

This section shows information about the Easy 7 software number, and the revision numbers of the different components of your system.

IN.STREAM OPERATION

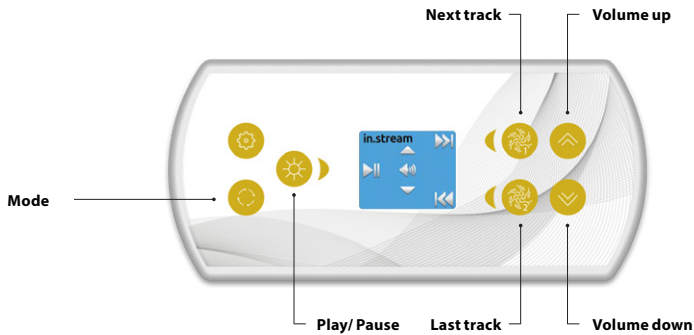

Press the Mode key to access your in.stream.

If you are using a device with Bluetooth technology, it must be connected for functions to work.

Play/Pause audio

Press the Play/Pause button to start or pause the audio.

Adjusting the volume

Press the Up or the Down key to increase or decrease the volume.

Turn power On/Off *(version 7.00 and higher)*

Press and hold the Play/Pause key for 3 seconds to turn the in.stream on or off.

Changing tracks

Use the Last Track and Next Track keys to change tracks.

Disconnect or Unpair Bluetooth

These options can be found under the Audio section in the Settings menu.

IN.STREAM 2 OPERATION

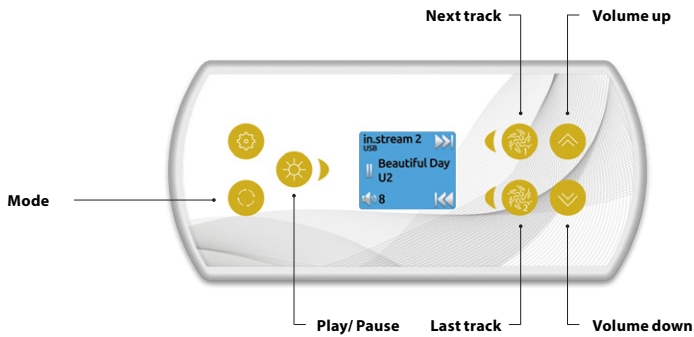

Press the Mode key to access your in.stream 2.

If you are using a device with Bluetooth technology, it must be connected for functions to work.

Play/Pause audio

Press the Play/Pause button to start or pause the audio. This button is available for Bluetooth and USB only.

Adjusting the volume

Press the Up or the Down key to increase or decrease the volume

Turn power On/Off

This option can be found under the Audio section in the Settings menu.

Changing tracks

Use the Last Track and Next Track keys to change tracks or FM stations. This is not available with Aux source.

Disconnect

This option can be found under the Audio section in the Settings menu.

Fader, Balance and Subwoofer

These options can be found under the Audio section in the Settings menu.

IN.CLEAR FUNCTIONS

This menu is only available if an in.clear linked is detected.

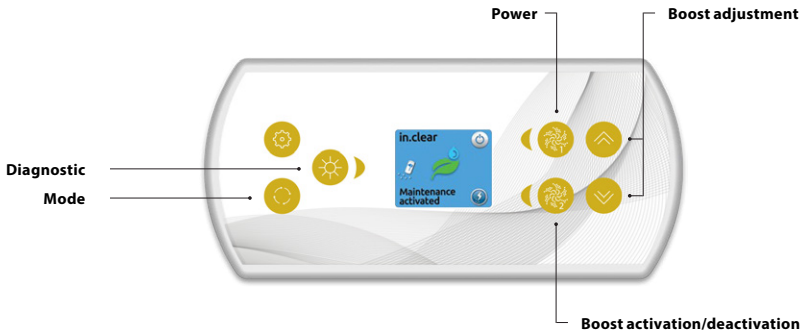

Press on the Mode key to access your in.clear module.

This menu allows you to activate or deactivate your in.clear, to start or stop a Boost, and to enter diagnostic mode.

Turning the in.clear on/off

Press the power key to turn the in.clear on or off.

Control the Boost level

Press on the Boost activation/deactivation key to start a Boost, and again to cancel.

To adjust the Boost level use the arrow keys.*

A message indicating that Boost mode is active is displayed at the bottom of the main screen for the duration of the Boost.

* See the in.clear user manual for more details about Boost levels.

Diagnostic Mode

Press on the Diagnostic key to start a BromiCharge concentration level test. To exit diagnostic mode press on the Diagnostic key again. The system will automatically exit after 15 minutes.

In diagnostic mode, the BromiCharge gauge indicates the approximate level of BromiCharge in the hot tub water. Do not add BromiCharge if the indicator is in the green zone.

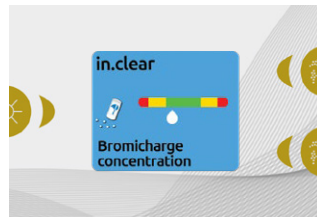

When BromiCharge is added the indicator will move slowly to the right. When water is added to the hot tub the indicator will move to the left. To obtain a good level of BromiCharge, start the pumps and add the specified amount of BromiCharge** and allow 5 minutes for the indicator to adjust before adding more.

For optimal performance, aim for the middle of the green zone.

** For more information on adjusting your BromiCharge level see the in.clear user manual.

USER INTERFACE - EASY 7

ERROR MESSAGES

The list below shows the different error messages that can appear on the home screen. Refer to the troubleshooting and error codes section of the TechBook for your hot tub pack system.

Code	Message
HL	Warning! HL Error
FLO - L01 FLO - L02 FLO	FLO condition - Check filter, pump, blockage, air lock and water level
NO FLO	Persistent NO FLO, all off - Check filter, pump, blockage, air lock and water level
HR	Danger! Relay stuck
OH	Warning! Hot tub temp. high
Pr	Warning! Temp. probes defective
AOH	Internal pack temp. high
FLC	Flow switch closed
SP in	Input voltage issue
RH NC	Comm. error in.xm2 - in.therm
RH ID	in.xm2 - in.therm incompatible
SC ER	Learning mode error
F1	in.xm2 Fuse # 1 is blown
F2	in.xm2 Fuse # 2 is blown
F3	in.xm2 Fuse # 3 is blown
Hr	Danger! Thermal fuse error
UPL	The hot tub pack does not have valid software. Please insert valid in.stick to reprogram hot tub pack.
CFLO	No Flow condition (in.clear)
HIBr	Add fresh water to the hot tub (in.clear)
HiBr	Add fresh water to the hot tub (in.clear)
LoBr	Add BromiCharge to hot tub water (in.clear)
NoBr	Add BromiCharge to hot tub water (in.clear)
Comm	Verify cable connections (in.clear)
Supp	Connect power cord to 240 V source (in.clear)
HP	1-99 Heat Pump error 1-99!

USER INTERFACE - EASY 7

FEATURE MATRIX

The following table presents the features and/or options available for the Easy 7 keypad, and the earliest software version at which this feature/option is available. All versions greater than the earliest version continue to support the feature.

Keypad functions	Earliest support
Power	3.00
Main screen	3.00
Start or stop accessories	3.00
Water temperature	3.00
Settings	3.00
Water care	3.00
Water care modes	3.00
Modifying schedules	3.00
Audio	3.00
in.clear-200 (linked version)	13.00 **
Maintenance	
Maintenance reminders	7.00
Standby	6.00
Date and time	3.00
Keypad settings	
Temperature unit	3.00
Language	
English	3.00
Français	3.00
Español	6.00
Polski	6.00
Nederlands	6.00
Deutsch	6.00
Norsk	6.00
Svenska	6.00
Magyar	10.00
Italiano	10.00
Português	10.00
Česky	14.00
Display	7.00
Color	12.00
Security	15.00
Wi-Fi	7.00*
Electrical configuration	3.00
Factory reset/Audio config.	3.00
in.tune functions	3.00
in.stream functions	3.00
in.stream 2 functions	11.00
in.clear functions	13.00 **
in.mix functions	19.00
Heat pump functions	21.00
White zone 2	3.00
About	3.00

* Only available with the latest software version of the X and Y Series hot tub systems, and software version 11.00 or higher of the in.touch module.

** Only available with the latest software version of the X and Y Series hot tub systems.

USER INTERFACE - SMART TOUCH

SMART TOUCH

TOUCH SCREEN KEYPAD

No buttons, keys and overlays! Mode and function selection wheels, all-on or all-off one touch activation key of last used settings, interactive display icons and on-screen messages are all elements of the Smart Touch user interface designed to let hot tub users interact intuitively with their hot tub and its value-added accessories.

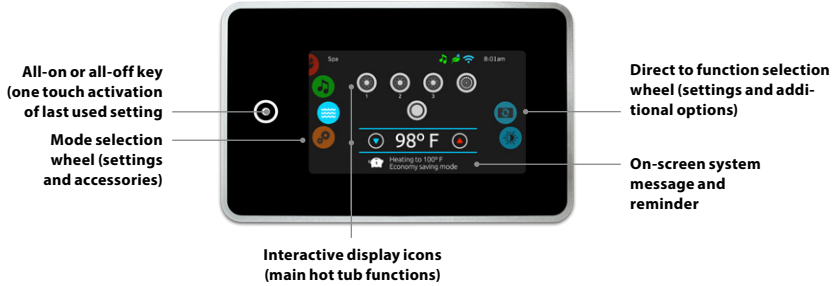

NOTIFICATION ICONS

Notification icons at the top right-hand side of the screen show the status of connected value-added accessories.



HOT TUBS FUNCTIONS

Quick and easy step-by-step instructions to control the main functions and to configure the system settings of your hot tub from its Smart Touch main hot tub keypad.



TURN KEYPAD ON

3 minutes after the last pump is turned off, the screen will shut off if there is no touch activity.

Touch the screen to turn on the keypad. Then follow the instructions on the screen to access the main screen.

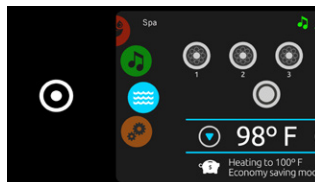

ALL-ON, ALL-OFF TARGET KEY

Smart Touch features an all-on or all-off one touch activation key of last used settings that, when pressed, stops or starts all working components and accessories at once.

From the home page you can access the following modes:

- sanitization (with in.clear connected)
- audio (with Aquasoul Pro connected)
- color (with in.mix installed)
- spa
- settings

To select a mode, slide the left wheel up or down until the desired icon menu is highlighted in the middle.

USER INTERFACE - SMART TOUCH

SPA MODE



SPA MODE

To select the spa mode, slide the left wheel up or down until the spa icon is highlighted in the middle. The home page will be displayed its equipment start or stop keys, up and down buttons, water temperature, messages and quick access to display options:

- display orientation
- display contrast

To select an option, slide the right wheel up or down until the desired icon menu is highlighted in the middle.

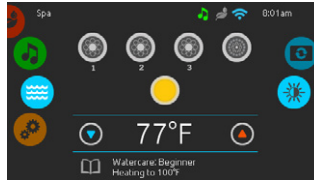

START OR STOP ACCESSORIES

To start or stop an accessory (pump, blower, light), touch the associated icon. Icons will become animated when their accessory is turned on, and animation will stop when turned off.

Icons on the screen will reflect the speed or state of the devices running on your hot tub. When an accessory has more than two speeds press the button until it reaches the desired speed.



WATER TEMPERATURE

The temperature shown at the bottom of the screen shows the current water temperature. Use the Up and Down icon to set the desired temperature. The set point will appear in blue. After 3 seconds without any change to the set temperature value, the current water temperature will reappear.

When the set value is lower than the current temperature Cooling to xx.x will appear below. When the set value is higher than the current temperature, Heating to xx.x will be indicated under the value. Normally there is a short delay before the heating starts, during which Heating Suspended is indicated under the value.

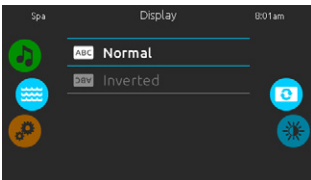

DISPLAY ORIENTATION

To modify the display orientation settings, slide the right wheel until the display orientation icon is highlighted in the middle. Simply touch the line of the orientation you want to select.

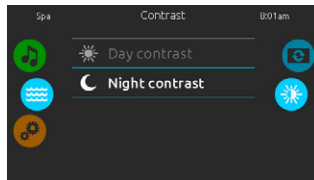

DISPLAY CONTRAST

To modify the display contrast settings, slide the right wheel until the display contrast icon is highlighted in the middle. Simply touch the line of the contrast you want to select.

SWIM SETTINGS



To access your swim hot tub training drills, touch the swimmer icon on the left.

Before choosing one, we recommend to adjust the parameters. Touch the settings icon on the right icon wheel.

From there, you can access 5 different parameters.

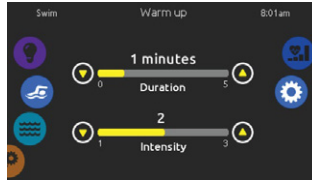

The first one is Warm up. There, you can adjust the duration and intensity of your training warm-up by touching the up and down arrows.

Once done, touch the settings icon to go back to the main settings menu.

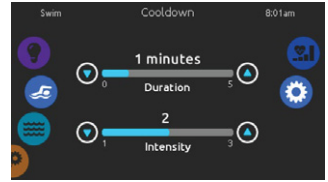

The second one is Cooldown. There, you can adjust the duration and intensity of your training cooldown by touching the up and down arrows.

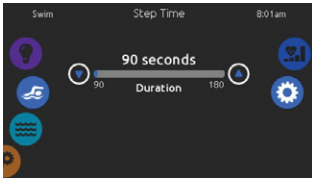

Adjust the training drill Step Time duration by touching the up and down arrows.

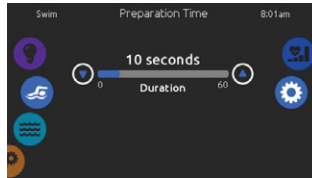

Preparation Time gives you some time to get into swimming position after touching the start button and before the pumps actually start. You can set the duration of your preparation time by touching the up and down arrows.

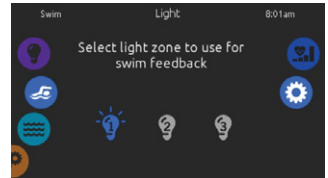

Finally, the light option gives you the possibility to select which in.mix zones you want to use for your swim feedback (requires an installed in.mix)

USER INTERFACE - SMART TOUCH

TRAINING DRILLS - ENDURANCE

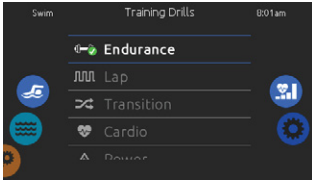

To select a training drill, touch the training drill icon on the top of the right wheel icon.

If you choose Endurance the swimming workout will be executed at a constant intensity for the entire set duration.

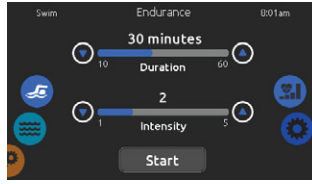

You can adjust the duration and intensity of your Endurance training drill by touching the up and down arrows.

Touch Start when ready.



The preparation countdown is displayed, allowing you to get in position before your swimming session starts. Your in.mix controlled lights will blink during the countdown (requires an installed in.mix). The keypad can be put in sleep mode by touching the sleep icon located at the top right of the screen. It will prevent interruptions of your swim session from water splashing on the keypad display.

You can touch Pause or Stop whenever you need.

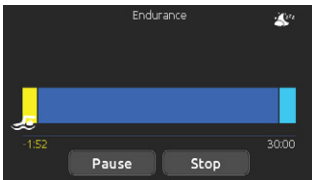

During the workout session, you can follow your progression with the swimmer icon moving toward right over the training duration bar.

You can touch Pause or Stop whenever you need.

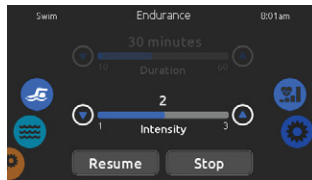

Touch Pause to suspend your swim session. You will be able to change the intensity level of your drill or go in other menus to start the music, for example.

Touch Resume when ready to swim again. The workout session will resume but the preparation countdown stopwatch won't reappear.

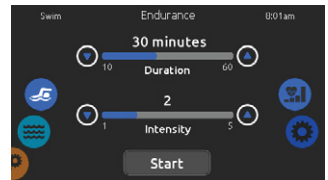

If you touch Stop to interrupt your swim session, you will be able to change the duration and/or the intensity of your session, select another training drill or modify any other parameters.

Touch Start to start your workout from the beginning. The preparation countdown will start.

USER INTERFACE - SMART TOUCH

TRAINING DRILLS - LAP

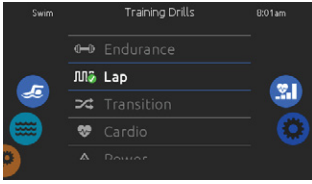

To select a training drill, touch the training drill icon on the top of the right wheel icon.

If you choose Lap, this training drill will perform high and low intensity intervals of equal step time.



You can adjust the duration and intensity of your Lap training drill by touching the up and down arrows.

Touch Start when ready.

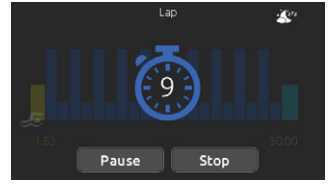

The preparation countdown is displayed, allowing you to get in position before your swimming session starts. Your in.mix controlled lights will blink during the countdown (requires an installed in.mix).

The keypad can be put in sleep mode by touching the sleep icon located at the top right of the screen. It will prevent interruptions of your swim session from water splashing on the keypad display.

You can touch Pause or Stop whenever you need.

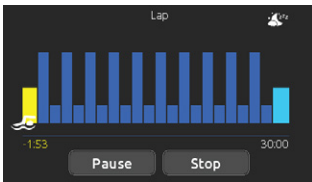

During the workout session, you can follow your progression with the swimmer icon moving toward right over the training duration bar.

Your in.mix controlled lights will change colors before each interval to inform you of the change of intensity (requires an installed in.mix).

You can touch Pause or Stop whenever you need.

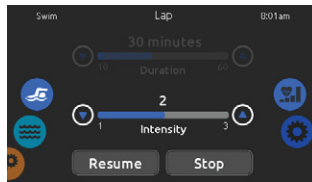

Touch Pause to suspend your swim session. You will be able to change the intensity level of your drill or go in other menus to start the music, for example.

Touch Resume when ready to swim again. The workout session will resume but the preparation countdown stopwatch won't reappear.

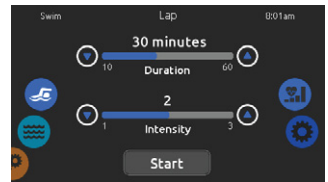

If you touch Stop to interrupt your swim session, you will be able to change the duration and/or the intensity of your session, select another training drill or modify any other parameters.

Touch Start to start your workout from the beginning. The preparation countdown will start.

USER INTERFACE - SMART TOUCH

TRAINING DRILLS - TRANSITION

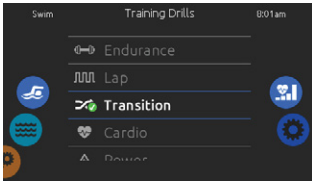

To select a training drill, touch the training drill icon on the top of the right wheel icon.

If you choose Transition, this training drill will perform a series of equal steps at random intensities.



You can adjust the duration and intensity of your Transition training drill by touching the up and down arrows.

Touch Start when ready.



The preparation countdown is displayed, allowing you to get in position before your swimming session starts. Your in.mix controlled lights will blink during the countdown (requires an installed in.mix).

The keypad can be put in sleep mode by touching the sleep icon located at the top right of the screen. It will prevent interruptions of your swim session from water splashing on the keypad display.

You can touch Pause or Stop whenever you need.

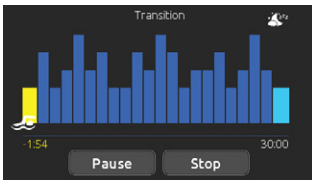

During the workout session, you can follow your progression with the swimmer icon moving toward right over the training duration bar.

Your in.mix controlled lights will change colors before each interval to inform you of the change of intensity (requires an installed in.mix).

You can touch Pause or Stop whenever you need.

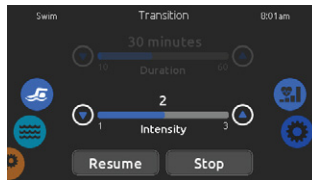

Touch Pause to suspend your swim session. You will be able to change the intensity level of your drill or go in other menus to start the music, for example.

Touch Resume when ready to swim again. The workout session will resume but the preparation countdown stopwatch won't reappear.

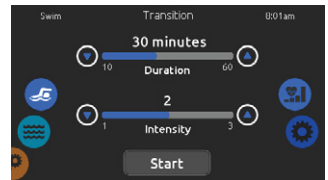

If you touch Stop to interrupt your swim session, you will be able to change the duration and/or the intensity of your session, select another training drill or modify any other parameters.

Touch Start to start your workout from the beginning. The preparation countdown will start.

USER INTERFACE - SMART TOUCH

TRAINING DRILLS - CARDIO

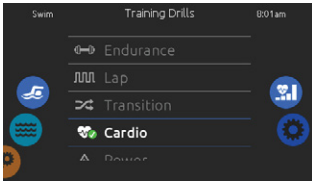

To select a training drill, touch the training drill icon on the top of the right wheel icon.

If you choose Cardio, this training drill will perform two successive steps at high intensity for one step at low intensity.

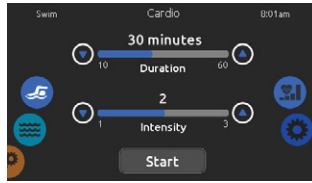

You can adjust the duration and intensity of your Cardio training drill by touching the up and down arrows.

Touch Start when ready.

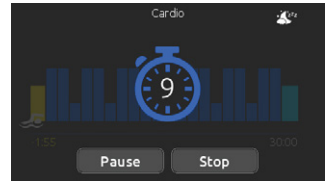

The preparation countdown is displayed, allowing you to get in position before your swimming session starts. Your in.mix controlled lights will blink during the countdown (requires an installed in.mix).

The keypad can be put in sleep mode by touching the sleep icon located at the top right of the screen. It will prevent interruptions of your swim session from water splashing on the keypad display.

You can touch Pause or Stop whenever you need.

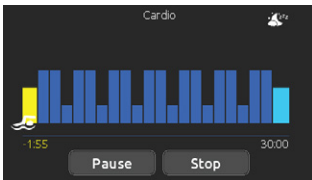

During the workout session, you can follow your progression with the swimmer icon moving toward right over the training duration bar.

Your in.mix controlled lights will change colors before each interval to inform you of the change of intensity (requires an installed in.mix).

You can touch Pause or Stop whenever you need.

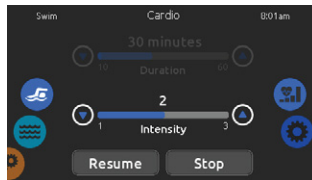

Touch Pause to suspend your swim session. You will be able to change the intensity level of your drill or go in other menus to start the music, for example.

Touch Resume when ready to swim again. The workout session will resume but the preparation countdown stopwatch won't reappear.

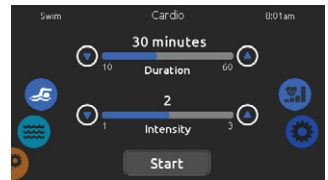

If you touch Stop to interrupt your swim session, you will be able to change the duration and/or the intensity of your session, select another training drill or modify any other parameters.

Touch Start to start your workout from the beginning. The preparation countdown will start.

USER INTERFACE - SMART TOUCH

TRAINING DRILLS - POWER

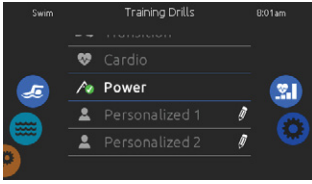

To select a training drill, touch the training drill icon on the top of the right wheel icon.

If you choose Power, this training drill will perform a pyramid program where the intensity will progressively increase until a maximum intensity level is reached. It will then decrease progressively to end at low intensity.



You can adjust the duration and intensity of your Power training drill by touching the up and down arrows.

Touch Start when ready.

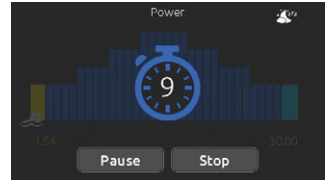

The preparation countdown is displayed, allowing you to get in position before your swimming session starts. Your in.mix controlled lights will blink during the countdown (requires an installed in.mix).

The keypad can be put in sleep mode by touching the sleep icon located at the top right of the screen. It will prevent interruptions of your swim session from water splashing on the keypad display.

You can touch Pause or Stop whenever you need.

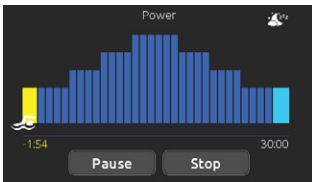

During the workout session, you can follow your progression with the swimmer icon moving toward right over the training duration bar.

Your in.mix controlled lights will change colors before each interval to inform you of the change of intensity (requires an installed in.mix).

You can touch Pause or Stop whenever you need.

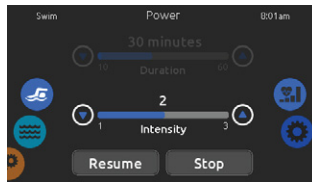

Touch Pause to suspend your swim session. You will be able to change the intensity level of your drill or go in other menus to start the music, for example.

Touch Resume when ready to swim again. The workout session will resume but the preparation countdown stopwatch won't reappear.

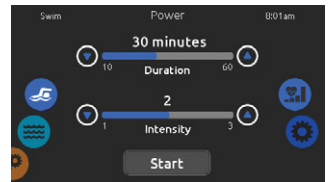

If you touch Stop to interrupt your swim session, you will be able to change the duration and/or the intensity of your session, select another training drill or modify any other parameters.

Touch Start to start your workout from the beginning. The preparation countdown will start.

USER INTERFACE - SMART TOUCH

TRAINING DRILLS - PERSONALIZED

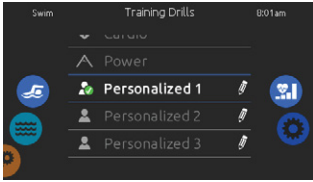

Three personalized training drills are available and can be edited to create custom workouts.

Touch the pencil icon at the right end of the desired personalized drill to open the training drill edit window.

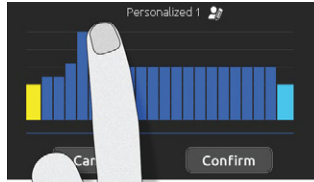

Draw with your finger the desired workout pattern on the screen.

Name your personalized training by touching the pencil icon located at the right of the workout name.



Type your workout name. Once done, touch the return key to get back to the training drill screen.

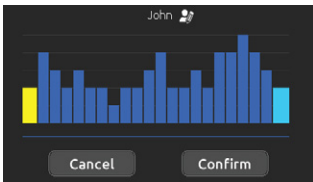

Touch Confirm to save your personalized workout. If you cancel, the modifications will not be saved.

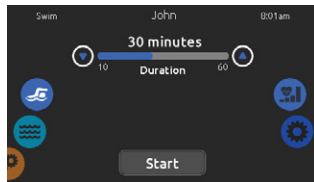

This page allows you to adjust the duration of your personalized training drill by touching the up and down arrows.

Touch Start when ready.

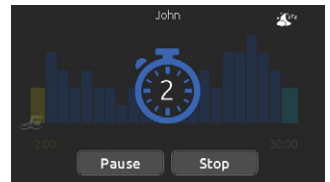

The preparation countdown is displayed, allowing you to get in position before your swimming session starts. Your in.mix controlled lights will blink during the countdown (requires an installed in.mix).

The keypad can be put in sleep mode by touching the sleep icon located at the top right of the screen. It will prevent interruptions of your swim session from water splashing on the keypad display.

You can touch Pause or Stop whenever you need.

USER INTERFACE - SMART TOUCH

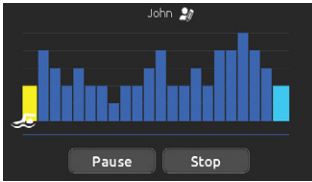

During the workout session, you can follow your progression with the swimmer icon moving toward right over the training duration bar.

Your in.mix controlled lights will change colors before each interval to inform you of the change of intensity (requires an installed in.mix).

You can touch Pause or Stop whenever you need.

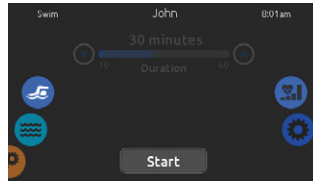

Touch Pause to suspend your swim session.

Touch Resume when ready to swim again. The workout session will resume but the preparation countdown stopwatch won't reappear.

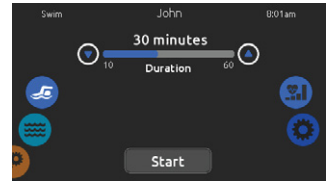

If you touch Stop to interrupt your swim session, you will be able to change the duration and/or the intensity of your session, select another training drill or modify any other parameters.

Touch Start to start your workout from the beginning. The preparation countdown will start.

USER INTERFACE - SMART TOUCH

SETTINGS

You can use the Settings mode to manage settings of your hot tub system.



To select the settings mode, slide the left wheel up or down until the settings icon menu is highlighted in the middle.

In the Settings page you can access the following:

- water care
- maintenance
- date & time
- keypad
- electrical configuration
- wifi
- about

To select an item, slide the right wheel until the desired icon is highlighted in the middle or press on the menu name.

WATER CARE

The Water care page will help you set up your ideal filtration and heating settings.

Choose, set or modify one of the 5 suggested modes depending on your needs at any given time.



AWAY FROM HOME

In this mode the hot tub will always be in economy; the set point will be reduced by 20° F.



BEGINNER

The hot tub will never be in economy mode and will be filtering according to the pack's low level configuration.



ENERGY SAVINGS

The hot tub will be in economy mode during the peak hours of the day and resume normal mode on the weekend.



SUPER ENERGY

The hot tub will always be in economy mode during peak hours, every day of the week.



WEEKENDER

The hot tub will be in economy mode from Monday to Friday, and will run normally on the weekend.

MODIFYING WATER CARE SCHEDULES

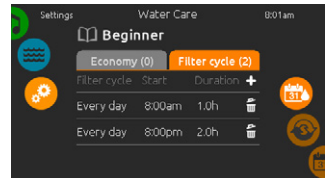
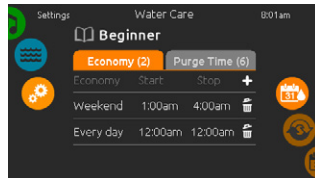
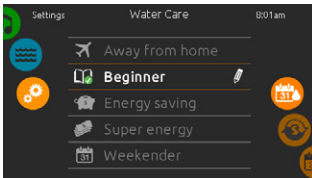

WATER CARE

To modify a Water care category, touch the pen icon at the right end of the desired water care to open the selected Water Care menu.

ECONOMY

Touch the Economy tab to change the economy schedule. You can add economy schedules by touching the « + » symbol . To delete a schedule, touch the garbage can icon at the right end of the desired line.

FILTER CYCLES

Touch the Filter cycle tab to change the filter cycle schedules. You can add filtration schedules by touching the « + » symbol . To delete a schedule, touch the garbage can icon at the right end of the desired line.

USER INTERFACE - SMART TOUCH

MODIFYING WATER CARE SCHEDULES

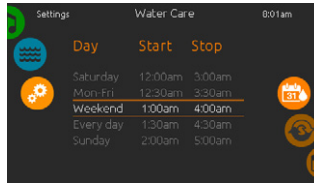

In Economy mode, the set point will be reduced by 20°F, which means that the heating system will not be engaged unless the temperature falls to 20°F below the hot tub's set temperature.

The filtration schedule shown on the screen will apply to the main filtration pump, most likely pump 1. If your hot tub uses a circulation pump configured to run 24 hours, the screen will show you the purge setting instead of filtration. The purges are pre-programmed for a fixed number of minutes, therefore the duration will be set to N/A on the screen, and only the start time can be modified.

You can modify the programmed schedules by selecting one and adjusting the schedule.

You have several possibilities for the schedule (Mon-Fri, weekend, every day, or single days). The schedules will be repeated every week. The time and duration are set in 30 minute increments.

Once you have set the schedule, use the calendar icon to go back.

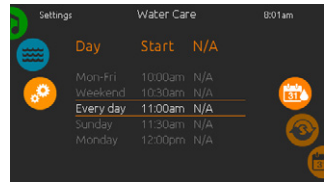
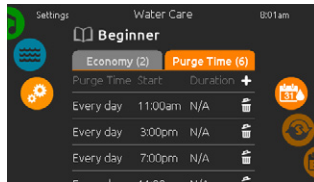

PURGES

Touch the Purge tab to change the purge settings. You can add purges by touching the « + » symbol.

To delete a schedule, touch the garbage can icon at the right end of the desired line.

You can modify the programmed purges by selecting one and adjusting the schedule.

You have several possibilities for the schedule (Mon-Fri, weekend, every day, or single days). The schedules will be repeated every week. The time and duration are set in 30 minute increments. Once you have set the purge, use the calendar icon to go back.

USER INTERFACE - SMART TOUCH

MAINTENANCE & ERROR LOG

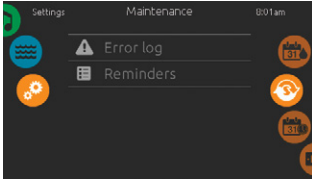

MAINTENANCE

To modify maintenance settings, slide the right wheel until the maintenance icon is highlighted in the middle.

From the Maintenance page you can access the following:

- Error log
- Reminders

Simply touch the line of the item you want to change.

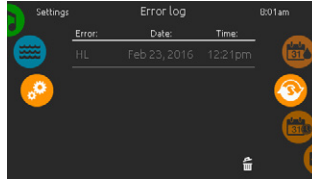

ERROR LOG

Errors are archived by the system. Drag the list Up and Down to move through the list. Errors are archived chronologically, from the most recent at the top to the oldest at the bottom.

The Error log page shows the error code, the date of the error, and the time.

Touching the garbage can icon will delete the Error log (with a confirmation).

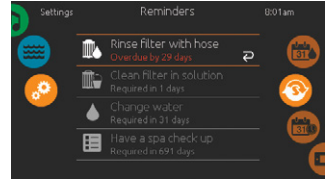

REMINDERS

Smart Touch keypad will provide reminders about maintenance required on your hot tub, like rinsing or cleaning the filter. Every task has its own duration, based on normal use.

The reminders menu allows you to check the time left before maintenance is required, as well as to reset the time once a task has been completed.

To reset a task, select it by pressing the curved arrow, then confirm when prompted. Once you have confirmed, the task will be reset.

DATE AND TIME

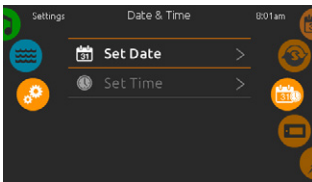

DATE AND TIME

To modify date and time settings, slide the right wheel until the date and time icon is highlighted in the middle.

Simply touch the line of the item you want to change.

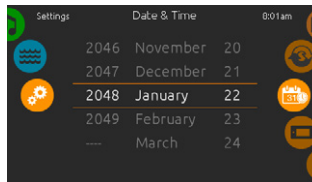

SET DATE

Here you can adjust the year, month and date. Simply swipe up and down the column you want to change, and select the desired value. When done, touch the calendar icon at the right of the screen.

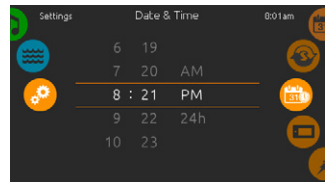

SET TIME

Here you can change the hour, minute and time format. Simply swipe up and down the column you want to change, and select the desired value. When done, touch the calendar icon at the right of the screen.

USER INTERFACE - SMART TOUCH

KEYPAD SETTING

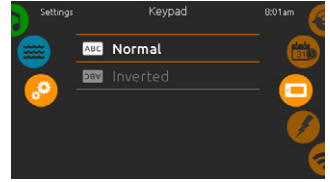
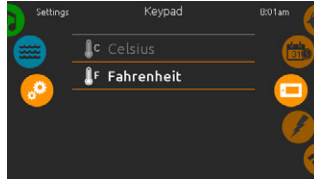
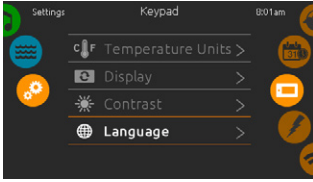

KEYPAD SETTINGS

To modify keypad settings, slide the right wheel until the keypad icon is highlighted in the middle.

Simply touch the line of the item you want to change.

TEMPERATURE UNITS

Use this page to set or change the temperature in F° or C° units.

DISPLAY ORIENTATION

Use this page to set or change the normal or inverted display orientation.

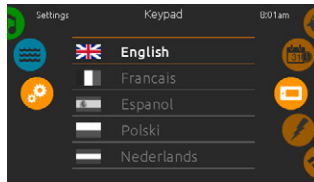
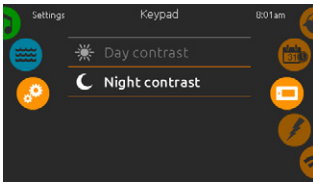

DISPLAY CONTRAST

Use this page to set or change the display day or night contrast.

DISPLAY LANGUAGE

Use this page to set or change the display language.

KEYPAD LOCK/UNLOCK (OPTIONAL)

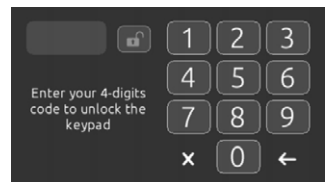
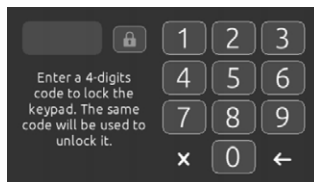
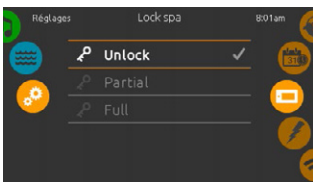

When this option is enabled, the user can partially or completely lock the keypad. When the user wants to lock the keypad he is asked to select a 4-digit code. The same code will be needed to unlock the keypad. Next time he wants to lock the keypad, he will be prompted again to select a 4-digit code (same functionality as a Safe in a hotel room).

The keypad can be unlocked with a universal unlock code (3732) or by a reset of the keypad.

When Full Lock is selected, all functions are locked.

In Partial Lock, you may only activate accessories. Settings may not be changed in this mode.

KEYPAD COLOR (OPTIONAL)

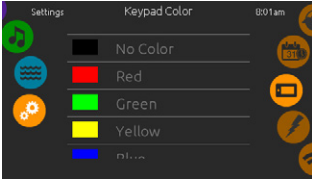

If this option is available (depending on the hot tub configuration), the keypad rim color can be changed. 8 pre-defined colors are available. If the in.mix is installed, the keypad rim color can also be associated to an in.mix zone.

WIFI

(This function is available only if an in.touch module is connected to your system.)

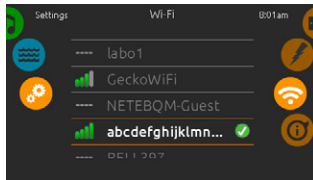
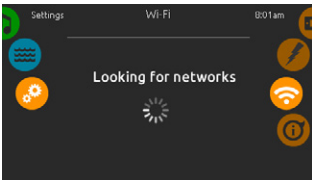

WIFI SETTINGS

To modify wifi network settings, slide the right wheel until the wifi icon is highlighted in the middle.

WIFI NETWORKS

After a few seconds the available networks will appear on the screen, as well as their signal strength.

Selected network will be identified by a green check mark.

Swipe Up or Down the list to select your network.

WIFI NETWORK PASSWORD

If the wifi network is password protected, enter it when keyboard prompts. Use Enter key to validate the password.

If no password is required the in.touch will connect automatically.

USER INTERFACE - SMART TOUCH

WIFI



IN.TOUCH MODULE NOT CONNECTED

If the in.touch module of your hot tub system is not connected, this message will be displayed.

WI-FI (IN.TOUCH 2)

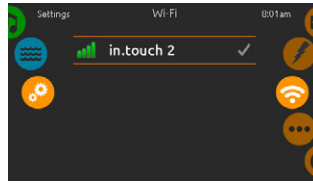

When an in.touch 2 is detected, this network will appear.

MISCELLANEOUS

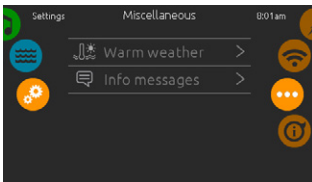

This menu gives access to modify the Warm Weather option and info messages in the media center.

WARM WEATHER

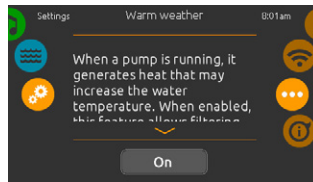

The Warm weather option allows you to bypass the pack filtration over-temperature feature. When Warm weather is Off, the filtration over-temperature is disabled. This feature allows the hot tub to continue filtering even though the water temperature is high.

INFO MESSAGES

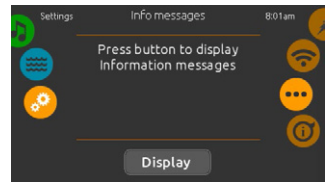

When pumps are running, they produce heat that may increase your water temperature. "Warm Weather" option gives you the option to bypass the pack filtration over-temperature feature. When Warm Weather is "OFF" the filtration over-temperature is disabled and your hot tub filtering will continue even if the water temperature is high.

ABOUT

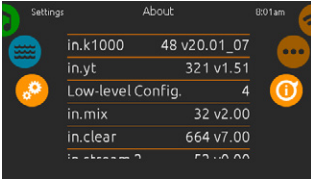

This section shows information about the in.k1000 software number and the revision numbers of the different components of your system.

ELECTRICAL CONFIGURATION

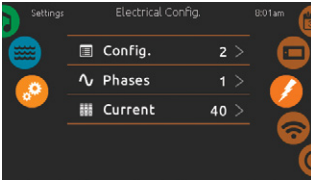

Please do not make changes in this section unless you are a qualified electrician.

A password will be required. Please contact a representative in order to obtain that password.

To change the low-level configuration, the number of phases and the input current of your hot tub system, slide the right wheel until the electrical configuration icon is highlighted in the middle.

USER INTERFACE - SMART TOUCH

AUDIO MODE

(only available if the system detects a connected Aquasoul Pro audio station)



To select the audio mode, slide the left wheel up or down until the audio icon menu is highlighted in the middle.

In the Audio page you can access the following:

- Aquasoul Pro on/off
- speaker calibration
- audio source selector
- bluetooth pairing

To select an item, slide the right wheel until the desired icon is highlighted in the middle.

ON/OFF

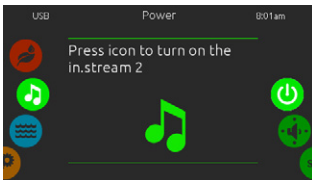

TURN AQUASOUL PRO ON

Slide the right wheel until the power on/off icon is highlighted in the middle. Press on the audio icon at the center of the screen to turn Aquasoul Pro on.

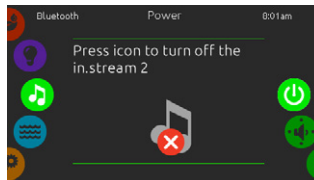

TURN AQUASOUL PRO OFF

Press on the audio icon in the center of the screen to turn Aquasoul Pro off.



MAIN DISPLAY

Press Play / Pause to start or pause playback of audio files.

Drag the volume slider to adjust the volume or tap the mute button to mute or unmute sound.

Press the last track or next track buttons to go to the previous song or skip to the next.

USER INTERFACE - SMART TOUCH

SPEAKER CALIBRATION

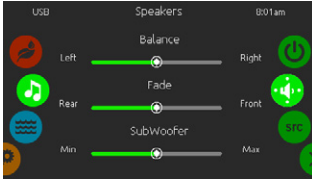

TO CALIBRATE YOUR SPEAKERS

Slide the right wheel until the speaker calibration icon is highlighted in the middle.

You can calibrate:

- balance
- fade
- subwoofer

Use the sliders to calibrate the speakers at the desired level.

The fade and subwoofer sliders will only appear on the screen if the corresponding speakers are installed on Aquasoul Pro.

AUDIO SOURCE SELECTOR

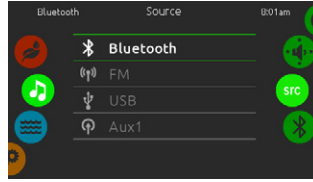

TO SELECT AN AUDIO SOURCE

Slide the right wheel until the source icon is highlighted in the middle.

In the menu list, the following sources are available:

- Bluetooth
- FM
- USB
- Aux. 1

Simply select the desired one to use.

Note that only the sources installed on Aquasoul Pro will be displayed in the source menu.

Please note that the Play/Pause and Change Track functions apply to devices using Bluetooth technology and USB, and will not work when AUX is selected as the source.

Please refer to the Aquasoul Pro connexions section to learn how to connect your Bluetooth device.

BLUETOOTH PAIRING

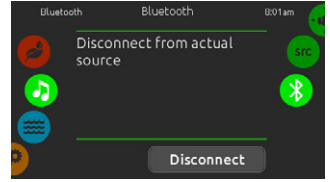

If you are using a device with Bluetooth technology, it must be connected for functions to work.

Slide the right wheel until the bluetooth icon is highlighted in the middle. Then follow the instructions displayed on the screen.

If a device with Bluetooth technology is connected to Aquasoul Pro, you can disconnect it by pressing the Disconnect button at the bottom of the screen.

Doing so will also prevent Aquasoul Pro from automatically reconnecting to this specific device until it has been reconnected using the device itself.

SANITIZATION MODE

(only available if the system detects a connected in.clear water sanitation system)

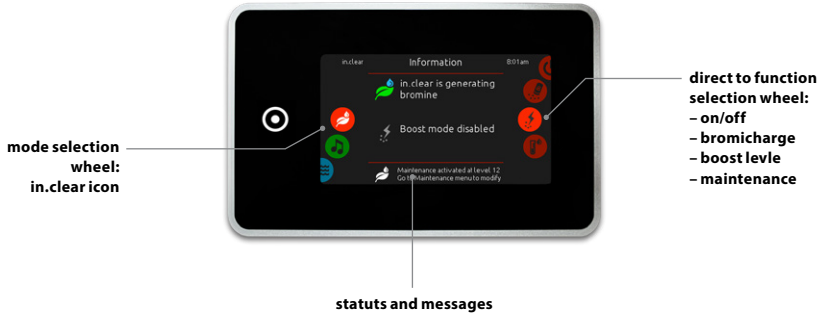

To select the sanitization mode, slide the left wheel up or down until the in.clear icon menu is highlighted in the middle.

In the sanitization page you can access the following:

- in.clear on/off
- bromicharge
- boost level
- maintenance level

To select an item, slide the right wheel until the desired icon is highlighted in the middle.

ON/OFF

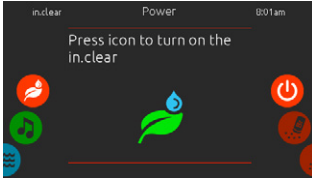

TURN IN.CLEAR ON

Slide the right wheel until the power on/off icon is highlighted in the middle. Press on the in.clear icon to turn in.clear on.

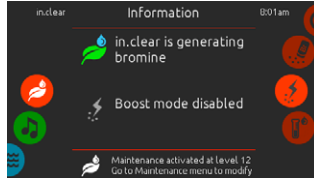

IN.CLEAR ACTIVITY SCREEN

The in.clear activity info screen will appear on the display.

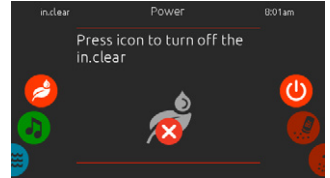

TURN IN.CLEAR OFF

Press on the power on/off icon to turn in.clear off.

BROMICHARGE™ LEVEL

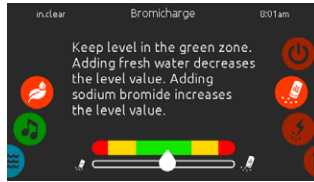

When performing a test, the BromiCharge™ gauge indicates the approximate sodium bromide level of the hot tub water.

To perform a water test, slide the right wheel until the add BromiCharge™ icon is highlighted in the middle.

There is no need to add sodium bromide if the indicator is in the green zone.

When adding sodium bromide, the gauge indicator will gradually shift to the right. When adding clean water to the hot tub, the indicator will shift to the left.

In order to achieve the proper level, start pumps and add 227g (.5 lb) of BromiCharge™ at a time and always allow 5 minutes for the gauge to react before adding more sodium bromide.

The green zone in the center area of the gauge should be targeted for optimal performance.

BOOST LEVEL

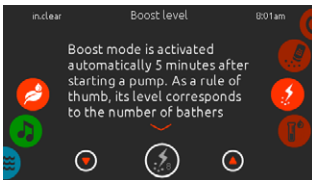

MODIFY THE BOOST LEVEL

Boost mode is activated automatically 5 minutes after starting a pump. Boost mode increases the bromine generation rate to keep the water clear, clean and soft. As a rule of thumb, its level correspond to the number of bathers.

To modify the boost level, slide the right wheel until the boost icon is highlighted in the middle and use the up or down arrow keys to adjust the level.

Click on the the level icon to confirm your selection.

MAINTENANCE LEVEL



Use a test kit to check the bromine level. It should be between 3-5 ppm. If the bromine level stays within that range for 3 consecutive days, your maintenance level is well adjusted.

MODIFY THE MAINTENANCE LEVEL

To verify or modify the maintenance level, slide the right wheel until the maintenance icon is highlighted in the middle.

The recommended maintenance level is 12.

Use the up or down arrow keys to adjust the level.

Note that the level can be adjusted by increment of 2 using the up and down arrow keys.

If you do, retest the bromine level the day after. If the bromine is not in the 3-5 range and is higher than 5 ppm, decrease the maintenance level. If the bromine is lower than 3 ppm, increase it. Repeat until the test reads a bromine level in the 3-5 range.

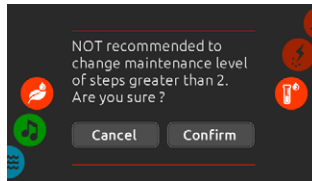

Please note that it is not recommended to change the maintenance level at steps greater than 2.

A confirmation will be asked by the system if you do.

USER INTERFACE - SMART TOUCH

COLOR MODE

(only available if the in.mix is detected among the hot tub accessories)

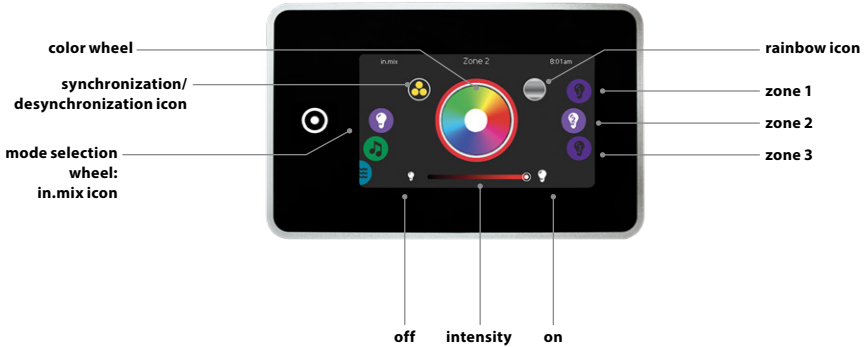

By default, the in.mix selects Zone 2 when you access the menu. To select the color mode, slide the left wheel up or down until the in.mix icon menu is highlighted in the middle.

In the color page you can access the following:

- zone selection
- synchronizing zones
- changing colors
- intensity
- on/off

IN.MIX FUNCTIONS

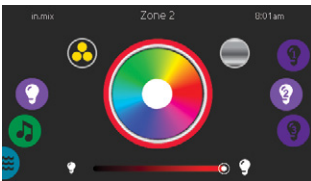

ZONE SELECTION

To select a zone, turn the right wheel until the desired icon is highlighted in the middle. This selection allows you to modify its color.

CHANGING COLORS

Once a zone has been selected, use the color wheel to choose the desired color, or the rainbow icon to get changing colors.

The rainbow icon alternates between slow transitions, fast transitions and normal color selection.

ON/OFF

There are two ways to turn the in.mix on or off. The first one is by using the Light icon on the SPA Screen. The second way is by touching the light bulb icons located each side of the intensity bar.

SYNCHRONIZING ZONES

The synchronization/desynchronization icon allows you to match the color of the selected zone with the other zones.

INTENSITY

Located at the bottom of the screen, the slider allows you to modify the intensity of the color.

TOO MUCH WATER ON DISPLAY



WIPE SCREEN

This message appears when too much water is detected on the touch screen. Simply wipe away excess water.

INSTALLATION ERROR MESSAGES

Upon connecting Smart Touch to your hot tub system you may see one of two error messages. Please follow the instructions in the message or contact your dealer for more information.

WARNING

There's a problem communicating with the pack. Please check keypad connections or update pack software.

Upload

The spa pack does not have valid software. Please insert valid in.stick to reprogram spa pack.

Error messages on the screen list and definitions:
<http://geckokeypads.com/k1000errormessages>

4 BUTTON PANEL

AUXILIARY KEYPAD FOR YOUR HOT TUB

The 4 button panel is an auxiliary keypad designed to be installed as a second keypad on your hot tub.

It allows you to run the accessories while staying comfortably seated in your hot tub.

Its surface mount allows for an easy installation in different locations around your hot tub.

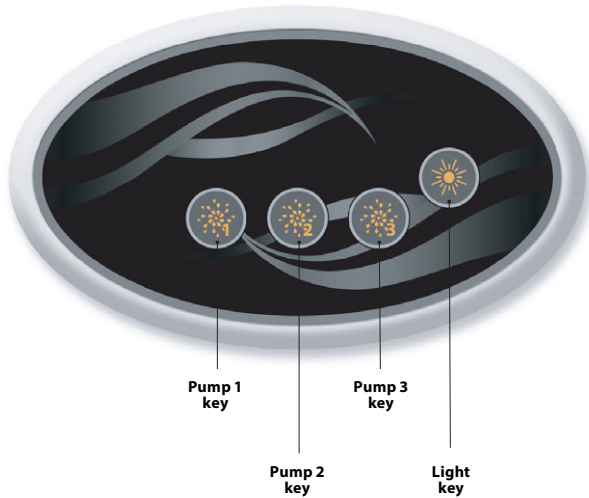

ONE SINGLE BUTTON PANEL

AUXILIARY KEYPAD FOR YOUR HOT TUB

This one single button panel is also an auxiliary keypad designed to be installed as a second keypad on your hot tub.

It allows you to activate the hot tub pump associated to its respective section.

The panel surface allows for an easy installation in any location around your hot tub.



OPTIONAL ACCESSORIES - AQUASOUL PRO

AQUASOUL PRO

AUDIO STATION FOR HOT TUBS



Aquasoul Pro audio system offers you the perfect means to bring music into your hot tub. Aquasoul Pro is simple to install and compatible with numerous audio sources. For example, you may connect Aquasoul Pro to an iPod using the auxiliary audio input or play music wirelessly using a Bluetooth mobile device. Listen to music in MP3 format saved on a USB flash disk or tune in to an FM station of your choice using the Aquasoul Pro integrated FM receiver. Depending on the configuration used, Aquasoul Pro can handle up to 4 speakers and one subwoofer.

The audio station can be used to charge most mobile devices on the market with its onboard USB charger controller.

Powered with its own internal universal power supply, Aquasoul Pro can be used in any place in the world. All the electronics circuits are contained in a innovatively designed and splashproof plastic enclosure.

Aquasoul Pro is equipped with state of the art class D audio amplifiers. This type of amplifier is very power efficient and dissipates much less heat than any comparable audio system for use in hot tub.

Depending on the selected configuration, Aquasoul Pro conveniently lets you control music from the main keypad or may be used as a stand-alone.

Main characteristics

- Fully splashproof (IPx5)
- Integrated universal power supply
- 1 auxiliary input
- Compatible USB port
- Integrated FM receiver with external antenna
- Bluetooth receiver
- Mobile device USB charger controller
- Up to 4 speakers and one subwoofer

OVERVIEW



OPTIONAL ACCESSORIES - AQUASOUL PRO

Depending on the chosen configuration, Aquasoul Pro can support up to 4 speakers, 1 subwoofer, an auxiliary input, a USB connection with 1A charging capability, FM radio receiver and Bluetooth streaming.

The in.p4 waterproof enclosure, which provides protection to your iPod or smart phone, is available as an option.

With a compatible keypad, you will have full control over the Aquasoul Pro features from inside of your hot tub.

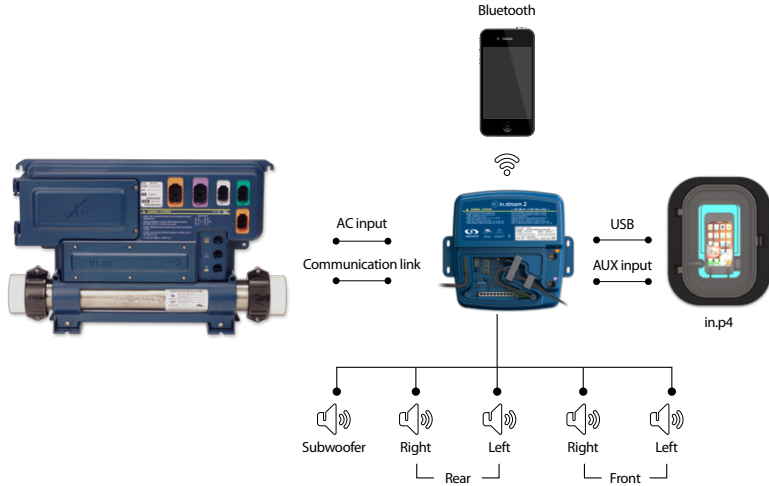

CONNECTIONS

PREPARATION



TO PREVENT ELECTRIC SHOCK HAZARD, DO NOT CONNECT TO MAIN POWER SUPPLY WHILE THE COVER IS REMOVED.



Remove the cover screws from the front of the apparatus with a Phillips screw driver.



Remove cover and put aside the foam gaskets located in the wire channel.

OPTIONAL ACCESSORIES - AQUASOUL PRO

CONNECTIONS

CONNECTING THE SPEAKERS AND SUBWOOFER



Connector pins	Identification
1	Front Left speaker (+)
2	Front Left speaker (-)
3	Front Right speaker (-)
4	Front Right speaker (+)
5	Rear Left speaker (+)
6	Rear Left speaker (-)
7	Rear Right speaker (-)
8	Rear Right speaker (+)
9	Subwoofer (+)
10	Subwoofer (-)

The speakers and the subwoofer output terminals are located on the 10-pin MATE-N-LOK connector marked "SUB R-R R-L F-R F-L"



CAUTION: AQUASOUL PRO DOES NOT COME WITH SPEAKERS AND ASSOCIATED WIRING. THE INTERCONNECTION BETWEEN THE AUDIO SYSTEM AND THE SPEAKERS MUST BE "CLASS 2 WIRING" AND BE DONE BY QUALIFIED PERSONNEL.



To connect your own speaker cable or to connect the optional adaptor, insert the 10-pin connector into the appropriate connector. Route the wires through the molded strain relief channel as illustrated.

OPTIONAL ACCESSORIES - AQUASOUL PRO

CONNECTIONS

PAIRING WITH A BLUETOOTH ENABLED DEVICE

Aquasoul Pro can play music from any device equipped with Bluetooth wireless technologies, however, you must pair your mobile device to the audio receiver in order to do so.

The system is ready to pair when it is not already connected to another device. To pair your device, make sure that you are close enough to the Aquasoul Pro, that it is turned on and that it is set in Bluetooth mode.

FOLLOW THESE STEPS TO PAIR YOUR DEVICE

1. Open the Bluetooth settings on your device. The location of the settings will depend on the device you are using.
2. Make sure Bluetooth is on.



3. Select "in.stream 2" in the list of discoverable Bluetooth devices detected nearby.
4. When prompted, enter 5555 as the PIN Code.



NOTE: In basic configuration (not connected to a keypad or controller), Aquasoul Pro is set in Bluetooth mode. Otherwise, please refer to your specific keypad operating manual for details on the Aquasoul Pro functions.

5. Once the pairing is done, select in.stream 2. When "connected" is displayed, Aquasoul Pro will be ready to start playing the selected audio.



Note: If the device moves out of range and loses connection, it should reconnect automatically as soon as it is close enough. This should happen without having to go through the menu again.

Aquasoul Pro will keep up to 8 devices in its memory. If one of the last three connected devices is in range and has its Bluetooth turned on, it will automatically connect to Aquasoul Pro.

If multiple devices are within range and have already been paired with Aquasoul Pro, priority will be given to the device that was first detected in the Aquasoul Pro memory.

OPTIONAL ACCESSORIES - MY MUSIC

MY MUSIC

NO EXTERNAL CONTROL UNIT



1. Listening to music via Bluetooth

1.1 Pairing Bluetooth devices

1. Turn on the Bluetooth device
2. Select ProwBT/MyMusic from the available devices and pair it (no password needed). Only one Bluetooth device can be paired with the Bluetooth Media Player at a time.

1.2 Listening to music via Bluetooth device

1. The Bluetooth mode is activated as soon as it is paired with a Bluetooth device.
2. Play music on the device and the Bluetooth Media Player will provide the sounds.
3. Press the PLAY/PAUSE buttons to play or pause the music.
4. Press the FAST REWIND/FORWARD buttons to play the previous/next track.
5. The songs/tracks and volume can be set directly on your Bluetooth device or with a remote control.

We would like to inform you that the new 2.0 speakers require a PIN for connection. The PIN number is: 2288

OPTIONAL ACCESSORIES - IN.CLEAR

IN.CLEAR

Bromine based water sanitization system for hot tub



START UP PROCEDURE

(Instruction video: www.geckoal.com/inclear)

1. Fill the hot tub with water.
2. Begin heating the water to your desired temperature.
3. Balance your water parameters (see info in your user guide regarding water chemistry for hot tub: total hardness, alkalinity, pH).
4. Start main pump and add BromiCharge™ slowly into the warm water, 0.54 kg for every 378 liters (1.2 lbs per every 100 gallons) of water.
5. Turn on the in.clear system by pressing and holding the on/off button (⏻) for 2 seconds, until your display lights up. Refer to your user manual for information on achieving the proper BromiCharge™ quantity.
6. Now you're ready to calibrate your in.clear settings. There are 2 settings, Maintenance and Boost.
7. Maintenance: Your Maintenance value was set at the factory. It should read "5" to start. Using your hot tub while you're establishing the residual will slow the process. Be patient. Check your bromine level each day with a test kit.

Your goal is a residual bromine bank of 3 – 5 ppm. If the bromine content of your water is less than 3 ppm, press and hold the Maintenance key (⏻) for 2 seconds and increase the Maintenance setting by 1 or 2 increments with the up arrow (⬆️). Repeat daily until your bromine level stabilizes at 3 – 5 ppm.

IMPORTANT FOR THE STAND ALONE VERSION: Make sure your hot tub is filtering the water at least 8 hours per day. The in.clear only creates bromine when the filter pump is running.

8. Boost: Every time you use the hot tub, press Boost (⚡). Boost runs a clean-up cycle that returns your residual bromine to the proper level. You should run Boost every time you use the hot tub. Press Boost key (⚡). Set the Boost level by using the up and down arrow (⬆️⬆️) to select the number of bathers that use the hot tub (i.e., 2 users = 2, and so on). With the proper Maintenance level setting, and consistent use of the Boost mode, your hot tub will be ideally maintained.

Refer to our web site www.geckoalliance.com/inclear for detailed information about the operation of the in.clear.

INTRODUCTION

HOW THE IN.CLEAR WORKS

When sodium bromide (such as BromiCharge) is added to the water, it separates into sodium ions and bromide ions. As the water passes through the in.clear bromine generator, a low-voltage source supplies a current that electrolytically reduces the bromine ions into bromine. The bromine destroys bacteria and algae, and then releases bromide ions back into the water for continuous recycling until the hot tub is emptied. It is important to note that the amount of bromine needed will vary in direct proportion to the number of bathers in the hot tub (bather load).

VERSIONS

There are two versions of the in.clear module: a stand alone version that uses the in.k200 keypad directly, and the linked version, which communicates with the hot tub pack for more control and precision.



EFFECTS OF BROMINE

- Bromine destroys waterborne bacteria.
- Bromine destroys algae in water (e.g. Black, Green, Mustard).
- Bromine swiftly eliminates the presence of organic matter left behind by hot tub users (e.g. oil, sweat, dead skin cells).
- Because bromine doesn't contain calcium, it can be used to sanitize hard water without increasing the calcium hardness.

BROMINE IN A HOT TUB

Bacteria require a certain period of time before forming into micro colonies and becoming attached to a surface. Rapid elimination of bacteria is a key element in the proper maintenance of the hot tub water. The in.clear achieves this while oxidizing odors, reducing eye and skin irritation. The in.clear enhances the clarity and quality of hot tub water. For bathers this translates into a more enjoyable warm water therapy experience.

OPTIONAL ACCESSORIES - IN.CLEAR

BEFORE STARTING

(see video: www.geckcoal.com/inclear)

1. DRAIN AND CLEAN THE HOT TUB

It's important to completely drain and clean the hot tub to remove all residues accumulated on the surface and inside or around the jet area. After draining the hot tub, use hot tub cleaning products only. Household cleaners contain additives such as phosphates which may affect the bromine production. When the hot tub is clean, rinse it off thoroughly with a garden hose.

 It's extremely important to clean your filter cartridge with a filter soaking solution or replace your filter cartridges.

 It is important that the hot tub is well cleaned and rinsed prior to the startup of the new system. Some biofilms may have formed in the hot tub that could prevent the system from functioning properly. We strongly recommend the use of a flushing product such as Hot tub System Flush, Swirl Away or National Chemistry Hot tub Purge to clean the plumbing even if the hot tub is brand new.

2. REFILL THE HOT TUB WITH FRESH WATER

After the in.clear unit has been installed, check the TDS (Total Dissolved Solids) of the water you'll use to refill the hot tub. Verifying the TDS range can be done by your local hot tub dealer. The TDS range should be within 50 and 400 PPM. When you're certain the water is within the proper TDS range, refill your hot tub.

 If your TDS is higher than 500 PPM, ask your hot tub dealer for additional information to help reduce initial TDS.

 DO NOT use water from a "Salt Water Softener" system. Make sure there is adequate flow and that no airlocks are trapped in the unit's plumbing. If airlocks are formed, start the pump and slowly loosen one of the union nuts to release the air trapped in the plumbing. Tighten the nut again after you are done.

3. ADJUST WATER CHEMISTRY IN THE HOT TUB

Proper chemical maintenance of a hot tub is essential for the health of bathers. Maintaining the quality of the hot tub water within these specified values will enhance your enjoyment of the hot tub and prolong the life of the in.clear system.

For best results, adjust to the following water chemistry parameters. Check these parameters periodically.

 Calcium hardness (TH): between 150 and 200 PPM Total Alkalinity: between 100 and 120 PPM pH: between 7.2 and 7.8

 Water chemistry should be balanced before adding sodium bromide into the water. It's essential that the water chemistry parameters are within the proposed range to obtain optimal system performance.

 High Calcium Hardness may lead to faster calcification of the electrolytic plates.

4. ADD SODIUM BROMIDE (SUCH AS BROMICHARGE)

Water temperature between 32° and 38° C (90° and 100° F) helps dissolve sodium bromide and facilitates the adjustment of the maintenance level.

Start the pump to allow water to circulate and slowly add sodium bromide uniformly in the hot tub by simply pouring it from the container.

METRIC CALCULATION:

Add 0.143 kg of sodium bromide which has a guarantee of at least a 98% active ingredient, such as BromiCharge, per 100 L of water to attain 1 400 ppm TDS value (Total Dissolved Solids).

Example, if your hot tub holds 1200 L of water, add 1.72 kg of sodium bromide (12 X 0.143 kg).

IMPERIAL CALCULATION:

Add sodium bromide which has a guarantee of at least a 98% active ingredient, such as BromiCharge per 100 US gallons of water.

Example, if your hot tub holds 300 US gallons of water, add 3.6 lbs of sodium bromide (3 X 1.2 lb).

Note: Your hot tub manufacturer can tell you how much water your hot tub holds (in liters or gallons).

SODIUM BROMIDE INFORMATION

In Canada, the in.clear must only be used with sodium bromide (such as BromiCharge) scheduled or registered under the Pest Control Product Act. In the USA, the sodium bromide (such as BromiCharge) must be registered under the EPA.

Your warranty will be void if a product other than sodium bromide is used as a substitute.

 Do not inhale the product or get into your eyes! First Aid instructions should appear on the label of the registered sodium bromide container.

 Do not use any other sanitation chemicals (including shock) other than sodium bromide in the hot tub.

 When adding fresh water to the hot tub, start a Boost to help build a residual bromine bank.

OPTIONAL ACCESSORIES - IN.CLEAR

IN.CLEAR OPERATING MODES

This manual details the functions of the in.clear with the default keypad (in.k200). If your hot tub pack uses a compatible keypad (ex. in.k800) please see its manual for more specific information.

MAINTENANCE MODE

Maintenance Mode keeps the bromine bank levels at a stable and acceptable range when the hot tub is not being used. Maintenance mode is the “everyday” mode and is automatically ON when the system is activated. Maintenance level adjustment changes the rate at which bromine will be released into the hot tub water.

Finding and setting the right maintenance level will keep the residual bromine level between 3 and 5 PPM (the recommended range) when the hot tub is not being used or is left unused for an extended period of time. Once the proper maintenance level is determined, keep the same setting unless the hot tub conditions change (change in water temperature, hot tub location etc).

Finding the right bromine generation level is a crucial step for the in.clear system to be stable and effective (see Set Maintenance Mode).

⚠ With the stand alone version, the hot tub filtration should be set to a minimum of 8 hours per day. To check the minimum filtration time for your hot tub, see the Program Key section.

⚠ With the linked version, it is not necessary to set the filtration duration, as communication between the pack and in.clear allows the system to stop and start the associated pump at the best times.

It is important to note that the in.clear system can ONLY generate bromine when the water is circulating. If you are having problems maintaining a stable level of bromine, or determining the proper maintenance level for your hot tub, you may have to increase the daily filtering time. Longer filtration produces a more steady level of bromine.

BOOST MODE

The Boost Mode should be activated every time you use your hot tub. Boost mode increases the bromine generation rate to attack pollutants in the water and helps rebuild the necessary residual bromine in the water after each use of the hot tub. Pollutants are introduced to the water by the bathers, causing the bromine levels to decrease. Activating the boost mode when you enter the hot tub will prevent inadequate bromine levels and will restore your bromine to the proper residual level.

Finding the right boost level is another crucial step for the in.clear system to be stable and effective.

⚠ If water quality is not good after use, only the boost level should be adjusted, not the maintenance level.

KEYPAD FUNCTIONS

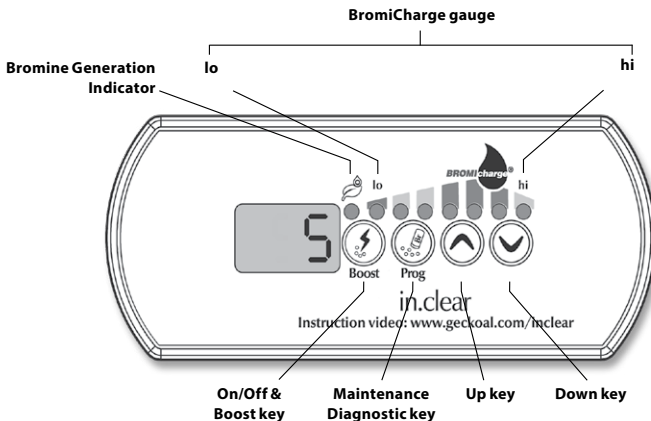

OPTIONAL ACCESSORIES - IN.CLEAR

KEYPAD FUNCTIONS

BOOST KEY



The first press of the Boost key turns the in.clear ON and puts the in.clear into maintenance mode. ON appears on the keypad display.

Press the Boost key once while in maintenance mode to start a boost, or to adjust boost settings.*

The Bromine Generation Indicator (LED), located above the Boost key, lights up when the cell is producing bromine and is off when no bromine is being produced.

Press and hold the Boost key for 2 seconds to turn the in.clear off. OFF will appear on the

keypad display. Do not turn the in.clear off unless required for maintenance, or if advised by a technician or a Gecko representative. Turning the in.clear off will cancel the boost.

Note: With the standalone version the Bromine Generation indicator will blink if the in.clear system cannot generate bromine due to low or no water flow.

* In older versions, pressing the Boost key during a boost cycle will cancel the remainder of that boost cycle and return the in.clear system to maintenance mode.

PROGRAM KEY



Press and hold the Program key for 2 seconds to change the maintenance mode level.

Once in maintenance mode adjustment, press the Program key again to view the suggested minimum filtration time * (stand alone version only). Press the Program key once more for Diagnostic mode.

* Not displayed in older versions.

+/- KEYS



Use the Up and Down keys to adjust the maintenance and boost levels while in the appropriate mode.

DIAGNOSTIC MODE

Diagnostic mode can be used to periodically adjust the sodium bromide level or to check sodium bromide keypad warnings and errors.

The BromiCharge Gauge will indicate the level of sodium bromide in the hot tub water. As you add sodium bromide to the hot tub an animation will indicate rising levels*. If the levels go down (when adding fresh water, for example) the animation will indicate diminishing levels.

Press the Prog key to exit diagnostic mode or the system will automatically exit after 15 minutes.

*In older versions a number will be displayed instead of an animation to indicate the level. The target number is 12.

BROMICHARGE GAUGE (LEDS)

In diagnostic mode, the BromiCharge gauge (LEDs) indicates the approximate sodium bromide level of your hot tub water. Do not add sodium bromide if the indicator is in the green zone.

When adding sodium bromide, the gauge indicator will gradually shift to the right. When adding clean water to the hot tub the indicator will shift to the left. In order to achieve the proper level, start pumps and add 227g (.5 lb) at a time and always allow 5 minutes for the gauge to react before adding more sodium bromide.

The green zone in the center area of the gauge should be targeted for optimal performance.



Water must be circulating through the in.clear cell in order for the diagnostic mode to work. If no water is circulating through the in.clear unit, a FLO message will appear on the keypad display. Make sure the pump is circulating water through the in.clear.



Be aware that the gauge will move according to sodium bromide level.



Make sure your water temperature is at least 32°C (90°F).

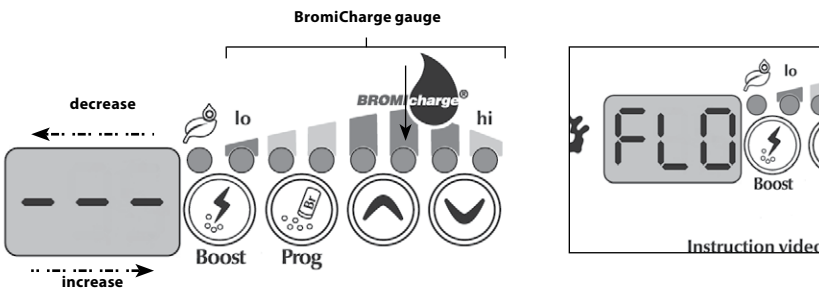

START UP PROCEDURE





Set the maintenance level

Determining the proper maintenance level for your hot tub is an extremely important step. DO NOT use your hot tub during this step as it will slow the process. Be patient. Make sure you follow steps 1 through 4 of the Before Starting section before performing the following steps.

1. Power up your hot tub and activate the system by pressing the Boost key.
2. Make sure your maintenance level is set to 15. To adjust the level, press and hold the Program key for 2 seconds, then use the Up and Down keys to adjust the maintenance level. The bromine generation rate ranges from 1 to 50, where 1 corresponds to the system's minimum generating rate and 50 corresponds to the maximum generation rate allowed by the system.

OPTIONAL: Set the boost to level 2 to help build up the bromine bank faster and speed up the startup process.

3. Use a test kit to check the bromine level every 12-24 hours*. The bromine level should be between 3-5 PPM. If the bromine level is within that range for 3 consecutive days, you are ready to use your hot tub. If the bromine level is above 5 PPM, decrease the maintenance level. If the bromine level is below 3 PPM, increase the maintenance level.
4. Repeat step 3 until bromine is stable between 3 and 5 PPM for 3 consecutive days.

-  Do NOT increase/decrease maintenance level in steps greater than 2.
-  Setting the maintenance level to a value that's too high can cause damage to your equipment.
-  Check bromine level and always test water before entering the hot tub.
-  If the bromine level is higher than 5 PPM, lower the maintenance level and turn off the system until the bromine level is back below 5 PPM Then, restart the system and continue monitoring the bromine level.

To lower the bromine level, expose your hot tub water to the sun and activate all pumps for a few cycles.

*** Testing bromine levels with FAS-DPD drop count method is more accurate than using test strips. Bromine FAS-DPD is available at www.geckodepot.com under number 0699-300008.**

DETERMINE THE BOOST LEVEL



Every time you use your hot tub, activate the boost mode. As a rule of thumb, the boost level corresponds to the number of bathers using the hot tub. For example, activate the boost level to 2 if two bathers are entering the hot tub.

1. With the system in maintenance mode, press the Boost key to activate the Boost mode.
2. The keypad display will show a numeric value that corresponds to the selected level. There are 8 possible levels available with the boost mode. Set the boost level by using the up and down arrow to select the number of bathers that use the hot tub.
3. Confirm the selection by pressing the Boost key again or wait 5 seconds for the system to save the desired level and activate the Boost cycle.

Note: The in.clear keeps the last used boost level in memory.

4. At the end of the boost period, verify that the bromine level has returned to the 3-5 PPM range. If the bromine level is too low or too high after the Boost period, the boost level should be adjusted the next time the hot tub is used. For example, if bromine level is higher than 5 PPM after a boost of 2, lower the boost level to 1 the next time. Repeat these steps until you are able to determine the ideal boost level for your usage.

Note: Boost levels depend on the number of bathers using the hot tub. We recommend you validate the Boost level after each use to determine the ideal boost level for all numbers of bathers.

-  Changing the water temperature setpoint of your hot tub, or using the economy mode, could require a change in the maintenance level of your in.clear. Lower water temperatures may require a lower maintenance level than higher temperature setpoints. Please check your bromine level when changing your temperature setpoint or using the economy mode of your hot tub.
-  Never adjust the maintenance level of your in.clear without allowing at least 24 hours following the end of the boost period. Boost cycles allow the residual bromine level to stabilize. Bromine levels outside the 3-5 PPM range may result from pollutants following usage.

Linked version only: If the pack connected to the in.clear detects hot tub use (pumps, blower, or lights active) for 5 minutes without a boost, it will automatically start a boost at the last used level. This is a security feature only, and should not be used to replace the boost setting. Incorrect boost settings for the bather load could damage hot tub parts and/or be hazardous to bathers.

TROUBLESHOOTING



LOW SODIUM BROMIDE ERROR

Low Sodium Bromide Error (Err) occurs when the sodium bromide level is too low. The lo LED indicator will blink when the error is present. The in.clear system will not generate bromine until the Low Sodium Bromide Error (Err) is cleared.

To clear the Low Sodium Bromide error (Err), add sodium bromide to the hot tub water. Let water circulate for 5 minutes. Activate diagnostic mode and add more sodium bromide until gauge is back in the green zone. Exit diagnostic mode.

LOW SODIUM BROMIDE WARNING

Low Sodium Bromide Warning (Lo) indicates the need to add sodium bromide to the hot tub water.

In diagnostic mode, add sodium bromide to the water until the gauge reaches the green zone to clear a Low Sodium Bromide Warning (Lo).



If after adding sodium bromide the Low Sodium Bromide Warning (Lo) or Low Sodium Bromide Error (Err) still occurs it could be the result of:

- calcification of the electrolytic plates;
- airlocks trapped in the in.clear unit or insufficient flow;
- internal pressure switch problem.



BLINKING "AC"

A blinking "AC" message displayed on the keypad indicates that there is a problem with the power input. The most common reason is that the in.clear unit is supplied with 120 V instead of 240 V.

Please make sure power cord is connected properly to a 240 V source.

STANDALONE VERSION ONLY: BROMINE GENERATION INDICATOR BLINKING

A blinking Bromine Generation LED means that the system is unable to generate bromine because no water flow is detected by the in.clear system. This situation is normal if the pump is not running and no water is flowing through the in.clear. However, if water is circulating through the in.clear unit, and the Bromine Generation LED is still blinking, make sure that the in.clear is installed on the pressure side of the pump and that water is properly flowing through the in.clear unit.

BROMINE GENERATION INDICATOR IS OFF

The Bromine Generation LED indicator is OFF when there is no need for bromine generation. This situation is normal, especially with low maintenance level of bromine generation set on the keypad.

OPTIONAL ACCESSORIES - IN.CLEAR

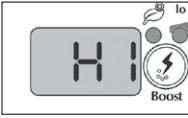

HIGH SODIUM BROMIDE WARNING

High Sodium Bromide Warning (Hi) occurs when too much sodium bromide is present in the water or there is a high TDS level (water hardness, alkalinity, organic compounds, etc).

To clear a High Sodium Bromide Warning, readjust the sodium bromide content of your water in diagnostic mode, into the green zone by draining some water from your hot tub and adding fresh water.



IN.CLEAR IS TURNED OFF

The OFF message indicates that the in.clear is turned off.

Press the Boost key to reactivate the in.clear.



FLO ERROR (OUT OF DIAGNOSTIC MODE)

With the linked version the FLO error appears when the in.clear's pressostat is open for longer than 3 minutes and the pump associated with it was activated by the hot tub pack.

Verify that the in.clear unit was installed on the right pump (must be installed on the circulation pump if present).

Check that the in.clear is installed on the pressure side of the pump and that water is flowing through the in.clear unit.



COMMUNICATION ERROR

The Co error indicates that a linked version of the in.clear is being used, but a pack cannot be detected. Ensure that you are using a compatible pack with appropriate software, and that all connections are secure. If this does not clear the message, contact your dealer for help.

TROUBLESHOOTING

LOW OR NO BROMINE READING

Make sure the maintenance level is properly set according to the procedure described in the section Set Maintenance Level. Make sure there is no error or warning message on the display, the cell is activated and that water is circulating properly through the cell.

Make sure water chemistry is balanced. Refer to the section Adjust Water Chemistry in the Hot tub for more details.

Test your hot tub water for phosphate to make sure there is no contamination. Phosphates should never exceed 100 PPB. Phosphates can be introduced to your hot tub water by household cleaners, soaps and lotions.

Change your filter or clean it with a filter cleaner and rinse thoroughly with cold water.

Make sure the in.clear cell is not damaged and that no calcium or lime deposits appear on the cell plates. Clean your cell regularly (at least once a year).

LONG RECOVERY TIME AFTER USAGE

Activate Boost Mode at the appropriate level every time you use your hot tub. Refer to the section Determine the Boost Level.

Heavy bather loads will require longer boost periods. If bromine level is below 3 PPM following a boost period, re-activate Boost Mode to bring the bromine bank within 3-5 PPM.

The bromine bank should always be regenerated following a boost period. If a high boost level does not regenerate the bromine bank properly, increase the daily filtration time.

If bromine production is still inadequate after following all of the instructions above, biofilm deposits could be causing the lack of bromine generation. Flushing products such as Sea Klear Hot tub System Flush, Swirl Away or National Chemistry Hot tub Purge have shown to be effective for biofilm removal.

OPTIONAL ACCESSORIES - IN.CLEAR (IN SMART TOUCH)

IN.CLEAR OPERATING MODES

IF YOU ARE A USING A SMART TOUCH, PLEASE REFER TO THE USER INTERFACE SECTION TO GET THE INSTRUCTIONS ABOUT THE SANITIZATION MODE.



MAINTENANCE MODE

Maintenance Mode keeps the bromine bank levels at a stable and acceptable range when the hot tub is not being used. Maintenance mode is the “everyday” mode and is automatically ON when the system is activated. Maintenance level adjustment changes the rate at which bromine will be released into the hot tub water.

Finding and setting the right maintenance level will keep the residual bromine level between 3 and 5 PPM (the recommended range) when the hot tub is not being used or is left unused for an extended period of time. Once the proper maintenance level is determined, keep the same setting unless the hot tub conditions change (change in water temperature, hot tub location, etc).

Finding the right bromine generation level is a crucial step for the in.clear system to be stable and effective (see Set Maintenance Mode).

It is important to note that the in.clear system can ONLY generate bromine when the water is circulating. If you are having problems maintaining a stable level of bromine, or determining the proper maintenance level for your hot tub, you may have to increase the daily filtering time. Longer filtration produces a more steady level of bromine.

BOOST MODE

The Boost Mode should be activated every time you use your hot tub. Boost mode increases the bromine generation rate to attack pollutants in the water and helps rebuild the necessary residual bromine in the water after each use of the hot tub. Pollutants are introduced to the water by the bathers, causing the bromine levels to decrease. Activating the boost mode when you enter the hot tub will prevent inadequate bromine levels and will restore your bromine to the proper residual level.

Finding the right boost level is another crucial step for the in.clear system to be stable and effective.



If water quality is not good after use, only the boost level should be adjusted, not the maintenance level.

OPTIONAL ACCESSORIES - IN.CLEAR (IN SMART TOUCH)

START UP PROCEDURE

IF YOU ARE A USING A SMART TOUCH, PLEASE REFER TO THE USER INTERFACE SECTION TO GET THE INSTRUCTIONS ABOUT THE SANITIZATION MODE.

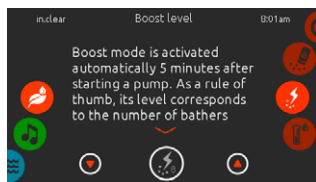
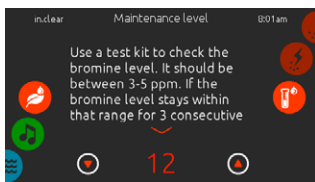

SET THE MAINTENANCE LEVEL

Determining the proper maintenance level for your hot tub is an extremely important step. DO NOT use your hot tub during this step as it will slow the process. Be patient. Make sure you follow steps 1 through 4 of the Before Starting section before performing the following steps.

1. Power up your hot tub and activate the system by pressing the Boost key.
2. Make sure your maintenance level is set to 15. To adjust the level, press and hold the Program key for 2 seconds, then use the Up and Down keys to adjust the maintenance level. The bromine generation rate ranges from 1 to 50, where 1 corresponds to the system's minimum generating rate and 50 corresponds to the maximum generation rate allowed by the system.
OPTIONAL: Set the boost to level 2 to help build up the bromine bank faster and speed up the startup process.
3. Use a test kit to check the bromine level every 12-24 hours*. The bromine level should be between 3-5 PPM. If the bromine level is within that range for 3 consecutive days, you are ready to use your hot tub. If the bromine level is above 5 PPM, decrease the maintenance level. If the bromine level is below 3 PPM, increase the maintenance level.
4. Repeat step 3 until bromine is stable between 3 and 5 PPM for 3 consecutive days.

⚠ Do NOT increase/decrease maintenance level in steps greater than 2.

⚠ Setting the maintenance level to a value that's too high can cause damage to your equipment.

⚠ Check bromine level and always test water before entering the hot tub.

⚠ If the bromine level is higher than 5 PPM, lower the maintenance level and turn off the system until the bromine level is back below 5 PPM Then, restart the system and continue monitoring the bromine level.

To lower the bromine level, expose your hot tub water to the sun and activate all pumps for a few cycles.

***Testing bromine levels with FAS-DPD drop count method is more accurate than using test strips. Bromine FAS-DPD is available at www.geckodepot.com under number 0699-300008.**

DETERMINE THE BOOST LEVEL

Every time you use your hot tub, activate the boost mode. As a rule of thumb, the boost level corresponds to the number of bathers using the hot tub. For example, activate the boost level to 2 if two bathers are entering the hot tub.

1. With the system in maintenance mode, press the Boost key to activate the Boost mode.
2. The keypad display will show a numeric value that corresponds to the selected level. There are 8 possible levels available with the boost mode. Set the boost level by using the up and down arrow to select the number of bathers that use the hot tub.
3. Confirm the selection by pressing the Boost key again or wait 5 seconds for the system to save the desired level and activate the Boost cycle.
Note: The in.clear keeps the last used boost level in memory.
4. At the end of the boost period, verify that the bromine level has returned to the 3-5 PPM range. If the bromine level is too low or too high after the Boost period, the boost level should be adjusted the next time the hot tub is used. For example, if bromine level is higher than 5 PPM after a boost of 2, lower the boost level to 1 the next time. Repeat these steps until you are able to determine the ideal boost level for your usage.
Note: Boost levels depend on the number of bathers using the hot tub. We recommend you validate the Boost level after each use to determine the ideal boost level for all numbers of bathers.

⚠ Changing the water temperature setpoint of your hot tub, or using the economy mode, could require a change in the maintenance level of your in.clear. Lower water temperatures may require a lower maintenance level than higher temperature setpoints. Please check your bromine level when changing your temperature setpoint or using the economy mode of your hot tub.

⚠ Never adjust the maintenance level of your in.clear without allowing at least 24 hours following the end of the boost period. Boost cycles allow the residual bromine level to stabilize. Bromine levels outside the 3-5 PPM range may result from pollutants following usage.

Linked version only: If the pack connected to the in.clear detects hot tub use (pumps, blower, or lights active) for 5 minutes without a boost, it will automatically start a boost at the last used level. This is a security feature only, and should not be used to replace the boost setting. Incorrect boost settings for the bather load could damage hot tub parts and/or be hazardous to bathers.

OPTIONAL ACCESSORIES - IN.CLEAR (IN SMART TOUCH)

TROUBLESHOOTING

ERROR MESSAGES WILL APPEAR ONLY WHEN IN SANITIZATION MODE.



Error! Bromicharge level too low
Add Bromicharge to spa water

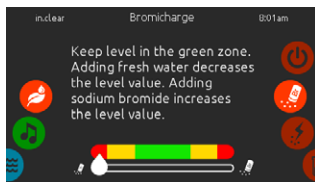

in.clear: Problem with power input
Connect power to 240VAC source

BROMICHARGE LEVEL TOO LOW

Low Sodium Bromide Error occurs when the sodium bromide level is too low. The in.clear system will not generate bromine until the Low Sodium Bromide Error is cleared.

To clear the Low Sodium Bromide error, add sodium bromide to the hot tub water. Let water circulate for 5 minutes. Activate diagnostic mode and add more sodium bromide until gauge is back in the green zone. Exit diagnostic mode.

LOW SODIUM BROMIDE WARNING

Low Sodium Bromide Warning indicates the need to add sodium bromide to the hot tub water.

In diagnostic mode, add sodium bromide to the water until the gauge reaches the green zone to clear a Low Sodium Bromide Warning.



If after adding sodium bromide the Low Sodium Bromide Warning or Low Sodium Bromide Error still occurs it could be the result of:

- calcification of the electrolytic plates;
- airlocks trapped in the in.clear unit or insufficient flow;
- internal pressure switch problem.

INPUT AC

A input AC message displayed on the keypad indicates that there is a problem with the power input. The most common reason is that the in.clear unit is supplied with 120 V instead of 240 V.

Please make sure power cord is connected properly to a 240 V source.

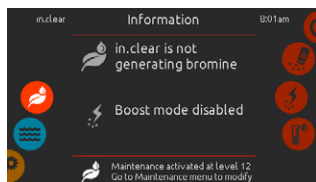

Bromicharge level too high
Add Fresh water to the spa



IN.CLEAR IS NOT GENERATING BROMINE

Smart Touch will display this message when your hot tub system has stopped generating sodium bromine. This is normal, especially with low maintenance level of BromiCharge™ set on your keypad.

HIGH SODIUM BROMIDE WARNING

High Sodium Bromide Warning occurs when too much sodium bromide is present in the water or there is a high TDS level (water hardness, alkalinity, organic compounds, etc).

To clear a High Sodium Bromide Warning, readjust the sodium bromide content of your water in diagnostic mode, into the green zone by draining some water from your hot tub and adding fresh water.

IN.CLEAR IS OFF

This message indicates that the in.clear is turned off.

Press the Boost key to reactivate the in.clear.

OPTIONAL ACCESSORIES - IN.CLEAR (IN SMART TOUCH)

TROUBLESHOOTING



ERROR in.clear!
No flow condition

NO FLOW CONDITION (OUT OF DIAGNOSTIC MODE)

With the linked version, this message appears when the in.clear's pressostat is open for longer than 3 minutes and the pump associated with it was activated by the hot tub pack.

Verify that the in.clear unit was installed on the right pump (must be installed on the circulation pump if present).

Check that the in.clear is installed on the pressure side of the pump and that water is flowing through the in.clear unit.



Lost communication with in.clear
Verify cable connections

COMMUNICATION ERROR

The lost communication error indicates that a linked version of the in.clear is being used, but a pack cannot be detected. Ensure that you are using a compatible pack with appropriate software, and that all connections are secure. If this does not clear the message, contact your dealer for help.

LOW OR NO BROMINE READING

Make sure the maintenance level is properly set according to the procedure described in the section Set Maintenance Level. Make sure there is no error or warning message on the display, the cell is activated and that water is circulating properly through the cell.

Make sure water chemistry is balanced. Refer to the section Adjust Water Chemistry in the Hot tub for more details.

Test your hot tub water for phosphate to make sure there is no contamination. Phosphates should never exceed 100 PPB. Phosphates can be introduced to your hot tub water by household cleaners, soaps and lotions.

Change your filter or clean it with a filter cleaner and rinse thoroughly with cold water.

Make sure the in.clear cell is not damaged and that no calcium or lime deposits appear on the cell plates. Clean your cell regularly (at least once a year).

LONG RECOVERY TIME AFTER USAGE

Activate Boost Mode at the appropriate level every time you use your hot tub. Refer to the section Determine the Boost Level.

Heavy bather loads will require longer boost periods. If bromine level is below 3 PPM following a boost period, re-activate Boost Mode to bring the bromine bank within 3-5 PPM.

The bromine bank should always be regenerated following a boost period. If a high boost level does not regenerate the bromine bank properly, increase the daily filtration time.

If bromine production is still inadequate after following all of the instructions above, biofilm deposits could be causing the lack of bromine generation. Flushing products such as Sea Klear Hot tub System Flush, Swirl Away or National Chemistry Hot tub Purge have shown to be effective for biofilm removal.

OPTIONAL ACCESSORIES - IN.CLEAR

FREQUENTLY ASKED QUESTIONS

Q: WHY IS MY HOT TUB WATER CLOUDY/OILY?

A: If your hot tub becomes cloudy or oily due to bather load perform an additional Boost and wait for 24 hours to see if conditions return to normal. If the problem persists consult a hot tub/pool dealer to have your water balanced properly.

Q: DOES THE SODIUM BROMIDE EVAPORATE?

A: No. Sodium bromide is only lost through splash out, leaks or when draining your hot tub.

Q: WHAT SHOULD I USE TO CLEAN MY HOT TUB?

A: Always use a non-sudsing cleaner found at your hot tub store.

Q: WHEN MY IN.CLEAR BROMINE GENERATOR IS OFF DOES THE SODIUM BROMIDE CONTINUE SANITIZING MY HOT TUB?

A: No, the in.clear system does not sanitize if inactive. If there is a residual bank of bromine, bromine continues to sanitize the hot tub water. The in.clear may be off at certain times and the hot tub will still be fine and clean.

The sodium bromide is converted to bromine as it passes through the electrodes of the in.clear system and the pump associated with the in.clear is running.

GLOSSARY

TDS

Total Dissolved Solids (TDS) is an expression for the combined content of all inorganic and organic substances contained in a liquid which are present in a molecular, ionized or micro-granular (colloidal sol) suspended form.

pH

pH (potential hydrogen) is a measure of the acidity or basicity of a solution.

PPM

"Parts-per million" notation is used to denote relative proportions or a comparative ratio in a given measured quantity.

The expression "1 PPM" means a given property exists at a relative proportion of one part per million parts examined, as would occur if a water-borne pollutant was present at a concentration of one-millionth of a gram per gram of sample solution.

TOTAL ALKALINITY (TA)

Total Alkalinity or TA is a measure of the ability of a solution (such as water) to neutralize acids to the equivalence point of carbonate or bicarbonate.

BATHER LOAD

This term is used to describe the number of bathers using a hot tub, combined with the length and frequency of its usage. The higher the bath usage, the greater quantity of chemicals needs to be added to maintain the same hot tub water quality.

CALCIUM HARDNESS (CH)

Calcium Hardness describes the concentration of calcium in your hot tub water.

TOTAL HARDNESS (TH)

Total Hardness describes the concentration of calcium and magnesium in your hot tub water.

ORGANIC MATTER

Substances left behind by hot tub users such as oil, sweat and dead skin cells that serve as "food" for bacteria.

CELL CLEANING

In.clear includes a self-cleaning feature to prevent scale deposits on the graphite electrodes of the in.clear system. However, deposits may still form due to hard water. If that happens the cell should be cleaned in an acidic solution.

All power must be disconnected before any service procedure is performed.

Disconnect the communication cable and power cable of the in.clear unit.

TO CLEAN THE IN.CLEAR CELL, FOLLOW THESE STEPS:

- To remove scales from the cell, we recommend using phosphoric acid (non-diluted) as the preferred cleaning product.
 - Close the hot tub flow shut off valves. Unscrew both unions from the unit and remove the cell from the hot tub equipment compartment.
 - Install the rubber washer and the plastic nut on the threaded end of the cell. Tighten plastic nut firmly.
 - Place the cell vertically with the cap end down into a plastic 19 L (5 U.S. gallon) bucket and carefully pour the acid solution into the cell until the 4 plates are covered (careful not to overflow). The acid solution will begin to produce bubbles to clean the electrodes.
- A foaming action will follow, which is caused by the scale deposits being dissolved from the plates. If rigorous foaming action does not begin, the cell does not need to be cleaned. Rinse and reinstall the cell.
- Allow the electrodes to remain in the solution until the foaming has stopped. However, DO NOT leave in acid for more than fifteen minutes. Excessive acid cleaning will damage the electrolytic cell.
 - Pour the acid solution back into the bucket and rinse the cell thoroughly with clean tap water. If deposits are still visible, repeat operation for fifteen minutes maximum (some acid may need to be added to the solution).
 - Remove the plastic nut and washer from the cell and keep them for future cell cleaning.
 - Rinse the in.clear with fresh water.
 - Re-install the in.clear unit into hot tub system plumbing, tighten all connections by hand. Open the hot tub flow shut off valves.
 - Reconnect the keypad and power cable.
 - Turn power on and start up the pump. Check the keypad to see that the bromine generation LED is on and resume normal operation.

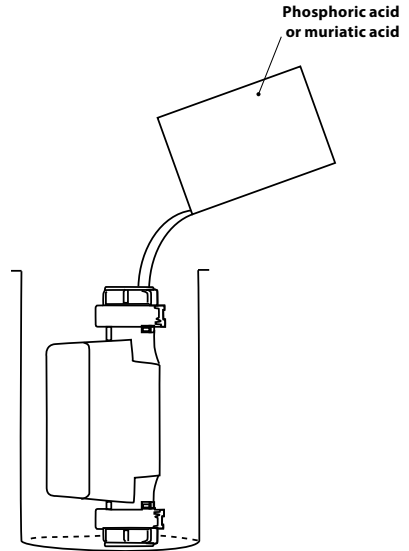

- ⚠ Refer to acid manufacturer's instructions.
- ⚠ Wear eye protection and rubber gloves during these operations. Splashing or spilling acid can cause severe personal injuries and/ or property damage.
- ⚠ Always work in a well-ventilated area.
- ⚠ Always add acid to the water; never add water to the acid.
- ⚠ Do not pour acid outside of the unit where the connectors are located.
- ⚠ Never use acetic acid to clean the cell, as this will cause permanent damage to cell components and void the warranty.

OPTIONAL ACCESSORIES - UV-C / OZONE

UV-C WATER TREATMENT

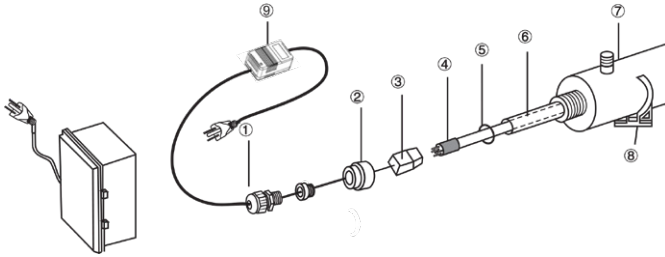

- 1- Water resistant lid
- 2- Aluminum nut
- 3- Lamp casing, wire outlet
- 4- Germicidal ultraviolet lamp
- 5- Rubber sealing ring
- 6- Quartz sleeve
- 7- Chamber
- 8- Pawl
- 9- Transformer

WARNING: THE GERMICIDAL ULTRAVIOLET RAYS ARE HARMFUL TO THE EYES, SKIN.

INTEGRATION:

1. Install the sterilization equipment at an easy to reach well lit place for effortless observation and maintenance.
2. Lock the clamp on the frame.
3. Insert the chamber with the help of the clamps.
4. Connect to the water supply.
5. Insert the quartz sleeve, sealing ring, lamp.

IMPORTANT: DO NOT TOUCH THE QUARTZ SLEEVE OR THE SIDES OF THE LAMP, ONLY HOLD IT BY THE TWO ENDS.

The ultraviolet lamp and the quartz can easily be damaged. Take care when removing or changing the lamp or the quartz sleeve.

- a. Take off the nut. (2).
- b. Carefully slide the quartz sleeve (6) from one end of the chamber to the other.
- c. Slide the sealing ring (5) onto the free end points of the quartz sleeve.
- d. Squeeze the aluminum nut on by hand (2).
- e. Slide the lamp (4) into the quartz sleeve.
- f. Connect the lamp to the casing.
- g. Screw the nut to the chamber, then screw on the water resistant lid (1) to the nut (2).
- h. Open the tap and check if the device is leaking. Repair as necessary.
- i. Plug the device into the electric supply. Use a socket equipped with a fault circuit interrupter (GFCI).

OZONE DISINFECTION

FILTRATION AND OZONE

In a system without circulation engines the low setting of the massage engine and the ozone generator will switch on during filtration. In a circulation type system ozone starts in a system with circulation engine.

The system is factory programmed for an evening filtration cycle since energy prices might be lower in the evening (assuming that the time of day is properly set). The filtration time and duration are programmable.

A second filtration cycle can be freely entered.

At the start of every filtration cycle the jets and engine start to clean the pipes and ensure proper water quality.

CHANGING THE LAMP AND SERVICING THE UV SYSTEM

Important: Do not touch the quartz sleeve or the sides of the lamp, only hold it by the ends.

1. Unplug the power plug.
2. Shut down and drain the water from the device to lessen pressure.
3. Take off the PVC lid (1) and unscrew the aluminum nut (2).
4. Carefully pull out the lamp (4) to approximately 5cm from the chamber (7).
5. Holding the lamp by the end carefully remove the lamp casing (3) on the free end.
6. Carefully take the lamp out of the chamber.
7. Carefully take off the sealing ring (5) from the end of the quartz sleeve.
8. Carefully take off the quartz sleeve.
9. To reinstall follow instructions 1 to 8 in reversed order

MAINTENANCE SUGGESTION:

In order for the sterilizer to work properly and with maximal efficiency the user should perform the following maintenance tasks.

1. Cleaning, changing the quartz sleeve:
 - a) The quartz sleeve is to be cleaned with a glass cleaner solution every 6-12 months.
 - b) The quartz sleeve is to be changed every 24 months.
2. Changing the UV lamp is recommended after 8-9000 operating hours (about 12 months of continuous operation).
3. To acquire interchangeable parts contact our headquarters or the local representatives of our company.

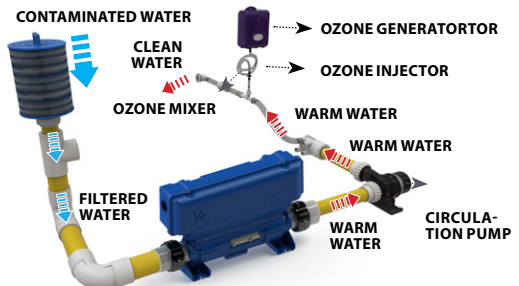

OPTIONAL ACCESSORIES - IN.GRID



in.grid

A FLEXIBLE WAY TO CONTROL EXTERNAL HEAT SOURCES FOR YOUR HOT TUB

Our new system interface lets you select, use and synchronize alternative heat sources to efficiently keep the hot tub water warm. Also acts as a hub to connect up to four single button switches and one 4 button auxiliary switch.

Connected to the Y series, in.grid gives you the advantages of using alternative heating sources. Connected to the CO port of your hot tub control system, in.grid will act as a dispatcher of external heating sources such as your heat pump or your central house heating system.

With in.grid, you can choose one of its four modes of operation that suits you the best, depending on your external heating system and your climate. Smart modes help you taking more advantage of your external heat source to optimize your savings.

INSTALLATION

The in.grid provides a connection to a normally open dry-contact relay on a spring-loaded female connector. The connector accepts bare wire connections. The cable must be passed through the already installed watertight grommet. Use wire gage between AWG 24 and AWG 16.

Use cable with round jacket suitable for the watertight grommet. Diameter should be between 0.090" and 0.250".

The dry contact is rated for low voltage of maximum 24V and 4A.



to heat pump or central hot water system

OPTIONAL ACCESSORIES - IN.GRID

INSTALLATION WITH EXTERNAL HEAT PUMP OR GAS HEATER

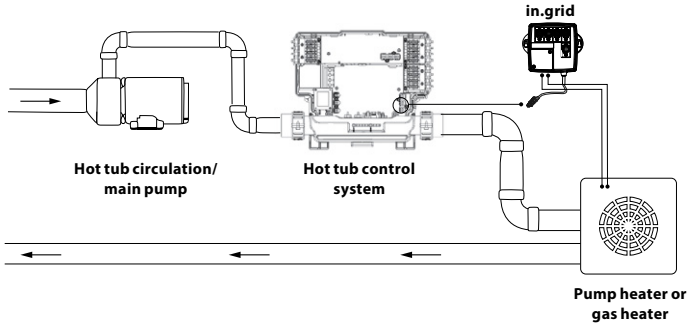

- ⚠ **IMPORTANT:** Your heat pump or gas heater must have all the flow and temperature limit protections.
- ⚠ Your heat pump or gas heater must be connected to your Y series hot tub control system. Make sure to always connect your external heating system in the same water pipe filter of your hot tub control system heater (as illustrated above).
- ⚠ The unit must be installed after your hot tub control system (as illustrated above).

- ⚠ You need to be sure your pump heater or gas heater is set to the maximum set point temperature. Your water temperature regulation will be controlled with your hot tub control system, by adjusting the set point on the hot tub keypad.
- ⚠ The in.grid dry contact should be hooked to the input for wire remote temperature control of the external heating system. Your voltage must be below 24 V.
- ⚠ If the in.grid controls are used with a gas heater, the remote temperature control input is usually called "fireman's switch".

INSTALLATION WITH A HEAT EXCHANGE UNIT

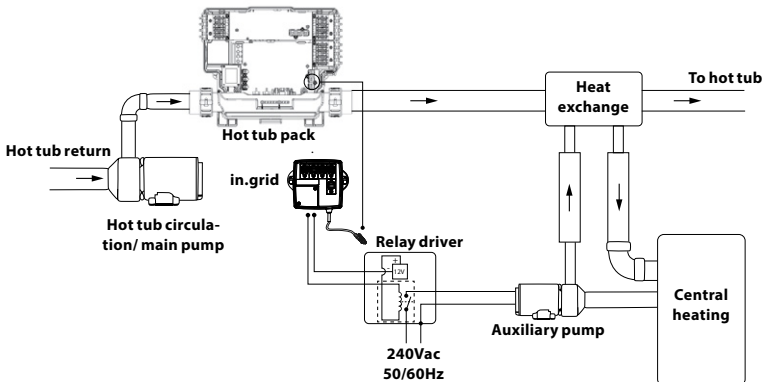

Please make sure your heat exchange does not have a flow restriction. The heater in your Y series hot tub control system needs a minimum of 20 GPM all the time.

Make sure to always connect your heat exchange unit in the same water pipe filter of your Y series hot tub control system heater.

The dry contact of the in.grid must only control a low voltage line and is used to power a low voltage relay coil. Use a relay driver to power up the auxiliary pump low voltage.

OPTIONAL ACCESSORIES - IN.GRID

Heat Mode Operations

You can choose between four different water regulation modes available. Your in.grid is automatically detected by the hot tub control system at power up. It will be ready to use with your preferred heat mode one minute following power up.

The relay contacts of the in.grid will be closed if the external heating system is activated. Otherwise, the relay contacts are open.

Your desired heat mode must be set by adding a jumper on one of the five (5) different positions.

***Note:** Your heat mode selection can be changed with the in.touch 2 app on your mobile device. On your app, any new selection will override the jumper setting of the in.grid. The in.touch 2 app will automatically detect the in.grid presence and will adapt its menu configuration as required.

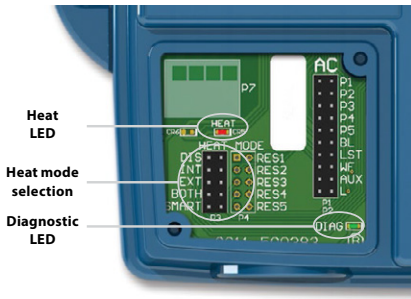

Five available heat modes are offered with in.grid:

1- DIS (DISABLED)

Use this mode if the hot tub configuration does not have any external heating system and only the single switch functionalities are used. This will avoid in.touch 2 application on a mobile device to display the Heat Mode Selection menu*. The hot tub controller will regulate the water temperature using the standard resistive heater. The single button switches will control the different hot tub accessories according to the AC jumper selections.

IMPORTANT: This mode can only be set with the heat mode jumpers.

2- INT (INTERNAL)

This mode provides an easy way to revert back to standard water regulation using the internal heater in case of problem with the external heating system.

** This mode can be set with your in.touch 2 app on a mobile device without the need to open the hot tub skirt to change the jumper setting on the in.grid. Thanks to your in.touch 2, it will be easier to set your preferred heating mode back once the external heating system is available.*

3- EXT (EXTERNAL)

Use this mode for a maximum energy saving purpose. The hot tub control system will only use your external heating system to regulate the water temperature. In normal operation, the internal heater will never be activated.

** This mode can be set with your in.touch 2 app on a mobile device without the need to open the hot tub skirt to change the jumper setting on the in.grid.*

Freeze Protection

Freeze protection has been added because EXT (EXTERNAL) mode does not allow the activation of the internal heater. In cold weather, if it becomes impossible to keep the water over freezing point, the help of the internal heater will then be needed. This is the only time the freeze protection will come in.

At any time, if the water temperature drops to 40°F (4.5°C), the resistive heater will give a boost to avoid freezing. The freeze protection will stay active until water temperature reaches the minimum allowed set point (usually 59°F / 15°C). Normal EXT mode will resume functioning thereafter.

4- BOTH (BOTH SYSTEMS ALL AT ONCE)

Use this mode for swim hot tubs or large hot tubs, which have bigger needs of energy to keep the water temperature at the desired set point.

The hot tub control system will always use the external heating system AND the internal heater simultaneously to regulate the water temperature; they are both activated or deactivated at the same time.

** This mode can be set with your in.touch 2 app on a mobile device without the need to open the hot tub skirt to change the jumper setting on the in.grid.*

5- SMART (ENERGY SAVINGS)

Use this mode for a better energy saving purpose, combined with a maximum water temperature regulation efficiency.

The hot tub control system will always use the external heating system to regulate the water temperature. If the temperature falls too far below your set point (-2.5°F), the internal heater will be activated to help your external heating system reach the set point.

Once the temperature is within 1.5°F from set point, the internal heater is deactivated and the external heating system takes all control of the water regulation again.

** This mode can be set with your in.touch 2 app on a mobile device without the need to open the hot tub skirt to change the jumper setting on the in.grid.*

Troubleshooting

DIAGNOSTIC LED

The diagnostic LED will help you with the status of the connection between the hot tub control system and the in.grid.

Blinking light: Hot tub control system not detected, not compatible or in Disable mode if one of your single switches doesn't operate properly.

Solid light: Hot tub control system detected

No light: Power Off

HEAT LED

Solid light: Relay contacts close and external heating system on.

No light: Relay contacts open and external heating system off.

OPTIONAL ACCESSORIES - IN.TOUCH 2

HOME TRANSMITTER (EN MODULE) INSTALLATION

The Home Transmitter unit must be installed inside the house near the router as it needs to be connected to it. The Home Transmitter is provided with an Ethernet cable and a power supply. If required, a longer cable of good quality can be used by the installer (longer cable not provided) to install the Home Transmitter closer to the hot tub within the home.

The only requirement for installation location is that household current be available to power the Home Transmitter using the provided wall transformer.

The Home Transmitter can be fixed in the house to optimize the signal strength. We recommend that you install the unit with a #8 pan head screw.

Here are some suggestions for a successful installation:

- If possible, install device on the first floor of your house.
- If installing in a basement, place at highest level possible and closest to a window.
- Try to install as far as possible from materials that may interfere with signal (ie. metal structures, thick cement walls).
- Install as far as possible from router as the signal emitted by the antenna may interfere with RF signal.

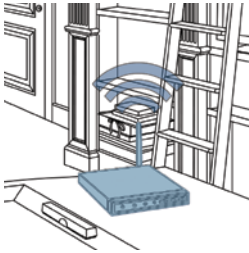

CONNECTION OF THE HOME TRANSMITTER (EN MODULE)

Simply connect Ethernet cable into the RJ45 port of the Home Transmitter and in one of the available LAN ports on the router.

Finally, to power up the Home Transmitter, connect the provided transformer to a 120V (North American model) or 220V (European model) household supply and connect the USB cable between the transformer and the Home Transmitter.

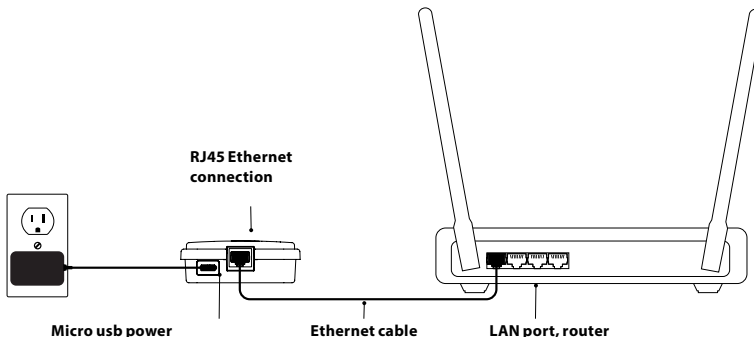

OPTIONAL ACCESSORIES - IN.TOUCH 2

PAIRING THE HOT TUB TRANSMITTER (CO MODULE) AND THE HOME TRANSMITTER (EN MODULE)

The pairing process is used when you need to replace one module of the in.touch 2 kit. Otherwise, the in.touch 2 arrives pre-paired from the factory.

1. Power up the Home Transmitter

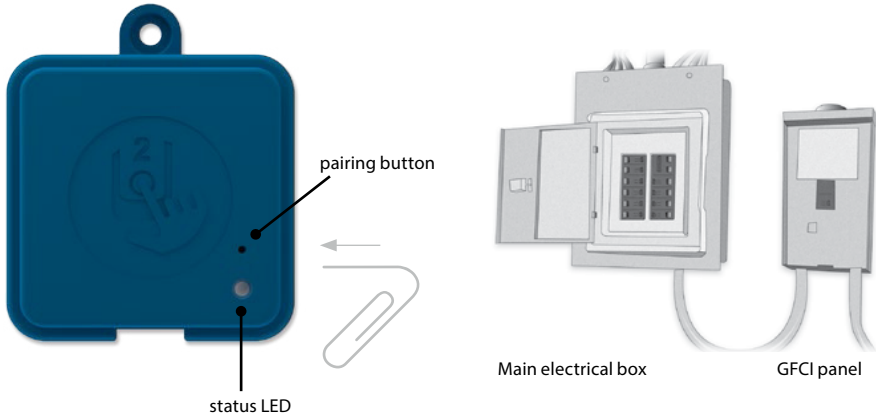

2. Press on the pairing button with a paper clip or some similar tool. When the pairing mode is active the status LED flashes YELLOW in a rapid pattern. The Home Transmitter is then in pairing mode and will remain in this mode until it pairs with a Hot tub Transmitter, or until it is reset (power cycled).

3. Shut off the hot tub's breaker (thus turning off the Hot tub Transmitter), wait a few seconds, and then flip the breaker back on. Within a few seconds, the pairing operation should complete and the Home Transmitter status LED will no longer be YELLOW.

Note: in.touch 2 modules can be paired as often as necessary, but can only be paired with a single counterpart module at a time. Once paired, the modules store this information permanently until the next pairing operation. Pairing information is stored in non-volatile memory, so pairing is not required after a power failure. Only a Home Transmitter can initiate a pairing, so it is important that the pairing begin with putting the Home transmitter module in pairing mode.

If several hot tubs are powered up at the same time with a Home Transmitter in pairing mode (for instance, in a dealer showroom), only the 1st hot tub to successfully connect to the Home Module will pair. As this can be random, it is recommended that only 1 hot tub be powered up at a time during the pairing process.

OPTIONAL ACCESSORIES - IN.TOUCH 2

LED

Each in.touch 2 module has a status LED that can be used for troubleshooting purposes. The LED is located on the top of both enclosures.

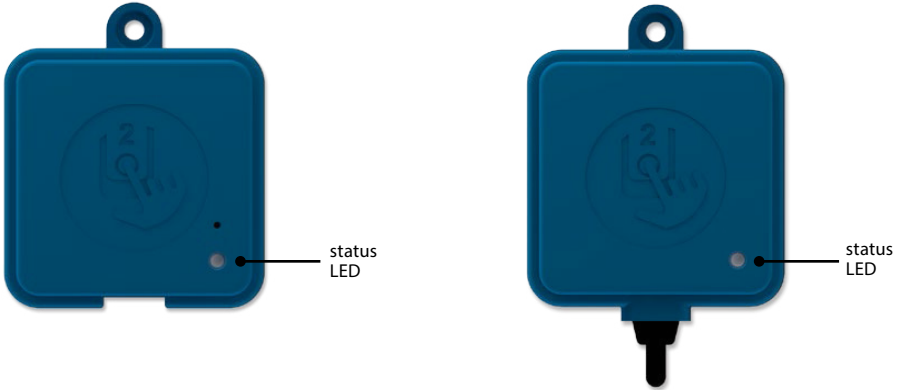

Home Transmitter

Pairing mode Yellow (Blinking)	●
Router not detected	●
Router detected	●
in.touch 2 server detected	●
Module is fully functional	●

Hot tub Transmitter

Pairing mode Yellow (Blinking)	●
Hot tub controller not detected	●
Red	●
in.touch 2 server detected	●
Module is fully functional	●

* When the LED status is blinking (blue, green or red) this indicates that the communication between the EN module and the CO module is not established.

OPTIONAL ACCESSORIES - IN.TOUCH 2

DOWNLOAD APPLICATION



The in.touch app allows you to control your hot tub using your home network or an Internet connection anywhere in the world. The in.touch 2 app is waiting for you in the App Store for iOS devices and on Google Play for Android — search for «in.touch 2» then click on it to install.

USE THIS APP

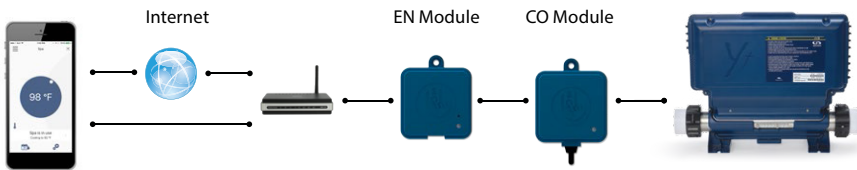

ON YOUR HOME NETWORK

It is possible to access your hot tub with the in.touch 2 app through your home network. To be able to see your in.touch 2 in the application you need to connect your device to the same router (Wi-Fi network) than the one used to connect your Home Transmitter

Go to the Wi-Fi settings section of your mobile device and choose the same network that your hot tub is connected to (i.e. Home). Once you've selected it, wait until your device confirms the connection.

ON THE INTERNET

The in.touch 2 allows you to use the Internet to control your hot tub from anywhere in the world. In order for them to communicate, both the in.touch 2 module and your device must be connected to a network that allows access to the Internet.

Once your Home Transmitter is connected to the Internet (the LED status is blue), you can use your in.touch 2 app any time your device is also connected to the Internet (wireless or cellular network), even if you are away from home.

To have access to your hot tub away from home, you will need to have previously linked your mobile device to your hot tub on your home network.

SETUP YOUR WI-FI ON YOUR DEVICE

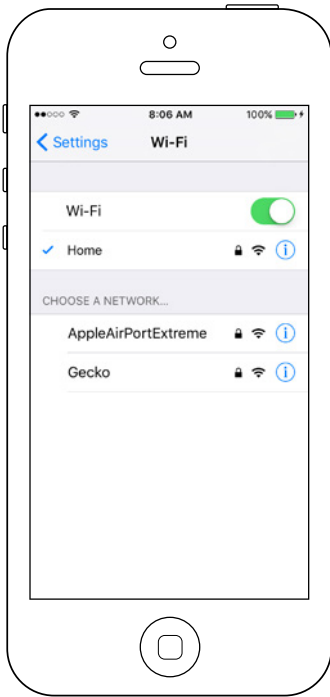

Before using your application, go to the Wi-Fi section of your device's settings. Make sure you are connected to your home network. This needs to be the same Wi-Fi provided by the router to which you connected your Home Transmitter.

OPTIONAL ACCESSORIES - IN.TOUCH 2

START THE IN.TOUCH 2 APPLICATION

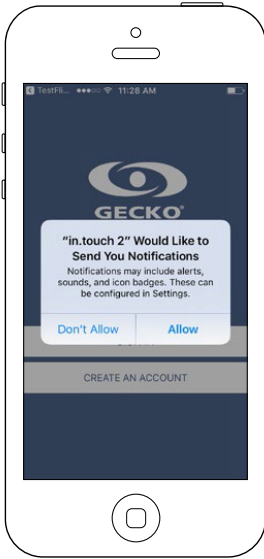

Find the icon for the in.touch 2 application, then tap on it to open it.

The first time you use the application a message will ask you: "in.touch 2" Would like to send you notifications. If you choose Allow, the application will send you notifications about the status of your hot tub. If you choose Don't Allow, the application will not send you notifications.

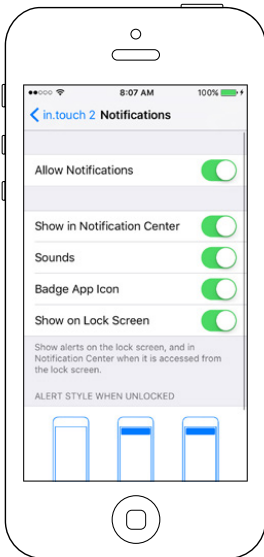

If you change your mind later concerning notifications, you may add or remove notifications for the in.touch 2 application.

On iOS, go in your settings menu and choose in.touch 2. Select the notifications menu, you can turn notifications on or off from this page.

On Android, go to your settings menu and then into the notifications menu. Select the in.touch 2 app, from this page you may turn notifications on or off.

LOGIN PAGE

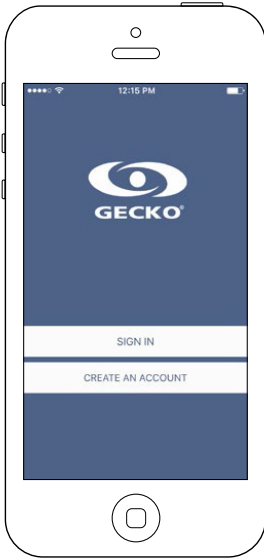

Before using your application, you must create an account first and then, you'll be able to sign in. Your account will give you the opportunity to have access to your hot tub from any in.touch 2 application.

NEW ACCOUNT CREATION

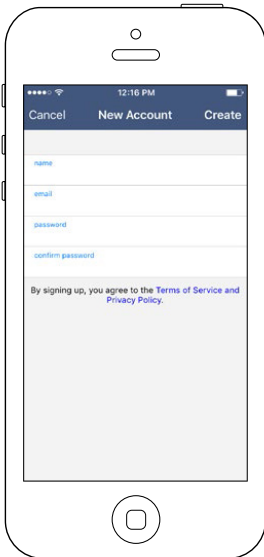

When you choose to create a new account, you agree at the same time our Terms of Service and our Privacy Policy. You can read them at any time through this link:

<https://geckointouch.com/legal>

OPTIONAL ACCESSORIES - IN.TOUCH 2

CHOOSE A SPA

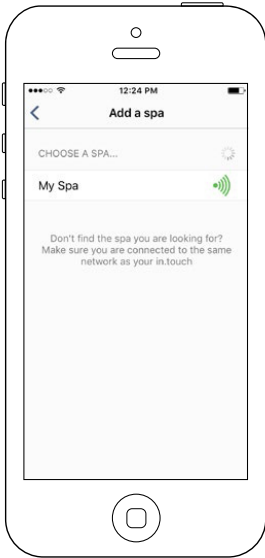





This page displays all the hot tubs detected by your application.

To detect your hot tub, you need to connect your mobile device to the same network to which you connected your Home Transmitter.

Once you have done a connection with the hot tub its name will be saved on this page to allow you to connect to this hot tub from anywhere.

To add a hot tub later on, go to p. 26 of this techbook for instructions. The RF signal strength (communication between the two in.touch 2 transmitters) is illustrated on the Select a spa page. There are 5 possible states:

-  • Signal superior to 80%
-  • Signal between 80% and 51%
-  • Signal between 50% and 31%
-  • Signal below 30%
-  • The Hot tub Transmitter is not available

HOME PAGE

The main screen gives you access to your accessories, water temperature, water care and settings.

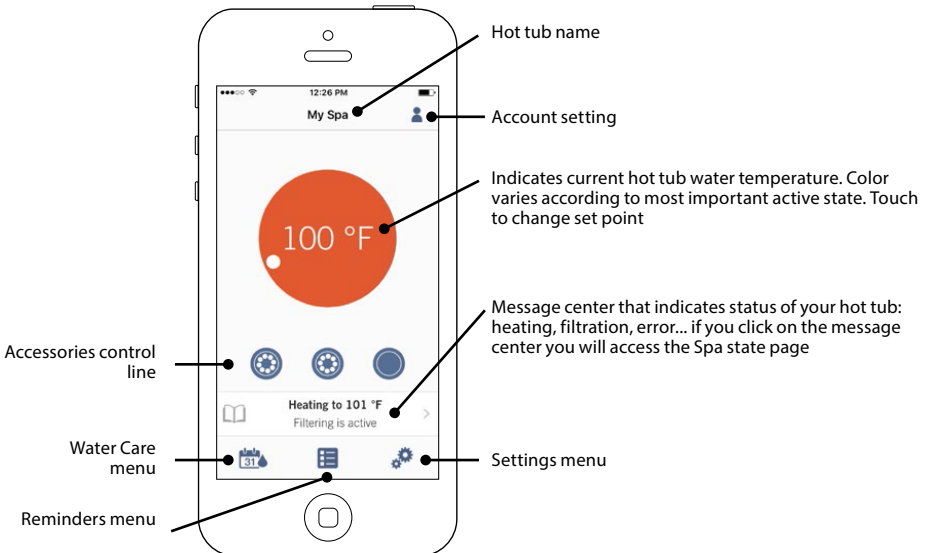

OPTIONAL ACCESSORIES - IN.TOUCH 2

SPA STATE

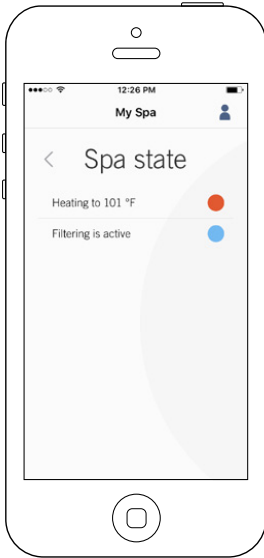

This page displays all the active states of your hot tub. Below is a quick description of each state you may encounter on your hot tub. Each state is associated to a priority and color that determines the color of the widget on the home page.

- Indicates that there is an error on your hot tub.
- Indicates that there is presently an active user demand on your hot tub (ie. pump, blower or light is on).
- Indicates that your hot tub is now heating to your set point.
- Indicates that your hot tub is now in a filtering cycle.
- Indicates that your hot tub is now in economy mode.
- Indicates that your hot tub is running normally (there is no user demand, heating, no filtration or economy active).

The widget on the home page displays a single color at a time. The color displayed is decided by priority of state. The established priority is as listed above.

CHANGE TEMPERATURE

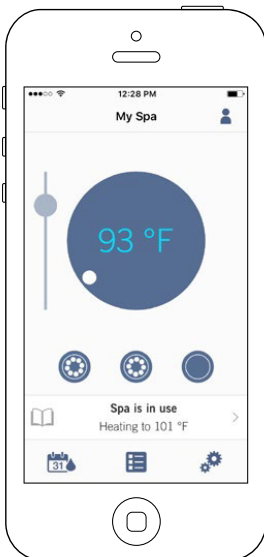

Touch the centered widget to reveal the temperature control bar.

Use the slider on the control bar to change your hot tub's temperature* set point.

** If you are in economy mode your hot tub temperature will be 20°F below your set point.*

OPTIONAL ACCESSORIES - IN.TOUCH 2

TURN ON/OFF ACCESSORIES

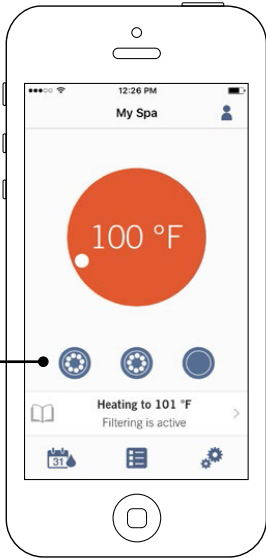

According to your hot tub pack configuration, you can start or stop an accessory by simply touching the associated icon. The icon will become animated when the accessory is on. Simply press on the icon to start or stop the accessory.

If your accessory has more than one speed, press the button until the desired speed is reached.

The icon designs are customized according to your hot tub pack configuration:



TURN ON/OFF THE LIGHTS

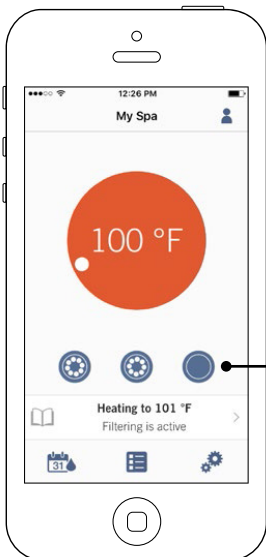

To control your hot tub lights, simply press the button to turn it on or off

OPTIONAL ACCESSORIES - IN.TOUCH 2

CONTROL YOUR IN.MIX 300

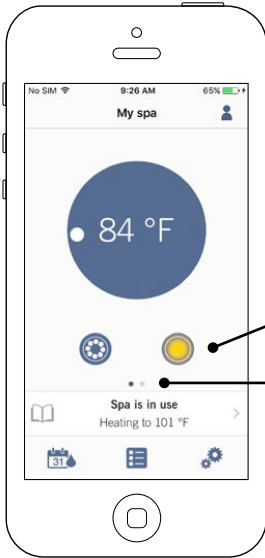

This menu is only available if an in.mix 300 is detected in your hot tub accessories

To turn on or off the in.mix 300, you can use, if you want, the light icon on your home page. To go to your in.mix 300 page, simply swap to the left.

Turn on/off in.mix 300

Swap to in.mix 300

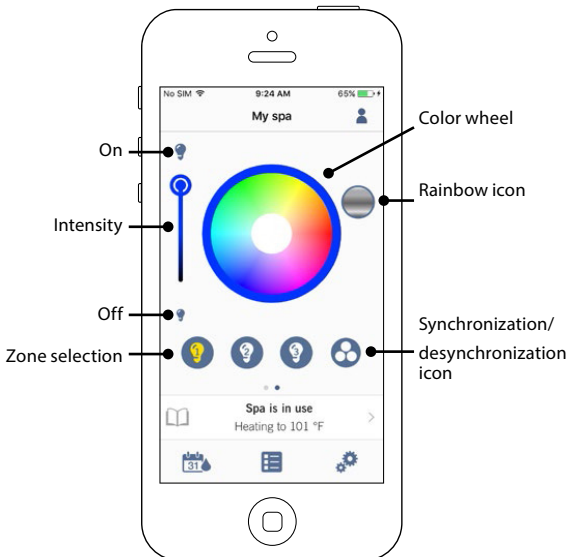

The in.mix 300 page allows you to customize your color zones in or around your hot tub.

The light bulb icons allow you to turn on and off your in.mix 300.

To select a zone, click on the wanted one in the "zone selection" stripe. To change the color, use the color wheel to choose the one you want. On the left side, the intensity slider allows you to modify the brightness of your lights. Use the rainbow icon to get color gradation.

The synchronization / desynchronization icon gives you the possibility to match the color of the selected zone with the other zones

WATER CARE

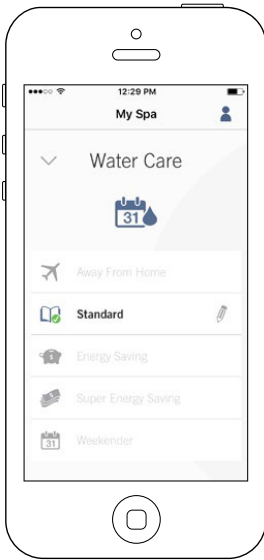

The Water Care page will help you set up your ideal filtration and heating settings. Choose between Away from Home, Beginner, Energy Savings, Super Energy and Weekender, depending on your need. Touch the Water Care name you would like to activate, a green checkmark will appear on the icon, indicating you have selected it.

By default, each Water Care mode has pre-configured schedules of economy and filtration. To modify Water Care options, touch the pencil icon at the right end of the desired Water Care to open its menu.

Below you have a short description of each Water Care at default state:



Away From Home:

In this mode the hot tub will always be in economy; the set point will be reduced by 20° F.



Beginner / Standard:

The hot tub will never be in economy mode and will be filtering according to the pack's low level configuration.



Energy Savings:

The hot tub will be in economy mode during the peak hours of the day and resume normal mode on the weekend.



Super Energy Savings:

The hot tub will always be in economy mode during peak hours, every day of the week.



Weekender:

The hot tub will be in economy mode from Monday to Friday, and will run normally on the weekend.

REMINDERS

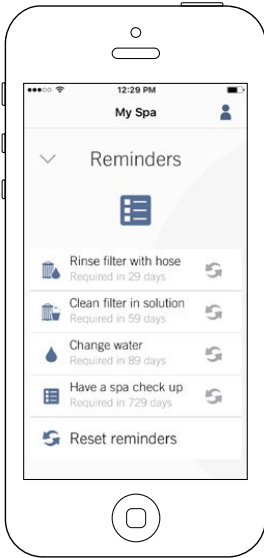

Reminders page will help you to make a follow-up of your maintenance.

The in.touch 2 will remember you to perform required maintenance tasks on your hot tub, such as rinse filter or clean filter. Each task has its own reminder duration based on normal use. The owner can reset his reminders after the hot tub maintenance.

OPTIONAL ACCESSORIES - IN.TOUCH 2

MODIFYING SCHEDULES



In this menu it is possible to add, remove or edit schedules of economy or filtration.

To have access to this menu, simply touch the tabs:

Water Care menu - the little pen at the right of the wanted water care

Touch the Economy tab to modify the economy schedules and Filter cycle tab for the filtration schedules. You can add economy or filtration schedules by touching the « + » symbol.

To delete a schedule, touch the garbage can icon at the right end of the desired line.

You can modify the programmed schedules by selecting one and adjusting the schedule.

You have several possibilities for the schedule (Mon-Fri, weekend, every day, or single days). The schedules will be repeated weekly. The time and duration are set in 30 minute increments. Once you have set the schedule, use the arrow at the top of the page to go back. Ensure that you have selected the desired Water Care mode in the main Water Care menu.

When an economy schedule is active, the set point will be reduced by 20°F, which means that the heating system will not be engaged unless the temperature falls to 20°F below the hot tub's set temperature.

The filtration schedule is applied to the main filtration pump, most likely pump 1. If your hot tub uses a circulation pump configured to run 24 hours, the screen will show purge schedules instead of filtration. The purges are pre-programmed for a fixed number of minutes, therefore the duration will be set to N/A on the screen and only the start time can be modified.

OPTIONAL ACCESSORIES - IN.TOUCH 2

SPA SETTINGS

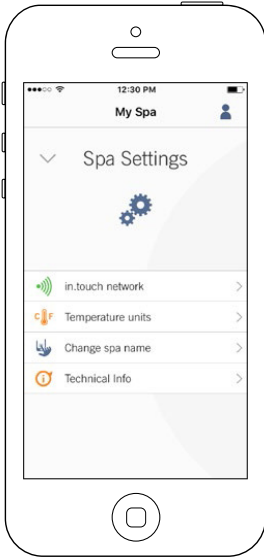

In the Settings page you can access the following:

in.touch network
Temperature units
Change spa name
Technical info

To select an item, tap on the arrow next to it. It will open the selected menu.

IN.TOUCH NETWORK

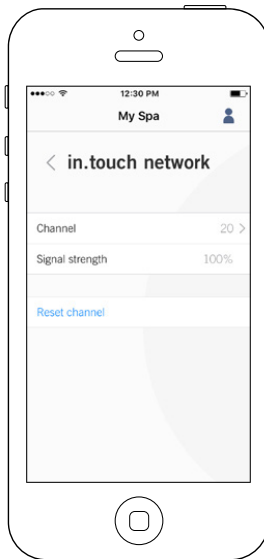
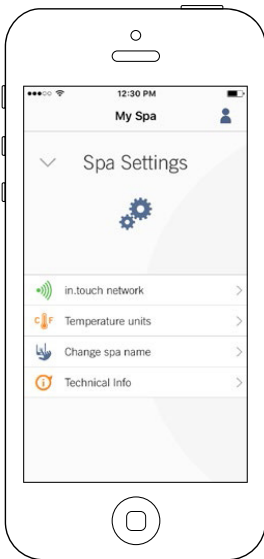

The in.touch network menu allows you to have access to information concerning the RF connection parameters between the Home Transmitter and the Hot tub Transmitter. This menu gives you access to:

Channel
Signal strength
Reset channel (resets channel to ... default)

To change channels, press on the Channel line.

OPTIONAL ACCESSORIES - IN.TOUCH 2

CHANGE CHANNEL



The Change channel page allows you to change the channel used by the two in.touch 2 modules.

In some cases, this can help you to have a stronger signal.

You can have access to this page by touching the following tabs: Spa settings (at the bottom right) - in.touch network - channel

TEMPERATURE UNITS

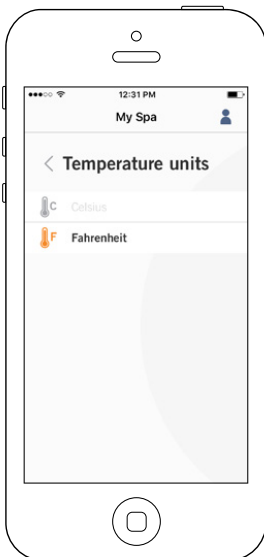

This menu lets you change the units used to display temperature.

You can have access to this page by touching the following tabs: Spa settings (at the bottom right) - temperature units.

OPTIONAL ACCESSORIES - IN.TOUCH 2

NAME

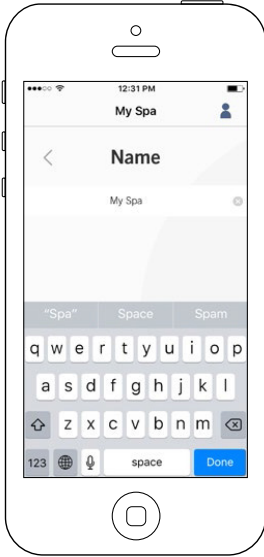

This section allows you to edit the name of the hot tub.

You can have access to this page by touching the following tabs: Spa settings (at the bottom right) - Change hot tub name

TECHNICAL INFO



This section shows information about the in.touch 2 software number and the revision numbers of the different components of your system.

You can have access to this page by touching the following tabs: Spa settings (at the bottom right) - Technical info

SETTINGS

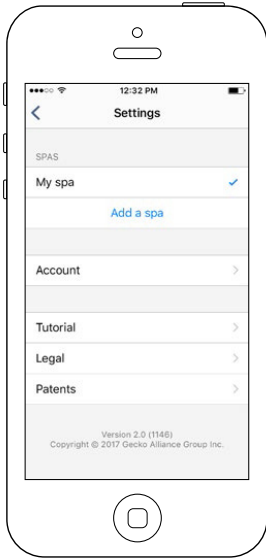

In the Settings page you can access the following:

Add a hot tub from local network
 Account
 Tutorial
 *Legal
 **Patents

To select an item, tap on the arrow next to it. It will open the selected menu.

*The button Legal will bring you to this web site :
<https://geckointouch.com/legal>

**The button Patents will bring you to this web site:
<http://geckoportal.com/corpo/#patents>

ADD A SPA

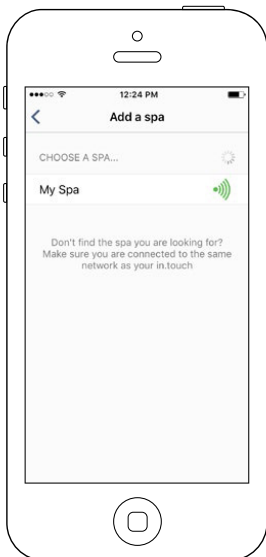





This page displays all the hot tubs detected by your application.

To detect your hot tub, you need to connect your mobile device to the same network to which you connected your Home Transmitter.

Once you have done a connection with the hot tub its name will be saved on this page to allow you to connect to this hot tub from anywhere.

You can have access to this page by touching the following tabs: Settings (up right corner) - Add a spa

The RF signal strength (communication between the two in.touch 2 transmitters) is illustrated on the Select a hot tub page. There are 5 possible states:

-  • Signal superior to 80%
-  • Signal between 80% and 51%
-  • Signal between 50% and 31%
-  • Signal below 30%
-  • The Hot tub Transmitter is not available

ACCOUNT

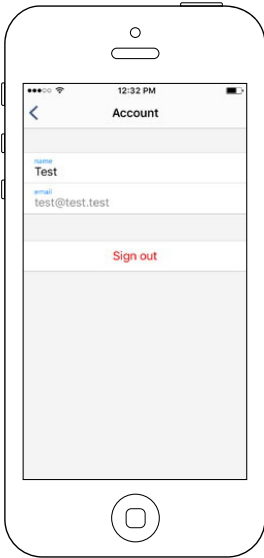

This section gives you access to your account information.

You can have access to this page by touching the following tabs: Settings (up right corner) - account

TUTORIAL

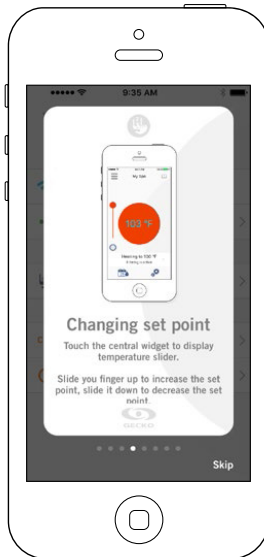
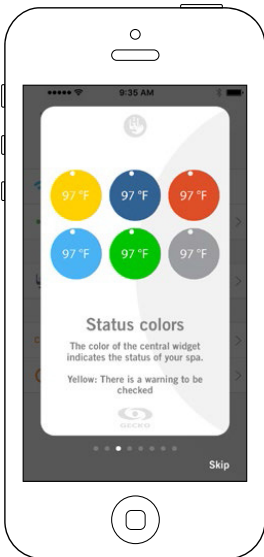

This section gives you a quick overview of your in.touch 2 application's functions.

OPTIONAL ACCESSORIES - IN.TOUCH 2

TECHNICAL SUPPORT INVITATION

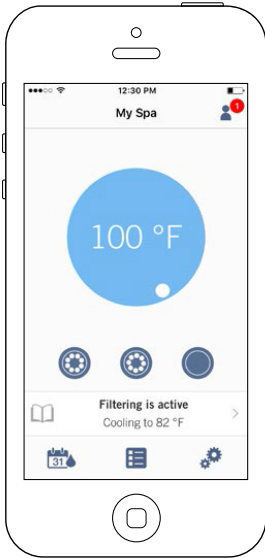

When you receive an invitation for Technical Support, a red circle will be displayed next to the "setting" logo (top right corner).

AUTHORIZING AN INVITATION

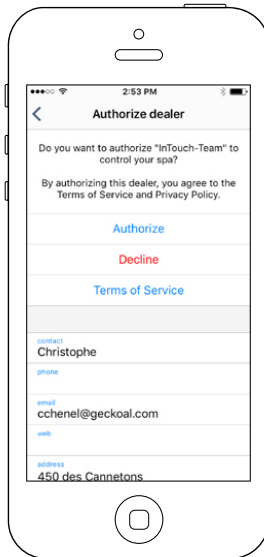
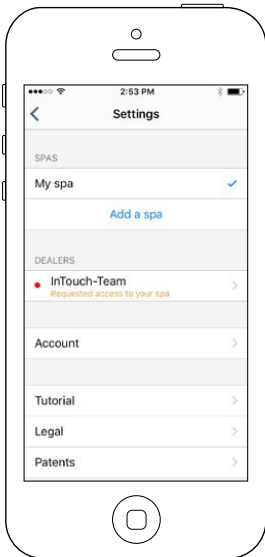

All the invitations you may receive are under the dealers tab in the "settings" menu.

To choose an invitation, simply click on it. You will then see a window authorization to confirm with the dealer's information.

You can also decline the invitation at any time if you want to.

OPTIONAL ACCESSORIES - IN.TOUCH 2

DEALER PAGE



Once you've had a dealer on your in.touch 2 app, you can, at all times, have access to his information.

If you don't want your dealer to have access to your hot tub anymore, simply swap to the left the "Allow access to your spa" button at bottom of the page.

Both in.touch 2 modules have a status LED to help diagnose problems, if any occur.

TROUBLESHOOTING

There are 2 different modules in the in.touch 2 kit: The Home Transmitter (EN Module) and the Hot tub Transmitter (CO Module). They communicate together via an RF link. The Home Transmitter is responsible for the Ethernet communications and the Hot tub Transmitter is responsible for the hot tub communications.

OPTIONAL ACCESSORIES - IN.TOUCH 2

HOME TRANSMITTER (EN MODULE) LED STATUS

This module's LED can show various status conditions, as indicated below.

Rapidly flashing YELLOW color:

The Home Transmitter is in pairing mode when this color is shown (the pairing switch was pressed). Until a pairing successfully completes, the application cannot connect to the hot tub. To complete the pairing, you must turn off the hot tub (using its breaker), wait a few seconds and then flip back the breaker to on. The pairing will then occur within a few seconds. If not, then the Hot tub Transmitter is either incorrectly connected, out of range, or defective.

If the in.touch 2 modules were previously paired and the pairing switch is accidentally pressed, simply unplug the Home Transmitter USB power cord and re-plug it (thereby resetting the Home Transmitter). The modules should then normally reconnect together.

Once out of pairing mode, the Home Transmitter will display another color.

For each of the following colors, the information applies whether the LED is blinking or not. If the LED is blinking, please also refer to the Blinking LED section below.

RED color:

Reason?

The Home Transmitter is not detecting a router. Until this is resolved, the application cannot connect to the hot tub.

What to do?

Make sure the router is powered and working correctly (i.e. test it using another computer or device connected to the same LAN port you intend to use).

Make sure the Ethernet cable is correctly connected at each end (LAN port on router end, and the Home Transmitter.)

If the problem still occurs, try connecting with another cable. If a computer (or other device) works fine on the LAN port, and the cable is fine, then the Home transmitter is likely defective.

GREEN color:

Reason?

The Home Transmitter is connected to a router (an IP address was assigned), but the in.touch 2 server is not reachable.

What to do?

This is very likely a router configuration issue, so refer to your router's User Manual.

It may be due to Port 10022 being closed. Normally, this port is open by default in commercial routers, but different routers may have different behaviors.

If Port 10022 is confirmed as open, then some other internal configuration is preventing the router from accessing Internet. In this case, the application will still have access to the hot tub if connected to the same network.

The server may also simply be temporarily "offline" for servicing/maintenance, so try again later. The application can still connect with the hot tub, but only from within the same network.

If the application can connect to a local hot tub, the problem is likely the Internet connection (WAN), a router mis-configuration, or your Internet Service Provider (ISP) has issues with its network connection.

BLUE color :

Reason?

This is the normal state of the Home Transmitter LED.

It has a full Internet connection, with access to the in.touch 2 server. As long as your device and application have access to the Internet (either via Wi-Fi or cellular data such as 3G, 4G, or LTE), then you're good to go!

What to do?

Enjoy your hot tub!

OPTIONAL ACCESSORIES - IN.TOUCH 2

HOT TUB TRANSMITTER (CO MODULE) LED STATUS

This module's LED can show various status conditions, as shown below.

Rapidly flashing YELLOW color:

The Hot tub Transmitter is in pairing mode when this color is shown. This normally briefly occurs automatically during power-up of the hot tub (i.e. right after the breaker is flipped on). This could also occur if the Hot tub Transmitter was never paired (which is very unlikely, as they are shipped paired from factory). Refer to the pairing section if your unit has not been paired, so you may complete the process.

BLUE color:

Reason?

This is the normal state of the Hot tub Transmitter LED. If the Hot tub Transmitter also shows solid blue, you are all set! If this LED is blinking, refer to the Blinking LED section below.

What to do?

Enjoy your hot tub!

Blinking LED:

On both modules, if the LED is blinking about once per second, it means that the RF link is not established between them (i.e. each in.touch 2 module cannot communicate with its counterpart). This can occur for several reasons.

Review the following and perform the tests in the order given below.

Unpaired:

As the modules are shipped paired from the factory, this is not a likely cause, but it is the easiest test to perform in the field. Simply attempt to pair them again. Please refer to the Pairing section for instructions on pairing.

Modules out of range:

If the pairing test above does not resolve the problem, then the modules may be too far from each other for an effective RF link. To test this, simply connect the Home Transmitter outside, close to the hot tub (via an extension cord for power).

A router connection is not needed for this test. If the module LEDs no longer blink, an RF link was established which confirms the hypothesis that the modules were too far apart. Getting the modules closer together somehow is the only solution.

If moving the modules closer together does not stop the LEDs from blinking, attempt to pair them again. If this pairing fails even though the RF modules are near each other, then one or both of the modules are defective, replace them.

OPTIONAL ACCESSORIES - SAND FILTER SYSTEM

SAND FILTER SYSTEM

ACCESSORIES OF THE SAND FILTRATION SYSTEM:

- filter tank
- prefilter circulation engine
- circulation valve
- silica sand, 0,7 - 1.2 particle size

Operational concept: the water is transported by a circulation engine through a filter housing (which does not contain a filter cartridge), then it passes through the sand filter. Then the filtered water flows through the circulation valve and back to the hot tub. In this case the circulation valve is set to "filtration". Upon inspecting the sand filter's filling you may come across the following issues.

The sand is white when dry: this points to the presence of limescale, in which case there are 2 ways to proceed. Changing the filter sand or applying disinfectant. The sand feels greasy to touch and forms lumps. Take a handful of sand and rub it in your palm. If your skin feels greasy, a layer of biofilm has formed around the sand. The formation of a biofilm layer is often related to lack of rinsing. The actual filter here is the silica sand through which the water passes in a downward flow and the sand filters the particles floating in it. The particle size of the sand (0.7 - 1.2mm) is an important regulation. Part of the sand filtration system is the circulation valve which, depending on its position in relation to the tank, can be a side- or a top valve. The lever on the circulation valve can be used to switch between functions. The sand filter has to be backwashed weekly, since pollution can back up in the sand and obstruct the flow of the water. During backwashing the water flow in the filter is reversed, so any filtered pollution will wash down the drain.

We recommend changing the sand filter every 2 - 3 years.

We recommend disinfecting the sand twice every year. This process involves treating the sand with anti-algae chemicals diluted in water.

LOADING THE SAND FILTER

1. Before loading the sand into the filter put up the filter tank and fasten the pipe links.
2. Remove the lid and seal.
3. Fill the filter with the required amount of sand.
4. Clean the seal's nest on the lid.
5. Put the lid on and tighten it.

FUNCTIONS OF THE CIRCULATION VALVE:

- filtration
- backwashing, rinsing
- postwashing, postrinsing
- flushing
- circulation
- locking

INSTALLATION

After filling the sand filtration tank with sand wash the sand as follows:

1. Set the valve to "RINSE".
2. Open the lockings so that the water flow will not be obstructed and switch on the pump for 3 minutes.
3. Switch the pump off and set the valve to "FILTRATION". After you finish these steps the sand filtration system is ready to filter the hot tub water.

Attention: operate the valve only when the pump is switched off.

FILTRATION

While the pump is switched off set the valve to "FILTRATION". Switch the pump on.

While the pump is on occasionally check the pressure gauge to monitor the fullness of the filter. When the pressure reaches 1.3 kg/cm², perform "RINSING".

RINSING

Every load of sand represents thousands of channels meant to tackle floating particles and keep them within the sand filter, which means that the channels open to water flow are gradually reduced in number. Because of this the pressure within the filter progressively builds up to 1.3 kg/cm². This means that the sand filter is not capable of retaining any more contaminations and cleaning is necessary. Do this as follows. Switch the valve to "RINSING" while the part leading to the drain is open and turn the pump on. Any contamination will flow down the drain.

CIRCULATION

At this setting of the valve the pump moves the water directly into the hot tub without it going through the sand filter.

POSTRINSING

After rinsing the filter and after setting the device to "FILTRATION" the water will be turbid for a few seconds. To avoid mixing the turbid water with the hot tub water set the valve to "POSTRINSING". This should be done as follows. Set the valve to "AFTER-RINSING" right after "RINSING" and switch the pump on for max. 1 minute. This setting will pump the filtered water right down the drain.

FLUSHING

If the hot tub cannot be emptied directly into the drain because there is no drainage at the level of the bottom of the hot tub, flushing can be performed via the filtration pump. To perform flushing set the valve to "FLUSHING". While the valve of the bottom drainage is open, switch the pump on.

Important: ensure that while the pump is switched on the hair filter and full tubing of the bottom drainage is always full of water.

CLOSED

The water flow from the sand filter to the pump is closed in order for the casket of the pump to always be possible to be opened.

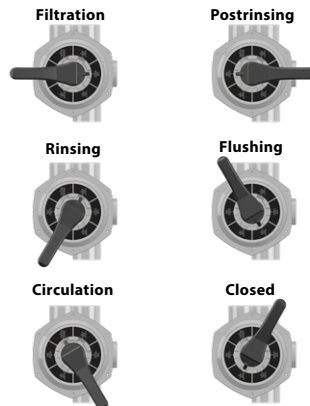

WATER TREATMENT BASICS

WATER TREATMENT BASICS

The chemical equilibrium of the water

The hot tub water will be clean and clear if its chemical components are in equilibrium.

1. pH value:

The first important indicator is the pH value of the water. pH is measured on a scale of 0-14 where 7 is the neutral value. The ideal value is between 7.2 and 7.8 pH. pH values out of this range may irritate the skin.

Under this value the water is acidic, above is basic. The pH value of the human eye is around 7.5, below 7.2 and above 7.8 the water will sting the eyes. Most problems are caused by the pH value being too high. An improper value reduces the effect of the disinfectant.

A high pH value can cause the following problems:

- The disinfectant can be ineffective.
- The solution can exude solid matter.
- The water can become turbid.
- Can cause skin irritation.

A low pH value can cause the following problems:

- The water can become turbid.
- Can cause eye irritation.

Rain or adding fresh water will change the pH value of the water.

2. Disinfection:

Disinfectant is the chemical that eliminates or neutralises the microorganisms (bacteria, algae, fungi, viruses) present in the water. Microorganisms are small microscopic organisms which cannot be detected by the naked eye and are continuously getting into the water through rain, wind, and the bodies of the bathers. If they are not eliminated, they pass from one person to the other through the water (and may cause sickness, infection). Organic matter turns the hot tub water opaque and cloudy.

As we are dealing with warm water hot tubs, bromine or active oxygen is most often used.

3. Preventing growth of algae:

In addition to the disinfection of water the prevention of growth of algae is another key issue. Algae can grow even if proper disinfection and filtration is performed.

Antialgae treatments only work with appropriate pH values.

4. Water hardness:

Water hardness is determined by the quantity of calcium and magnesium salts dissolved in the water. Hard waters contain too much of these dissolved salts and thus scale will form if left alone. Scale can cause significant damage to the walls of the hot tub, piping, filter, heating, and engineering units. In Hungary water is medium hard. Water hardness cannot be reduced by the addition of chemicals, but formation of scale can be prevented.

5. Frothing:

Froth is the smaller-bigger agglomeration of the bubbles and colloid contaminants found on the surface of the water. It is mostly caused by mixing of dirt, cosmetics, body lotions, etc. that soak out of the human skin and the chemicals. It endangers conservation of the aesthetic appearance and cleanliness of the water.

6. Water analysers:

There are several types of water analysers which are mostly used to measure chemical and disinfectant effect. Chemical (pH); Disinfectant (Br, O₃)

Tester types:

Box containing tablets and graduated measuring glass.

Litmus paper indicators in a box.

Chemicals should always be loaded into the filter housing.

Then proper disinfection of the hot tub balance if the chemical levels are not at least 48 hours below the specified value.

Even with the most accurate disinfection after 2-3 months the water quality is no longer maintainable and it is necessary to replace the entire water quantity. In this case we advise you an extensive shock-like disinfection with algae. Dissolve a tablespoonful of algae in the hot tub water and run the engines for 15 minutes. After switching it off for 5 minutes switch it on for another 1-2 minutes, then drain, clean, and rinse the hot tub.

ATTENTION!

Using alcohol- or acetate based cleaning products for cleaning the hot tub is PROHIBITED!

The manufacturer is not responsible for damage resulting from the use of such chemicals.

The chemical treatment of the water should only be done by persons under 18 years of age under parental supervision.

Maintenance should only be performed by qualified professionals.

HOT TUB MAINTENANCE

Do not expose the hot tub to sunlight! Without a thermal cover direct exposure to sunlight can cause discoloration in the water. Use a hot tub cover when you are not using the hot tub, whether it is filled with water or not. Do not expose the hot tub to rain or snow. If possible, build a covering shelter for the hot tub.

The side coating of the hot tub should be protected from high UV exposure (e.g. HOT TUB BAG) and cedar hot tubs should be periodically treated with UV-resistant products. The coating is lined with UV-resistant paint, but because of the previously mentioned factors there is no guarantee that it will prevent fading of color. With cedar coated hot tubs wood treatment is recommended yearly.

1. Periodically drain, clean, and refill the hot tub. We recommend utilizing professional service for the refill.
2. Clean the filter once a month.
3. Shower before stepping into the hot tub.

Maintenance is recommended in the following periods:

- Weekly and before every use Check the hot tub water - see the basics of water treatment
- Every 3 months
- Change the filter cartridges
- Every 3 months Change the hot tub water - see draining the water
- Yearly Inspection of the hot tub is recommended - call a professional for proper inspection.

MAINTENANCE

FILTER CARTRIDGE REMOVAL AND CLEANING

Cleaning mechanical contaminations via continuous water circulation and chemical mixture is a basic requirement for proper cleaning of the hot tub water. Every hot tub has an engine designed for this purpose. The circulation engine circulates the water through the filter(s). The filter protects against contamination floating in the water.

Cleaning of the filter cartridges is recommended weekly.

Soaking the filter cartridges in water mixed with chlorine or antialgae agents for 24 hours is recommended monthly.

Changing the filter cartridges is necessary every 3 months.

SURFACE MAINTENANCE

Wipe the surface with a wet cloth. Always use a neutral cleaning product and a soft wiping cloth. Never scratch the acrylic surface with an abrasive tool, blade, or knife, because it may cause damage. Never use nail polish remover, acetone, or paint stripper when cleaning the surface because it may cause damage.

Maintenance manual for the control panel of the hot tub:

- Do not damage the control panel with anything hard. If possible,
- Avoid exposing the control panel to direct sunlight.
- When not using the hot tub, always use a hot tub cover.

WINTERIZATION

Remember to correctly maintain the hot tub if you are not using it in the winter. If you are not using your hot tub during the winter months and want to put it out of service properly, call one of our qualified professionals to winterize your hot tub at a prearranged date and time.

The winterization encompasses the following:

- Drainage of used water
- Cleaning of the inner surface of the hot tub
- Dewatering of pipe and jet system
- Dewatering and disconnecting the engine's interface
- Delivery - reception

If the hot tub is not winterized properly, the system can retain water that can easily freeze during the winter months. This can cause heavy irreparable damage to the pipes and the engine. This will void the warranty.

Maintenance of the out-of-service hot tub:

When you are not using the hot tub, use the thermo cover and fasten it with the buckles. Do not forget! If the hot tub is filled with water and you are not using it, lift the cover at least once a week to ensure proper ventilation. The thermo cover is multipurpose. Most importantly it decreases the heating time of the water to operational temperature and decreases the energy needed to maintain water temperature, decreasing the operational costs.

Using the cover you can avoid leaves, rain, snow, or other contamination entering the hot tub water, effectively sealing it off from environmental effects.

Fastening the cover with buckles prevents young children from using it without parental supervision.

CLEAN THE FILTER CARTRIDGES WEEKLY AS FOLLOWS:

WARNING!

Changing the filter cartridges is recommended every 3 months!

Operating the hot tub without a filter cartridge is PROHIBITED

1. Remove the lid of the filter.
2. Take out the filter cartridge.
3. Clean contamination from the cartridge with water.
4. Soak the cartridge in lukewarm water mixed with chlorine or antialgae agents for 1-2 hours, then rinse it.

Never use an alkaline detergent or a high-pressure cleaner to clean the filter!



RAINING THE WATER

You can drain the water via the drain outlet in accordance with environmental standards.

1. Find the drainage and remove the cap.
2. Screw on the metric intermediate piece that came with the hot tub.
3. Twist the larger receiving part anticlockwise as much as possible.
4. Pull the receiving part towards you - the water will start flowing from the hot tub.
5. After the water has drained from the hot tub go through the previous steps in a reversed order.

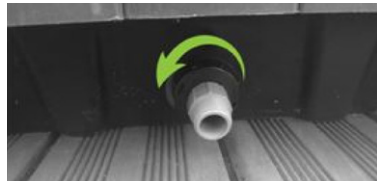
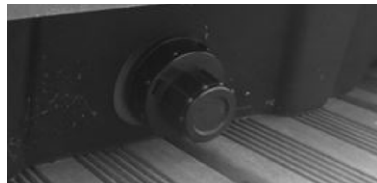

WIRING DIAGRAM - W2000

W2000



OVERVIEW

Probe connectors
(heat.wav's low voltage
cable or regulation probe
and overhear captor
model-re)

Light output (12 V DC)

Communication link
(in.touch or in.stik)

Main keypad
connector

Power output drivers

Pump 1 and
accessory fuse

heat.wav power con-
nection

Bonding lugs

Main power entry
connection

Watertight strain
relief system

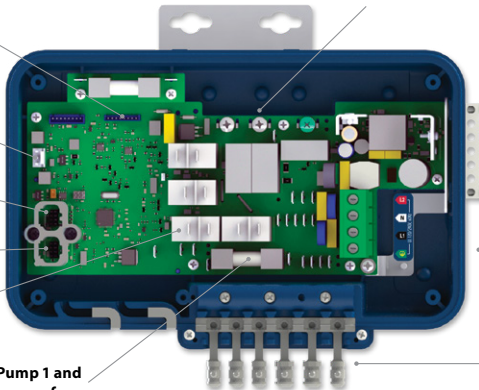

WIRING DIAGRAM - W2000

CONNECTIONS

CONNECTING HIGH VOLTAGE ACCESSORIES: NORTH AMERICAN MODEL IN.YJ

Wires to connect high voltage accessories must have 0.25" quick-connect terminals.

These tabs require high-voltage accessories to have straight, non-insulated, female quick-connect terminals for all connections, including ground. Depending on where the connections are made on the in.yj pack PCB, 120 V and 240 V accessories are supported. Refer to the following tables for correct connections. Note that all female terminals must be correctly and completely seated on the PCB tab for proper current ratings.

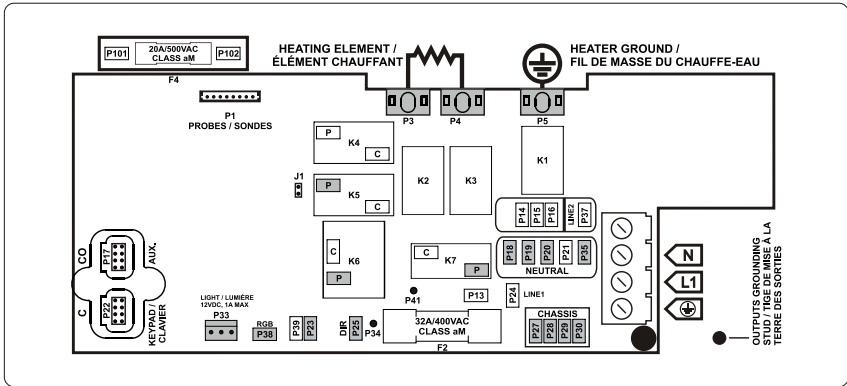

Make sure all accessories are linked to the bonding lug connector located on the side of the hot tub pack.

DIRECT OUTPUT		120 V 240 V	
Voltage			
Green / ground	P27	P27	
Black / line	P25	P25	
White / common	P18	P14	

DIRECT OUTPUT		120 V 240 V	
Voltage			
Green / ground	P28	P28	
Black / low speed	K6-P	K6-P	
Red / high-speed	K7-P	K7-P	
White / common	P19	P15	

PUMP 2 (IN.YJ-3 ONLY)		120 V 240 V	
Voltage			
Green / ground	P29	P29	
Black / low speed	K5-P	K5-P	
White / common	P20	P16	

OZONE (WORKING WITH PUMP 1 LOW SPEED)		120 V 240 V	
Voltage			
Green / ground	P30	P30	
Black / line	P23	P23	
White / common	P35	P37	

LIGHT (12 V DC, 1A)*	
Switch	P33

HEAT.WAV-YJ	
Green / ground	P5
Black / line	P3
White / common	P4

RGB LEDs IN.LU.ME (1A)*	
Switch	P38

* Combination of both outputs is limited to 1A. This table shows typical connections. OEMs may have a different connection scheme.

WIRING DIAGRAM - W2000

CONNECTIONS

CONNECTING HIGH VOLTAGE ACCESSORIES: NORTH AMERICAN HEAT RECOVERY MODEL IN.YJ-RE

These tabs require high-voltage accessories to have straight, non-insulated, female quick-connect terminals for all connections, including ground. Refer to the following tables for correct connections. Note that all female terminals must be correctly and completely seated on the PCB tab for proper current ratings.

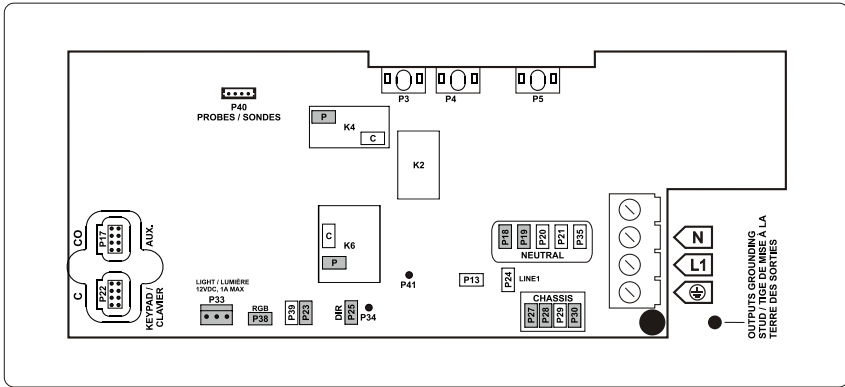

Make sure all accessories are linked to the bonding lug connector located on the side of the hot tub pack.

DIRECT OUTPUT

Voltage	120 V
Green / ground	P27
Black / line	P25
White / common	P18

DIRECT OUTPUT

Voltage	120 V
Green / ground	P28
Black / low speed	K6-P
Red / high-speed	K4-P
White / common	P19

OZONATEUR

Voltage	120 V
Green / ground	P30
Black / line	P23
White / common	P35

Light (12 V DC, 1A)*

Switch	P33
--------	-----

RGB LEDS IN.LU.ME (1A)*

Switch	P38
--------	-----

* Combination of both outputs is limited to 1A.

This table shows typical connections. OEMs may have a different connection scheme.

WIRING DIAGRAM - W2000

CONNECTIONS

COMPLETING THE INSTALLATION

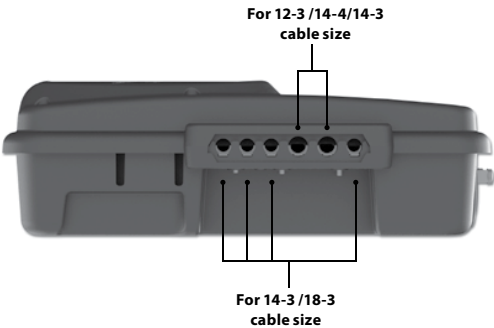
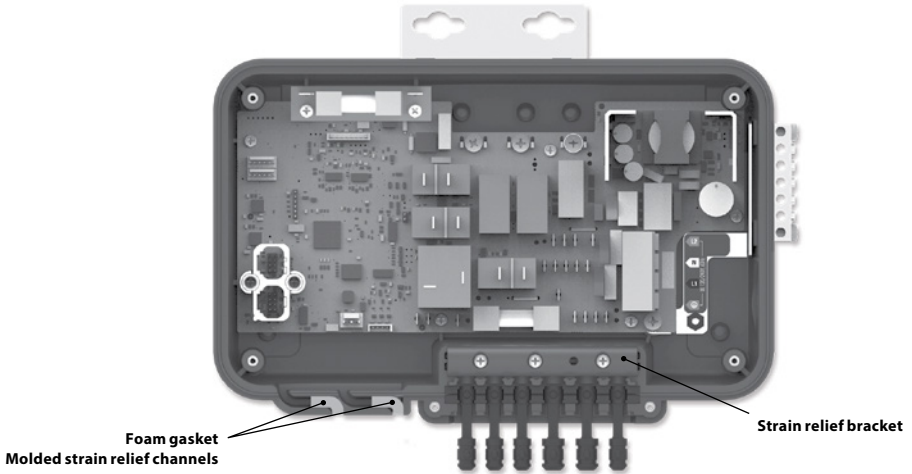

Output cable opening size

WIRING DIAGRAM - W2000

ELECTRICAL WIRING

ELECTRICAL WIRING: ALL MODELS

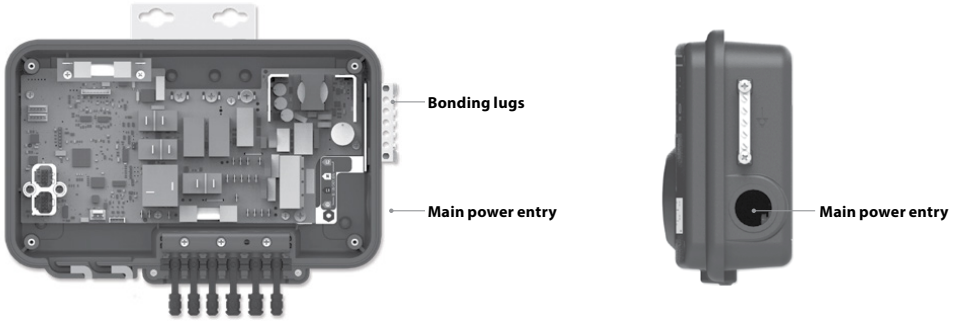

WARNING!

Disconnect power before starting electrical work. Wiring must be completed by a qualified electrician and must be done in accordance with the local electrical code.

Do not use a wire gauge bigger than 8 AWG.

To complete the electrical connections of the in.yj control system you will need a Phillips screwdriver and a flat-head screwdriver.

Remove the screws from the system control lid and remove it.

Remove 5 1/2" (142 mm) of cable insulation.

Strip away 1/2" (15 mm) of insulation from each wire.

Pull the cable through the cutout of the box and secure it with a 3/4" NPT strain relief* (hole diameter 1.09" [27.6 mm]). Ensure that the NPT strain relief clamps around the outer sheath of the cable.

*** For CE/AUS/NZ use an IEC certified plastic bushing that will maintain the IPX5 rating.**

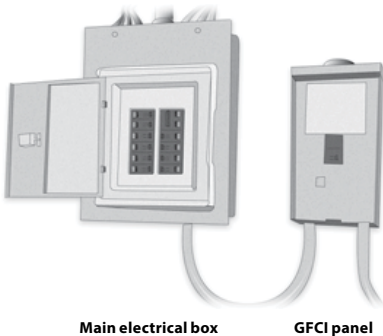

WARNING!

For units for use in other than single-family dwellings, a clearly labeled emergency switch shall be provided as part of the installation. The switch shall be readily accessible to the occupants and shall be installed at least 5' (1.52 m) away, adjacent to, and within sight of the unit.

This product must always be connected to a circuit protected by a ground fault interrupter.

Proper wiring of the electrical service box, GFCI and in.yj terminal block is essential!

Check your electrical code for local regulations. Only copper wire should be used, never aluminum.

Disposal of the product



The appliance (or the product) must be disposed of separately in accordance with the local waste disposal legislation in force.

WIRING DIAGRAM - W2000

ELECTRICAL WIRING

ELECTRICAL WIRING: NORTH AMERICAN MODEL

Refer to wiring diagram in the enclosure box lid for more information.

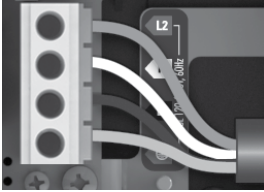

120 V (3 WIRES)

DO NOT REMOVE THE BROWN WIRE. Insert each wire into the appropriate socket of the main entry terminal block according to the color code indicated on the sticker. Use a flat screwdriver to tighten the screws on the terminal.

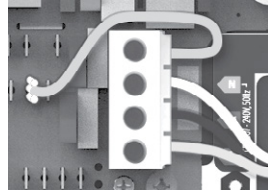

240 V (4 WIRES)

Remove the brown wire and insert each wire into the appropriate socket of the main entry terminal block according to the color code indicated on the sticker. Use a flat screwdriver to tighten the screws on the terminal.

After making sure wires are securely connected, push them back into the box and replace the cover. Do not over tighten cover screws (torque to 8 in.lb max {0.9 N.m.}). Connect the bonding conductor to the bonding lug on the side of the hot tub pack (a grounded electrode conductor should be used to connect the equipment grounding conductors).

WIRING DIAGRAM - W3000 & W5000

CONNECTIONS

CONNECTING HIGH VOLTAGE ACCESSORIES: ALL MODELS

Two options are available with Y Series hot tub packs for connecting high voltage accessories: 0.250" quick-connect terminals, or AMP connectors conform to industry standards.

CONNECTING HIGH VOLTAGE ACCESSORIES: NORTH AMERICAN MODEL IN.YE

For the connection to the 0.250 inch terminals, the high voltage accessories must be provided with female quick connect terminals, straight and non-insulated for all types of connections, including the ground. Accessories of 120 V or 240 V may be connected to the corresponding terminals of the printed circuit of the in.ye. Refer to the following tables for correct connections. Note that all female terminals must be correctly and completely seated on the printed circuit terminals for proper current ratings.

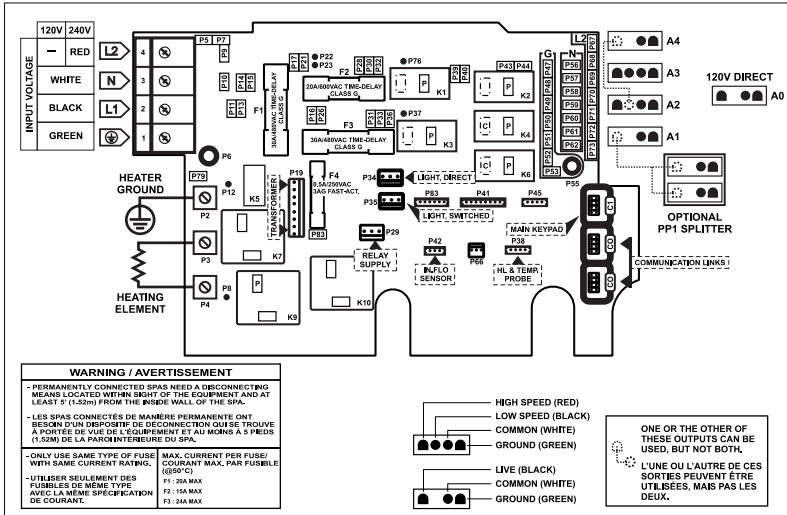

DIRECT OUTPUT 1

(A0 / Floating connector) (in.ye-5 only)

Voltage	120 V	240 V
Green / ground	P47	P47
Black / line	P32	P32
White / common	P56	P67

PUMP 3 (A4)

(in.ye-5 only)

Voltage	120 V	240 V
Green / ground	P48	P48
Black / line	K6-P	K6-P
White / common	P57	P68

PUMP 1 (A3)

Voltage	120 V	240 V
Green / ground	P49	P49
Black / low speed	K2-P	K2-P
Red / high speed	K4-P	K4-P
White / common	P58	P69

CIRCULATION PUMP* (A1)

Voltage	120 V	240 V
Green / ground	P51	P51
Black / line	K1-P	K1-P
White / common	P60	P71

PUMP 2 (A2)

(in.ye-5 only)

Voltage	120 V	240 V
Green / ground	P50	P50
Black / low speed	K6-P	K6-P
Red / high speed	K3-P	K3-P
White / common	P59	P70

PUMP 2 (A2)

(in.ye-3 only)

Voltage	120 V	240 V
Green / ground	P50	P50
Black / low speed	K2-P	K2-P
White / common	P59	P70

LIGHT (12 V AC, 1A MAX.)

Always on	P34
Relay	P35

* Ozonator and circulation pump can be combined on the same output via the optional splitter PP1.

This table shows typical connections. OEMs may have a different connection scheme.

WIRING DIAGRAM - W3000 & W5000

CONNECTIONS

HEAT.WAV WATER HEATER CONNECTIONS

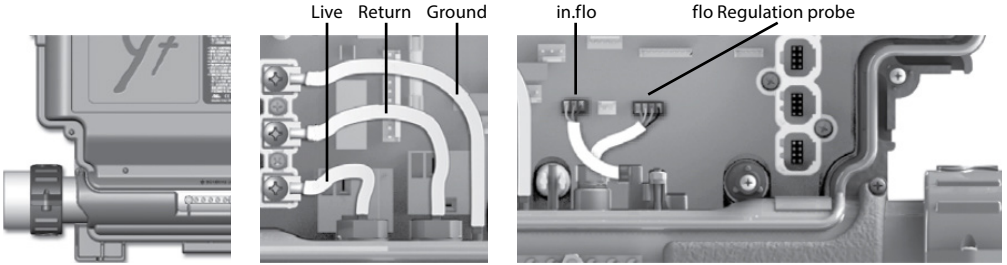

All Y Series systems come with a high performance heat.wav heater. With no pressure switch, it features in.flo integrated dry-fire protection.

The heat.wav heater is factory configured for 240 V / 4 kW, but it can be converted to a dedicated 120 V / 1 kW by simply adding a cable connection. (120 V conversion is available on North American in.ye-3 models only).

The heat.wav heater is also offered in 240 V / 5,5 kW or 240 V / 2 kW versions.

heat.wav specification summary:

- Supports 120 V or 240 V
- Incoloy® heater element
- Protected by external breaker (not fused)*

** Note: European models are 230-240 V only and are fuse protected.*

Part numbers:

9917-101959 (cable for conversion)

9920-101449 (5.5 kW heat.wav heater)

All heater connections are accessible when the cover is removed. Connections include the in.flo dry-fire protection, hi-limit/regulation probe connectors, power and ground cable connections.

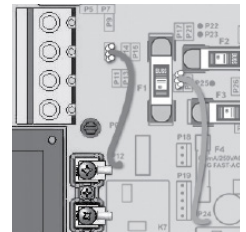
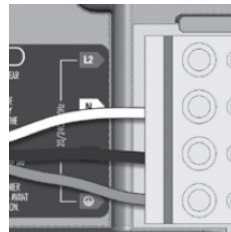
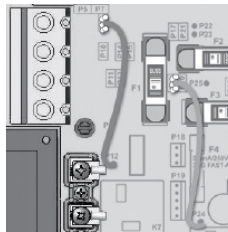
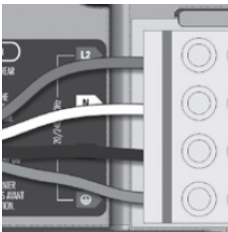

Connections for 120 V heaters (1 kW)

BROWN wire must be correctly connected between P12 and P10.

For early North American version installations the YELLOW wire must be between P25 and P20.

The ORANGE wire must be between P24 and P16.

Connections for 240 V heaters (North American installations only).

BROWN wire must be correctly connected between P12 and P9.

Note: To convert model to a 120 V system, the white (common) accessory wire must be moved. See wiring diagram for details.

WIRING DIAGRAM - W8000

CONNECTIONS

CONNECTING HIGH VOLTAGE ACCESSORIES: NORTH AMERICAN MODEL IN.YT

For the connection to the 0.250 inch terminals, the high voltage accessories must be provided with female quick connect terminals, straight and non-insulated for all types of connections, including the ground. Accessories of 120 V or 240 V may be connected to the corresponding terminals of the printed circuit of the in.yt. Refer to the following tables for correct connections. Note that all female terminals must be correctly and completely seated on the printed circuit terminals for proper current ratings.

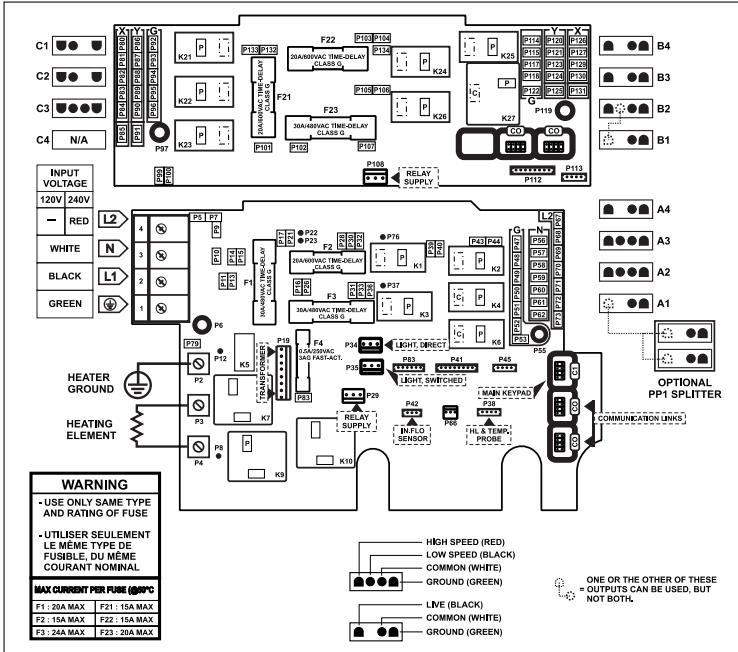

DIRECT OUTPUT 1 (A4)	
Voltage	120 V 240 V
Green / ground	P48 P48
Black / line	P32 P32
White / common	P57 P68

DIRECT OUTPUT 2 (C1)	
Voltage	120 V 240 V
Green / ground	P92 P92
Black / line	P132 P132
White / common	P86 P80

AUXILIARY (B1) (IN.YT-12 ONLY)	
Voltage	120 V 240 V
Green / ground	P118 P118
Black / line	K26-P K26-P
White / common	P124 P130

PUMP 1 (A3)	
Voltage	120 V 240 V
Green / ground	P49 P49
Black / low speed	K2-P K2-P
Red / high speed	K4-P K4-P
White / common	P58 P69

PUMP 2 (A2)	
Voltage	120 V 240 V
Green / ground	P50 P50
Black / low speed	K6-P K6-P
Red / high speed	K3-P K3-P
White / common	P59 P70

PUMP 3 (C3)	
Voltage	120 V 240 V
Green / ground	P94 P94
Black / low speed	K22-P K22-P
Red / high speed	K21-P K21-P
White / common	P88 P82

PUMP 4 (B2) (IN.YT-12 ONLY)	
Voltage	120 V 240 V
Green / ground	P117 P117
Black / low speed	K26-P K26-P
Red / high speed	K27-P K27-P
White / common	P123 P129

PUMP 5 (B3) (IN.YT-12 ONLY)	
Voltage	120 V 240 V
Green / ground	P115 P115
Black / line	K24-P K24-P
White / common	P121 P127

BLOWER (B4) (IN.YT-12 ONLY)	
Voltage	120 V 240 V
Green / ground	P114 P114
Black / line	K25-P K25-P
White / common	P120 P126

CIRCULATION PUMP (C2) (IN.YT-7)	
Voltage	120 V 240 V
Green / ground	P93 P93
Black / line	K22-P K22-P
White / common	P87 P81

CIRCULATION PUMP (C2) (IN.YT-12)	
Voltage	120 V 240 V
Green / ground	P93 P93
Black / line	K23-P K23-P
White / common	P87 P81

OZONATOR (A1)	
Voltage	120 V 240 V
Green / ground	P51 P51
Black / line	K1-P K1-P
White / common	P60 P71

LIGHT (12 V AC, 1A MAX.)	
Always on	P34
Relay	P35

WIRING DIAGRAM - W8000

CONNECTIONS

HEAT.WAV WATER HEATER CONNECTIONS

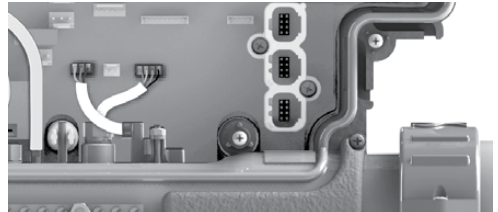
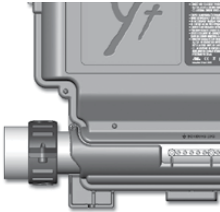

All Y Series systems come with a high performance heat.wav heater. With no pressure switch, it features in.flo integrated dry-fire protection.

The heat.wav heater is factory configured for 240 V / 4 kW, but it can be converted to a dedicated 120 V / 1 kW by simply adding a cable connection. (120 V conversion is available on North American in.ye-3 models only).

The heat.wav heater is also offered in 240 V / 5,5 kW or 240 V / 2 kW versions.

heat.wav specification summary:

- Supports 120 V or 240 V
- Incoloy® heater element
- Protected by external breaker (not fused)*

***Note: European models are 230-240 V only and are fuse protected**

Part numbers:

9917-101959 (cable for conversion)

9920-101449 (5.5 kW heat.wav heater)

All heater connections are accessible when the cover is removed. Connections include the in.flo dry-fire protection, hi-limit/regulation probe connectors, power and ground cable connections.

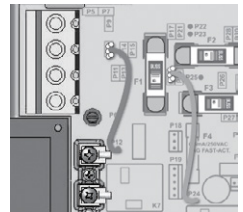
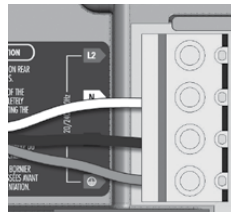
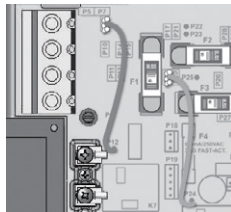
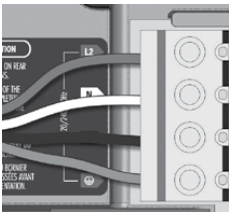

Connections for 240 V heaters (North American installations only)

BROWN wire must be correctly connected between P12 and P9.

For early North American version installations the YELLOW wire must be between P25 and P20. the ORANGE wire must be between P24 and P16.

Connections for 120 V heaters (1 kW)

BROWN wire must be correctly connected between P12 and P10.

Note: To convert model to a 120 V system, the white (common) accessory wire must be moved. See wiring diagram for details.

BREAKER SETTING

POWER UP AND BREAKER SETTING

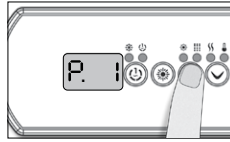
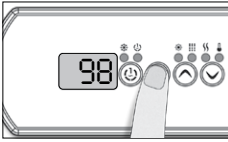

It is important to specify the current rating of the GFCI/RCD used to ensure a safe and efficient current management (and reduce nuisance GFCI/RCD trippings).

Press and hold the Prog. button until you access the breaker setting menu. (the programming menu will appear first). If your control system is equipped with the phase configuration menu, it will appear before the breaker setting menu.

Note: if the keypad does not have the Prog. Key, use the Light key.

For color display keypad go in setting menu.

The tables below indicate the typical value of b for different GFCI/RCD ratings.

Choose the one that corresponds to your breaker.

Note: Every OEM has its own pre-established configurations.

Choose the number of phases supplying your hot tub (1 to 3). Use the **Up** or **Down** keys to select the number of phases and press on the **Prog.** key to confirm your selection.

The values displayed by the system correspond to 80% of the maximum amperage capacity of the GFCI.

Use the Up or Down keys to choose the desired value.

The value can typically be modified from 10 to 48 A.

Press on the Prog. key to set the breaker rating.



W3000, W5000

GFCI/RCD	b
60A	48A
50A	40A
40A	32A
30A	24A
20A	16A

* Only available on in.yj-3.

BREAKER SETTING

POWER UP AND BREAKER SETTING

IMPORTANT Please read the following before starting the device.

Verify that all accessories are linked to the ground lug and connected to the to the control system.

A minimum flow of 68 LPM (18 GPM) is required. Make sure that all valves are open in the hot tub plumbing and that the water flow is sufficient between the main pump and the water heater.

Turn on the breaker.

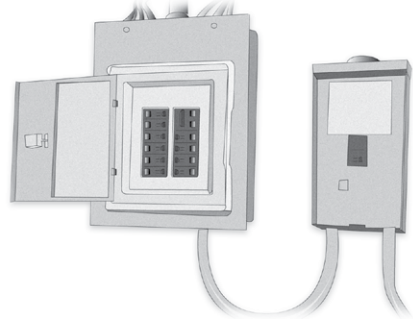

IN.FLO DRY-FIRE PROTECTION

At start up, the in.flo's detector verifies the water flow according to the following sequence:

The Pump 1 or the circulation pump runs for a period of 2 to 5 minutes.

The display will show "--" during the flow verification. After this time, the system confirms if flow is adequate or not.

If the flow is sufficient, the temperature of the water is displayed on the keypad screen. When the water has reached the consigned temperature plus 0.45°C (0.8°F), the water heater turns off.

DISPLAY SEQUENCE AT START UP (EVERY PARAMETER IS DISPLAYED FOR 2 SECONDS)



Lamp test

All segments and LEDs light up.



Software number

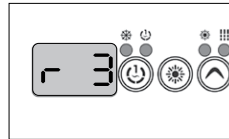

Software revision

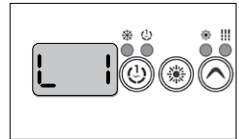

Low-level selected

Low-level selected from the low-level menu.

FREQUENTLY ASKED QUESTIONS

QUESTIONS CONCERNING CLEANING, WATER TREATMENT, AND MAINTENANCE

What should I do if the filter of the hot tub is polluted?

Clean the filter every week or two weeks with a jet of water. Periodically, depending on usage, soak the filter in water mixed with an antialgae agent for 1-2 hours, then rinse it.

Should I shower before using the hot tub?

Yes, thoroughly.

Should the side cover of the hot tub be treated?

The side cover is made from weather resistant plastic. It does not require treatment or maintenance (except if it is a cedar cover).

How often should the water be changed if my hot tub has the in.clear water maintenance system? Does it maintain water quality?

With the cutting-edge automated brominating in.clear system water only has to be changed approximately once every 6 months. This can be even longer if the hot tub is not used daily. Adding water and Trublu (sodium bromide) may be necessary if the water level decreases because of splashing or evaporation. Optional UV-C antibacterial agents, disinfectant, and a sterilization system are available for our hot tubs. These guarantee fresh and pure water using 30-50% fewer chemicals.

What kind of water treatment do you recommend in case of communal use?

In case of communal use we recommend the optional sand filtration device that comes in place of the standard antibacterial filter. In case of heavy usage we recommend the automated monitoring-, regulating-, and chemical dispenser device.

I cannot stop the heavy foaming. Before using the hot tub we shower without using soap and I use the necessary chemicals. Did I use too little?

As described in the user guide of the products, apply 1-2 cups of antifoaming agent to the hot tub water. Wait for the chemical to thoroughly mix with the water. Repeat if necessary. If the problem is still present, check and readjust the pH value. If foaming still occurs, disinfect the hot tub with an antialgae chemical containing free active chlorine, then drain, clean, rinse, and refill the hot tub.

PREPARATION OF THE INSTALLATION SITE

What are the most important concerns when selecting the installation site?

The installation site should be prepared in accordance with the installation guide by a professional. The devices can only be installed and set up at appropriate installation sites. Make sure there is an appropriate cable length, electric supply, a 30mA protective relay, and with certain products a floor drain.

Is a floor drain necessary for an indoor hot tub?

Building a floor drain is mandatory!

TECHNICAL DATE OF THE PRODUCT, USAGE

What type of water circulation engine is used for massage hot tubs?

Our massage hot tubs are equipped with Laing low power (110W) energy saving, silent circulating motor pumps.

What is the maximal temperature that does not damage the hot tub?

The water temperature can be adjusted to between 26 and 40 degrees Celsius.

What is the recommended optimal water temperature?

32-38 degrees Celsius. If young children are using the hot tub, lower temperature is recommended. Always check the water temperature before the child steps into the hot tub and make sure that the temperature is suitable for the child.

Can the system freeze? Is there a sensor that starts emergency heating in case of freezing?

In the winter the unused hot tub should be winterized. After draining the hot tub we will defrost the system as necessary, meaning that we will remove the water retained by the engine and the pipes. For details and pricing please call our customer service. If the hot tub remains in use during the winter, the engines start if there is a danger of freezing and heat the water to 8°C

Can the system be programmed to start heating at certain time?

There is no way of setting a time and date for automatic heating. Because of concerns of energy efficiency heating the water to greater temperatures is not recommended in case of multiple weekly usage.

Can the hot tub be controlled remotely?

Our premium category massage hot tubs come with a Balboa Colossus control system that can be controlled via an app designed for IOS and Android (Windows is not supported). The app makes remote access and control possible. You can access the controls of your massage hot tub anywhere, adjust the water temperature, circulation, lighting, and check the status of the hot tub from afar.

The jet of the hot tub shuts down automatically after 15 minutes of operation. Can I restart it immediately, or do I have to wait? Can I restart it as many times as I want without a break? How does this affect the jets?

The hydromassage system shuts down every 15 minutes for security reasons - to avoid possible muscle soreness. It can be restarted for any amount of times and without a break.

Is this the same for the bubble massage function?

Yes, it is the same for the bubble massage function.

FREQUENTLY ASKED QUESTIONS

When we do not use the hot tub often, mostly in the winter (around 3 times a week), which is the most energy efficient setting, taking into account the energy necessary for reheating? We only use it a couple of times a week, 37 degrees Celsius is our favourite temperature. Should it be in Sleep or Economy mode? Should I switch to the Standard setting only when heating the hot tub? Or should it always stay on Standard?

If you only use it 2-3 times a week, the most efficient way is to keep the water at operational temperature (38 degrees Celsius). Thanks to the excellent insulation and the thermo cover this setting requires less energy than letting the water cool down and reheating it before usage. The heating system automatically switches on in case the water temperature drops more than half a degree Celsius. In the summer the Economy setting is recommended as the external temperature is usually high. Only use the Sleep setting if you are not using the hot tub for a longer period of time (3-4 weeks).

Does the hot tub switch back to the last used setting if there is a power outage?

When connecting the hot tub to the power supply it switches to charging mode. Push the "Temp" button to set it to the Standard setting and it will display the water temperature. The hot tub will switch back to the last used setting after a power outage.

Can the filtration cycle only be programmed to 1-8 hour periods? Is there something like a 3-hour period? What is ideal and what is adequate?

The filtration cycle can be set to 1-8 hour or continuous settings. If you have a hot tub equipped with the in.clear automatic water management system, a daily 8-hour circulation period is recommended to produce necessary amounts of bromine. The 8-hour (2x4 hour) setting is ideal.

Can the operating device for our hot tub be placed in an external location where only the staff can access it?

The operating device can only be placed 5 meters cable length away from the hot tub.

What is the service life of the UV-C lamp?

If the filtration cycle is set to the continuous (0-24) setting, then the service life of the UV-C lamp is 8000-9000 hours. With continuous setting the most effective water disinfectant system can reduce the necessary amount of chemicals by 30-50% depending on usage.

IN.CLEAR

Why is the water turbulent/oily?

If the water is turbulent or oily after heavy usage, perform a refill and wait 24 hours until conditions are suitable for usage. If the problem persists, contact your service provider to perform the necessary water equilibration.

Does sodium-bromide vaporize?

No. Sodium-bromide will only leave the hot tub in case of splashing, leaking, or draining.

What should I use to clean my hot tub?

Only nonfoaming nonacetic cleaning products available at professional dealerships.

If the in.clear bromine generator is switched off, is the hot tub still being disinfected by sodium bromide?

No. The in.clear system does not disinfect while switched off. However, if there is a level of bromine left over in the water, it will continue the disinfecting process. The In.clear system can be switched off for certain periods of time and the hot tub will remain nice and clean. Sodium bromide becomes bromine when it passes through the electrodes of the in.clear system, while the pump connected to the in.clear system is operational.

The products included in the user manual are for illustration purposes only, and may not always match the specifications of the advertised product. Manufacturer reserves the right to modify the products – including the product range – without prior notice since they are valid at the time they are delivered to the printing press. We may not be made responsible for printing errors.

