



USER MANUAL FOR HOT TUB

/ CONTROL SYSTEMS / KEYPADS / ACCESSORIES /



WARNING

REDUCE THE RISK OF ELECTROCUTION

- Never place an electric appliance within 5 feet of hot tub.

REDUCE THE RISK OF CHILD DROWNING

- Supervise children at all times.
- Attach hot tub cover after each use.

REDUCE THE RISK OF OVERHEATING

- Check with a doctor before use if pregnant, diabetic, in poor health, or under medical care.
- Exit immediately if uncomfortable, dizzy, or sleepy. Hot tub heat can cause hyperthermia and unconsciousness.
- Hot tub heat in conjunction with alcohol, drugs, or medication can cause unconsciousness.

WHEN PREGNANT, water temperature before entering.

- Soaking in hot water for long periods can harm your fetus. Measure
- Exit immediately if uncomfortable, dizzy, or sleepy. Hot tub heat can cause hyperthermia and unconsciousness.
- Hot tub heat in conjunction with alcohol, drugs, or medication can cause unconsciousness.

TABLE OF CONTENTS

Introduction	4
Safety instructions	5
Safety instructions - Canada	12
Important safety instructions	15
Initial installation	16
Basic functions	17
Initial installation	18
Major components of the product	20
User interface	
K300	35
K500	38
K1000	48
Optional accessories	
My Music...	60
UV-C / Ozone	61
in.touch 2	62
Maintenance	85
Wiring diagram	
W2000	86
W3000 & W5000	89
W8000	91
Breaker setting	93
Frequently asked questions	95

INTRODUCTION

Congratulations on your new product!

Outside work and family the enjoyment of quality life and calm moments plays an important role in the life of a 21st century man. An evening bath in the hot tub or tub alone or in company can give you the opportunity to lose track of time and your body and soul can relax. From the world of rationality we get into the world of senses where the cossetting atmosphere of the water provides the perfect conditions for relaxation.

Our design engineers utilised the experiences of the ancient Eastern massage culture and the modern findings of Western hydrotherapy to create hot tubs providing the perfect massage experience.

Develop a peaceful space for relaxation with your product in your home and join the group of the few who seek a positive impact on their environment by establishing internal harmony.

Dive into your hot tub and enjoy the gently flowing water!

The user manual is available at <http://www.wellis.com/catalogue>.

Aeware®, Gecko®, and their respective logos are Registered Trademarks of Gecko Alliance Group. in.yt™, in.ye™, in.yj™, in.touch™, in.stream 2™, DJS™, in.k110™, in.k120™, in.k361™, in.k1001™, in.clear™, and their respective logos are Trademarks of Gecko Alliance Group.

All other product or company names that may be mentioned in this publication are tradenames, trademarks or registered trademarks of their respective owners.

IMPORTANT SAFETY INSTRUCTIONS

1. **READ AND FOLLOW ALL INSTRUCTIONS.**
2. **WARNING** – To reduce the risk of injury, do not permit children to use this product unless they are closely supervised at all times.
3. A wire connector is provided on this unit to connect a minimum 8 AWG (8.4 mm²) solid copper conductor between this unit and any metal equipment, metal enclosures of electrical equipment, metal water pipe, or conduit within 5 feet (1.5 m) of the unit.
4. (For cord-connected/convertible units) **DANGER** – Risk of injury.
 - a) Replace damaged cord immediately.
 - b) Do not bury cord.
 - c) Connect to a grounded, grounding type receptacle only.
5. **DANGER** – Risk of Accidental Drowning. Extreme caution must be exercised to prevent unauthorized access by children. To avoid accidents, ensure that children cannot use this hot tub unless they are supervised at all times.
6. **DANGER** – Risk of Injury. The suction fittings in this hot tub are sized to match the specific water flow created by the pump. Should the need arise to replace the suction fittings or the pump, be sure that the flow rates are compatible.
Never operate hot tub if the suction fittings are broken or missing. Never replace a suction fitting with one rated less than the flow rate marked on the original suction fitting.
7. **DANGER** – Risk of Electric Shock. Install at least 5 feet (1.5 m) from all metal surfaces. As an alternative, a hot tub may be installed within 5 feet of metal surfaces if each metal surface is permanently connected by a minimum 8 AWG (8.4 mm²) solid copper conductor to the wire connector on the terminal box that is provided for this purpose.
8. **DANGER** – Risk of Electric Shock. Do not permit any electric appliance, such as a light, telephone, radio, or television, within 5 feet (1.5 m) of a hot tub.
9. **WARNING** – To reduce the risk of injury:
 - a) The water in a hot tub should never exceed 40°C (104°F). Water temperatures between 38°C (100°F) and 40°C are considered safe for a healthy adult. Lower water temperatures are recommended for young children and when hot tub use exceeds 10 minutes.
 - b) Since excessive water temperatures have a high potential for causing fetal damage during the early months of pregnancy, pregnant or possibly pregnant women should limit hot tub water temperatures to 38°C (100°F).
 - c) Before entering a hot tub, the user should measure the water temperature since the tolerance of water temperature-regulating devices varies.
 - d) The use of alcohol, drugs, or medication before or during hot tub use may lead to unconsciousness with the possibility of drowning.
 - e) Obese persons and persons with a history of heart disease, low or high blood pressure, circulatory system problems, or diabetes should consult a physician before using a hot tub.
 - f) Persons using medication should consult a physician before using a hot tub since some medication may induce drowsiness while other medication may affect heart rate, blood pressure, and circulation.

13. SAVE THESE INSTRUCTIONS.

Audio/video components

- a) "CAUTION – Risk of Electric Shock. Do not leave compartment door open";
- b) "CAUTION – Risk of Electric Shock. Replace components only with identical components"; and
- c) "Do not operate the audio/video controls while inside in the hot tub".
- d) "WARNING – Prevent Electrocutation. Do not connect any auxiliary components (for example cable, additional speakers, headphones, additional audio/video components, etc.) to the system".
- e) These units are not provided with an outdoor antennae; when provided, it should be installed in accordance with Article 810 of the National Electrical Code, ANSI/NFPA 70.
- f) Do not service this product yourself as opening or removing covers may expose you to dangerous voltage or other risk of injury. Refer all servicing to qualified service personnel.
- g) When the power supply connections or power supply cord(s) are damaged; if water is entering the audio/video compartment or any electrical equipment compartment area; if the protective shields or barriers are showing signs of deterioration; or if there are signs of other potential damage to the unit, turn off the unit and refer servicing to a qualified service personnel.
- h) This unit should be subjected to periodic routine maintenance (for example, once every 3 months) to make sure that the unit is operating properly.

FOR YOUR SAFETY PLEASE ALWAYS PERFORM THE FOLLOWING PRECAUTIONS. IF YOU DO NOT FOLLOW THE WARNINGS AND INSTRUCTIONS, ITEMS MAY GET DAMAGED, YOU MAY GET INJURED, OR YOU MAY SUFFER FATAL INJURY. IMPROPER INSTALLATION AND OPERATION INVALIDATES THE WARRANTY. AVOIDING THE RISK TO CHILDREN

- To reduce the risk of injury, lower water temperatures are recommended for young children. Children are especially sensitive to hot water.
- Extreme caution must be exercised to prevent unauthorized access by children. To avoid accidents, ensure that children cannot use a hot tub unless they are supervised at all times.

DO:

- Make sure you always lock the child resistant locks after using the hot tub for your children's safety.
- Test the water temperature with your hand before allowing children to enter the hot tub to be sure that it's comfortable. Children are especially sensitive to hot water.
- Remind children that wet surfaces can be very slippery. Make sure that children are careful when entering or exiting the hot tub.
- Do not allow children to climb onto the hot tub cover.
- Do not allow children to have unsupervised access to the hot tub.

SAFETY INSTRUCTIONS

AVOIDING THE RISK OF ELECTROCUTION



DANGER - RISK OF ELECTROCUTION

Initial safety warnings

- The hot tub must be powered through a residual current device (rCD) with a current release not exceeding 30mA.
- The devices and parts which contain active parts – except those which are powered from protective extralow voltage not exceeding 12V – must be inaccessible from the hot tub.
- Connect only to a grounded source.
- Do not bury the power cord. A buried power cord may result in death, or serious personal injury due to electrocution if direct burial-type cable is not used, or if improper digging occurs.



WARNING

- To reduce the risk of electrical shock, replace a damaged cord immediately. Failure to do so may result in death or serious personal injury due to electrocution.
- Your hot tub must be connected to a Ground Fault Circuit Interrupter (GFCI) for user and equipment protection. To ensure proper operation of this important safety device, test according to the following instructions per electrical configuration.
- **Cord-Connected 115 volt, 20 amp models:** The GFCI is located at the end of the power cord. Before each use, with the unit operating, push the TEST button. The unit should stop operating and the GFCI power indicator will go out. Wait 30 seconds and then reset the GFCI by pushing the RESET button. The GFCI power indicator will turn on, restoring power to the hot tub. If the interrupter does not perform in this manner, there

may be an electrical malfunction and with it, the possibility of an electric shock. Disconnect the power until the problem has been corrected.

- **2x120 volt, permanently connected or converted models:**
- A ground terminal is provided on the terminal block (TB-1, system ground terminal) located inside the control box. To reduce the risk of electric shock, connect this terminal to the grounding terminal of your electrical service or supply panel with a continuous green, insulated copper wire. The wire must be equivalent in size to the circuit conductors supplying the equipment. In addition, a bonding terminal (pressure wire connector) is provided on the outside of the control box for bonding to local ground points. To reduce the risk of electric shock, this connector should be bonded with a No. 8 AWG (8.4 mm²) solid copper wire to any metal ladders, water pipes, or other metal within 5 feet (1.5 m) of the hot tub to comply with local requirements. The means of disconnection must be readily accessible, but must be installed at least 5 feet (1.5 m) from the hot tub.
- Your hot tub is provided with a suitably rated circuit breaker to open all ungrounded supply conductors.
- Your hot tub uses ground fault circuit interrupters in the electrical subpanel. Before each use of the hot tub and with the unit operating, push the TEST button on each breaker. The switch should click over to the “Trip” position. Wait 30 seconds and reset each GFCI breaker by switching it completely off and then completely on.

The switch should then stay on. If either of the interrupters does not perform in this manner, it is an indication of an electrical malfunction and the possibility of an electric shock. Disconnect the power until the fault has been identified and corrected.

SAFETY INSTRUCTIONS

IMPORTANT: Failure to wait 30 seconds before resetting the GFCI may cause the hot tub's Power Indicator (on the control panel) to blink. If this occurs, repeat the GFCI test procedure.



DANGER - RISK OF ELECTRIC SHOCK

- A wire connector is provided on this unit to connect a minimum 8 AWG (8.4 mm²) solid copper conductor between this unit and any metal equipment, metal enclosures of electrical equipment, metal water pipe, or conduit within 5 feet (1.5 m) of the unit.
- Install at least 5 feet (1.5 m) from all metal surfaces. As an alternative, a hot tub may be installed within 5 feet of metal surfaces if each metal surface is permanently connected by a minimum 8 AWG (8.4 mm²) solid copper conductor to the wire connector on the terminal box that is provided for this purpose.
- Do not permit any electric appliance, such as a light, telephone, radio, or television, within 5 feet (1.5 m) of a hot tub. Failure to maintain a safe distance may result in death, or serious personal injury due to electrocution, if the appliance should fall into the hot tub.
- Install your hot tub in such a way that drainage is away from the electrical compartment and from all electrical components.
- **CAUTION** — Risk of Electric Shock. Do not leave compartment door open
- **CAUTION** — Risk of Electric Shock. Replace components only with identical components
- Do not service this product yourself as opening or removing covers may expose you to dangerous voltage or other risk of injury. Refer all servicing to qualified service personnel.

DO:

- Be sure your hot tub is connected to the power supply correctly - use a licensed electrical contractor.
- Disconnect the hot tub from the power supply before draining the hot tub or servicing the electrical components.
- Test the Ground Fault Circuit Interrupter(s) before each use.
- Do not use the hot tub with the equipment compartment door removed.
- Do not place electrical appliances within 5 feet (1.5m) of the hot tub.
- Do not use an extension cord to connect the hot tub to its power source. The cord may not be properly grounded and the connection is a shock hazard. An extension cord may cause a voltage drop, which will cause overheating of the jet pump motor and motor damage.
- Do not attempt to open the electrical control box. There are no user serviceable parts inside.

RISKS TO AVOID



DANGER - RISK OF INJURY

- To reduce the risk of injury to persons, **DO NOT** remove suction fittings (filter standpipes) located in the filter compartment.
- There is a danger of slipping and falling. Remember that wet surfaces can be very slippery. Take care when entering or exiting the hot tub.
- Never operate hot tub if the suction fittings are broken or missing.
- People with infectious diseases should not use the hot tub.
- Keep any loose articles of clothing, long hair, or hanging jewelry away from rotating jets or other moving components.

SAFETY INSTRUCTIONS

- Water treatment should be carried out with caution. Improperly chemically treated water may cause skin irritation.
- Do not remove any suction sealing.
- Do not operate the hot tub if the suction sealing is broken or missing.



- Warning! The metallic parts of the pool may become hot when exposed to sunlight and can cause injury!
- Keep your clothes and jewellery away from rotating jets and moving parts.
- Effects of overheating: you cannot assess emergency situations, do not feel the temperature, do not feel the need to get out of the hot tub, cannot get out of the hot tub; risk of fetal damage in pregnant women, loss of consciousness, suffocation.
- Do not use the hot tub alone.
- Do not use the hot tub immediately after strenuous sport.

INCREASED SIDE EFFECTS OF MEDICATION

- The use of drugs, alcohol may cause unconsciousness with the possibility of drowning.

HEALTH PROBLEMS AFFECTED BY HOT TUB USE

- Pregnant women should consult a physician before using hot tub.
- Obese persons and persons with a history of heart disease, low or high blood pressure, circulatory system problems, or diabetes should consult a physician before using a hot tub.

AVOIDING THE RISK OF HYPERTHERMIA

Prolonged immersion in hot water can result in HYPERTHERMIA, Hyperthermia occurs when the internal temperature of the body reaches a level several degrees above

the normal body temperature of 98.6°F. The symptoms of hyperthermia include an increase in the internal temperature of the body, dizziness, lethargy, drowsiness, and fainting. The effects of hyperthermia include failure to perceive heat; failure to recognize the need to exit hot tub or hot tub; unawareness of impending hazard; fetal damage in pregnant women; physical inability to exit the hot tub or hot tub; and unconsciousness resulting in the danger of drowning.



WARNING

The use of alcohol, drugs, or medication before or during hot tub use may lead to unconsciousness with the possibility of drowning.

TO REDUCE THE RISK OF INJURY

- The water in a hot tub should never exceed 40°C (104°F). Water temperatures between 38°C (100°F) and 40°C are considered safe for a healthy adult. Lower water temperatures are recommended for young children and when hot tub use exceeds 10 minutes. Extended use can cause hyperthermia.
- Since excessive water temperatures have a high potential for causing fetal damage during the early months of pregnancy, pregnant or possibly pregnant women should limit hot tub water temperatures to 38°C (100°F).
- Pregnant or possibly pregnant women should limit hot tub water temperatures to 100°F (36°C). Failure to do so may result in permanent injury to your baby.
- Do not use hot tub immediately following strenuous exercise.
- Obese persons and persons with a history of heart disease, low or high blood pressure, circulatory system problems, or diabetes should consult a physician before using a hot tub.

SAFETY INSTRUCTIONS

AVOIDING THE RISK OF SKIN BURNS

- Before entering a hot tub, the user should measure the water temperature since the tolerance of water temperature-regulating devices varies.
- To reduce the risk of injury, before entering a hot tub the user should measure the water temperature with an accurate thermometer.
- Test the water with your hand before entering the hot tub to be sure it's comfortable.

PRODUCT SAFETY AND MAINTENANCE

For units intended for use in other than single-family dwellings, a clearly labeled emergency switch must be provided as part of the installation. The switch must be readily accessible to the occupants and must be installed at least 5 feet (1.52 m) away, adjacent to, and within sight of, the unit.

When the hot tub is not in use, cover the hot tub with the cover to prevent ultraviolet radiation causing damage to the product.

Do not remove any suction sealing. Do not operate the hot tub if the suction sealing is broken or missing.

Keep your clothes and jewellery away from rotating jets and moving parts.

Test the residual current device before use.

Disconnect the hot tub from the power supply before servicing its electrical parts. (This operation can only be performed by qualified professionals).

It is strictly prohibited to use the hot tub in a not completely assembled state (e.g. detached side panel)

Chemical treatment of water can only be performed by persons under the age of 18 under parental supervision.

Maintenance can only be performed by trained professionals.

The user should check the electrical wiring every 3 months. It is required to perform a check by a professional every 3 years.

Mains fuses / circuit breakers may be activated because of power outages.

Installation and wiring of the hot tub, replacement of power cord, and any repairs must be performed by qualified profession- als.

It is required to build in an isolating device to the fixed wiring.

PLUG'N'PLAY SAFETY WARNINGS BEYOND THE PREVIOUS WARNINGS, PLEASE ALSO PAY ATTENTION TO THE UNDERMENTIONED ONES.

***ATTENTION!** The electrical receptacle must be located at least 2.5 meters from the hot tub so that bathers in a sitting position cannot reach it from the water. The plug can only be connected to a receptacle equipped with 2.5mm 2 diameter cables.*

***ATTENTION! RISK OF ELECTRIC SHOCK.** The connector with residual current device must be inspected before every use.*

***ATTENTION!** Only place the RCD plug in a receptacle equipped with RCD.*

***ATTENTION!** Before you insert the plug into the socket ensure that the current of the socket and the fixed wiring is appropriate for the properties of the hot tub.*

The hot tub must be equipped with an isolation transformer or powered through a residual current device with a release current not exceeding 30mA.

This product is equipped with a ground fault circuit breaker (GFCI) in the connector. GFCI must be tested before each use.

If the power cable is damaged, it must immediately be re- placed by the manufacturer or a service professional in order to minimize danger.

SAFETY INSTRUCTIONS

To minimize the risk of electric shock do not use extension leads to connect the product to the power supply.

Ensure that the receptacle is properly located.

Parts of the equipment cannot be placed above the hot tub during usage.

Parts under electrical power – except those operating with voltage not exceeding 12V - must be inaccessible for persons in the hot tub. The grounded device must be connected to a fixed socket with fixed wiring. Electrical parts – except remote controllers – must be positioned so as not to fall into the hot tub.

The electrical installation must meet the local standard requirements.

To avoid electric shock do not use the hot tub in rain.

Water attracts children. Always place and lock the cover on the hot tub after each usage.

Do not bury cables into the ground! Place the cables so that lawnmowers, trimmers, and similar devices will not reach them.

Do not force push the control panel up nor down and do not place heavy objects on it after installation.

Keep pets away from the hot tub to avoid damage.

Do not use the device if there is the slightest chance of water in the hot tub being frozen.

Only use accessories approved by us. The use of accessories not approved by us may void the warranty.

Choking hazard. Particular attention need to be paid to children during usage. To avoid accidents only allow children to use this hot tub under adult supervision.

To prevent damage to the pump the hot tub can only be operated if it has been filled with water.

If you feel uncomfortably or sleepy, leave the hot tub immediately.

Never add water to the chemicals. Always be cautious when adding chemicals to the hot tub water to avoid inhaling vapors and possible effects of inhaling undiluted chemicals and splatters.

Only place the hot tub on a surface that can support its weight.

Inspect the unit before use. contact the service provider stated in this manual if any of the parts were damaged or missing upon purchase. Ensure that the parts of the unit are those which you intended to buy.

In.clear safety warnings

Beyond the previous warnings, please also pay attention to the undermentioned ones read this manual carefully, always follow its instructions, and retain it. This manual contains important information about the installation, operation, and safety recommendations of the in.clear unit. Safe installation and usage is your responsibility.

The in.clear unit must be connected to a network protected by a ground fault circuit interrupter (GFCI) of the maximal nominal fault current value of 30mA.

Ensure that the entire power supply is turned off before the in.clear unit is installed.

If the power cord is damaged, it must be replaced by the manufacturer, an authorized service provider, or qualified professionals to avoid emergencies.

Always use a proper electric cable for supply of current to the in.clear unit.

When installing the in.clear Automatic Bromine Generator local and international electrical regulations must be complied with.

Clean or replace the filter cartridge at regular intervals, otherwise part of the bromine produced by the in.clear unit will be consumed by oxidation of contamination accumulated in the filter.

DO NOT pour any other chemicals into the hot tub than the recommended sodium bromide.
DO NOT use any ozone or UV disinfectant.

Operating the in.clear unit on lower sodium bromide level shortens the life of the cells. Keeping sodium bromide and bromine levels above the recommended level may lead to corrosion of the hot tub components and cause damage to the hot tub accessories.

Do not open the in.clear unit; it does not contain serviceable parts

Product disposal: the in.clear unit must be disposed of in accordance with local disposal regulations in force.

This device is not intended for use by persons (nor children) with limited physical, sensory, or mental capabilities except if these persons have received appropriate instruction on use of the device from the person responsible for their safety.

The in.clear unit cannot be applied to in-ground sunken hot tubs as it may affect materials used in the construction.

The shut-off device must have fixed wiring in accordance with the cabling regulations.

Showering is compulsory before each hot tub use.

The user is responsible for regular monitoring of the hot tub water to ensure that enough bromine is available to reach the appropriate cleaning level. Intensive hot tub use may require higher bromine intake to always maintain appropriate bromine level.

Always check the expiry date of the test kit, because after this date the test results may be inaccurate.

For proper disinfection hot tubs must periodically be completely drained. The advised time period between full drains given in days is calculated by dividing the capacity of the hot tub in litres by the tenfold of the average daily users.

The in.clear unit is applicable for indoor hot tubs, but NOT for swimming pools.

THIS UNIT SHOULD BE SUBJECTED TO PERIODIC ROUTINE MAINTENANCE (FOR EXAMPLE, ONCE EVERY 3 MONTHS) TO MAKE SURE THAT THE UNIT IS OPERATING PROPERLY.

SAVE THESE INSTRUCTIONS

WARNING: CHILDREN SHOULD NOT USE HOT TUBS OR HOT TUBS WITHOUT ADULT SUPERVISION

AVERTISSEMENT : NE PAS LAISSER LES ENFANTS UTILISER UNE CUVE DE RELAXATION SANS SURVEILLANCE

WARNING: DO NOT USE HOT TUBS OR HOT TUBS UNLESS ALL SUCTION GUARDS ARE INSTALLED TO PREVENT BODY AND HAIR ENTRAPMENT

AVERTISSEMENT : POUR ÉVITER QUE LES CHEVEUX OU UNE PARTIE DU CORPS PUISSENT ÊTRE ASPIRÉS, NE PAS UTILISER UNE CUVE DE RELAXATION SI LES GRILLES DE PRISE D'ASPIRATION NE SONT PAS TOUTES EN PLACE

WARNING: PEOPLE USING MEDICATIONS AND/OR HAVING AN ADVERSE MEDICAL HISTORY SHOULD CONSULT A PHYSICIAN BEFORE USING A HOT TUB OR HOT TUB

AVERTISSEMENT : LES PERSONNES QUI PRENNENT DES MÉDICAMENTS ET (OU) ONT DES PROBLÈMES DE SANTÉ DEVRAIENT CONSULTER UN MÉDECIN AVANT D'UTILISER UNE CUVE DE RELAXATION

WARNING: PEOPLE WITH INFECTIOUS DISEASES SHOULD NOT USE A HOT TUB OR HOT TUB

AVERTISSEMENT : LES PERSONNES ATTEINTES DE MALADIES INFEC-

SAFETY INSTRUCTIONS - CANADA

TIEUSES NE DEVRAIENT PAS UTILISER UNE CUVE DE RELAXATION

WARNING: TO AVOID INJURY, EXERCISE CARE WHEN ENTERING OR EXITING THE HOT TUB OR HOT TUB

AVERTISSEMENT : POUR ÉVITER DES BLESSURES, USER DE PRUDENCE EN ENTRANT DANS UNE CUVE DE RELAXATION ET EN SORTANT

WARNING: DO NOT USE DRUGS OR ALCOHOL BEFORE OR DURING THE USE OF A HOT TUB OR HOT TUB TO AVOID UNCONSCIOUSNESS AND POSSIBLE DROWNING

AVERTISSEMENT : POUR ÉVITER L'ÉVANOUISSEMENT ET LA NOYADE ÉVENTUELLE, NE PRENDRE NI DROGUE NI ALCOOL AVANT D'UTILISER UNE CUVE DE RELAXATION NI QUAND ON S'Y TROUVE

WARNING: PREGNANT OR POSSIBLY PREGNANT WOMEN SHOULD CONSULT A PHYSICIAN BEFORE USING A HOT TUB OR HOT TUB

AVERTISSEMENT : LES FEMMES ENCEINTES, QUE LEUR GROSSESSE SOIT CONFIRMÉE OU NON, DEVRAIENT CONSULTER UN MÉDECIN AVANT D'UTILISER UNE CUVE DE RELAXATION

WARNING: WATER TEMPERATURE IN EXCESS OF 38 °C CAN BE INJURIOUS TO YOUR HEALTH

AVERTISSEMENT : IL PEUT ÊTRE DANGEREUX POUR LA SANTÉ DE SE PLONGER DANS DE L'EAU À PLUS DE 38 °C

WARNING: BEFORE ENTERING THE HOT TUB OR HOT TUB, MEASURE THE WATER TEMPERATURE WITH AN ACCURATE THERMOMETER

AVERTISSEMENT : AVANT D'UTILISER UNE CUVE DE RELAXATION, MESURER LA TEMPÉRATURE

DE L'EAU À L'AIDE D'UN THERMOMÈTRE PRÉCIS

WARNING: DO NOT USE A HOT TUB OR HOT TUB IMMEDIATELY FOLLOWING STRENUOUS EXERCISE

AVERTISSEMENT : NE PAS UTILISER UNE CUVE DE RELAXATION IMMÉDIATEMENT APRÈS UN EXERCICE FATIGANT

WARNING: PROLONGED IMMERSION IN A HOT TUB OR HOT TUB CAN BE INJURIOUS TO YOUR HEALTH

AVERTISSEMENT : L'UTILISATION PROLONGÉE D'UNE CUVE DE RELAXATION PEUT ÊTRE DANGEREUSE POUR LA SANTÉ

WARNING: DO NOT PERMIT ELECTRIC APPLIANCES (SUCH AS A LIGHT, TELEPHONE, RADIO, OR TELEVISION) WITHIN 1.5 M OF THIS SPA OR HOT TUB

AVERTISSEMENT : NE PAS PLACER D'APPAREIL ÉLECTRIQUE (LUMINAIRE, TÉLÉPHONE, RADIO, TÉLÉVISEUR, ETC) À MOINS DE 1.5 M DE CETTE CUVE DE RELAXATION

CAUTION : MAINTAIN WATER CHEMISTRY IN ACCORDANCE WITH MANUFACTURER'S INSTRUCTIONS

ATTENTION: LA TENEUR DE L'EAU EN MATIÈRES DISSOUTES DOIT ÊTRE CONFORME AUX DIRECTIVES DU FABRICANT.

WARNING: THE USE OF ALCOHOL OR DRUGS CAN GREATLY INCREASE THE RISK OF FATAL HYPERTHERMIA IN HOT TUBS AND SPAS

LA CONSOMMATION D'ALCOOL OU DE DROGUE AUGMENTE CONSIDÉRABLEMENT LES RISQUES D'HYPERTHERMIE MORTELLE DANS UNE CUVE DE RELAXATION.

SAFETY INSTRUCTIONS - CANADA

WARNING: RISK OF ACCIDENTAL DROWNING. EXTREME CAUTION MUST BE EXERCISED TO PREVENT UNAUTHORIZED ACCESS. ENSURE THAT CHILDREN CANNOT USE THIS PRODUCT UNLESS THEY ARE SUPERVISED AT ALL TIMES

AVERTISSEMENT : RISQUE DE NOYADE. PRENDRE TOUTES LES PRÉCAUTIONS NÉCESSAIRES POUR INTERDIRE L'ACCÈS AUX PERSONNES NON AUTORISÉES. S'ASSURER QUE LES ENFANTS NE PUISSENT PAS UTILISER CE PRODUIT SANS SURVEILLANCE CONSTANTE

WARNING: RISK OF ACCIDENTAL DROWNING. THE USE OF ALCOHOLIC BEVERAGES OR DRUGS BEFORE OR DURING SPA USE CAN LEAD TO UNCONSCIOUSNESS WITH THE POSSIBILITY OF DROWNING

AVERTISSEMENT : RISQUE DE NOYADE. TOUTE PERSONNE QUI PREND DE LA DROGUE OU DE L'ALCOOL AVANT D'UTILISER UNE CUVE DE RELAXATION OU PENDANT QU'ELLE S'Y TROUVE RISQUE L'ÉVAUOUISSMENT ET LA NOYADE

WARNING: RISK OF ACCIDENTAL DROWNING DUE TO HYPERTHER-

MIA. CONSULT THE INSTRUCTIONS PROVIDED WITH THIS UNIT FOR A DESCRIPTION OF THE CAUSES, SYMPTOMS, AND EFFECTS OF HYPERTHERMIA

AVERTISSEMENT : RISQUE DE NOYADE PAR SUITE D'HYPERTHERMIE. LIRE LA NOTICE QUI ACCOMPAGNE

CET APPAREIL; ELLE DÉCRIT LES CAUSES, LES SYMPTÔMES ET LES EFFETS DE L'HYPERTHERMIE

WARNING: RISK OF ELECTRIC SHOCK. DO NOT PERMIT ANY ELECTRIC APPLIANCE (SUCH AS A LIGHT, TELEPHONE, RADIO, OR TELEVISION) WITHIN 1.5 M OF A SPA

AVERTISSEMENT : DANGER D'ÉLECTROCUTION. NE PAS PLACER D'APPAREIL ÉLECTRIQUE (LUMIÉRE, TÉLÉPHONE, RADIO, TÉLÉVISEUR, ETC) À MOINS DE 1.5 M DE CETTE CUVE DE RELAXATION

WARNING: THIS MARKING SHALL BE REMOVED BY THE END USER OF THIS PRODUCT ONLY

AVERTISSEMENT : SEUL L'UTILISATEUR DE CE PRODUIT PEUT ENLEVER CE MARQUAGE.

IMPORTANT SAFETY INSTRUCTIONS

When using this electrical equipment, basic safety precautions should always be followed, including the following:

A) **READ AND FOLLOW ALL INSTRUCTIONS.**

B) A GREEN COLOURED TERMINAL OR A TERMINAL MARKED G, GR, GROUND, GROUNDING, OR THE Ⓧ SYMBOL IS LOCATED INSIDE THE SUPPLY TERMINAL BOX OR COMPARTMENT. TO REDUCE THE RISK OF ELECTRIC SHOCK, THIS TERMINAL MUST BE CONNECTED TO THE GROUNDING MEANS PROVIDED IN THE ELECTRIC SUPPLY SERVICE PANEL WITH A CONTINUOUS COPPER WIRE EQUIVALENT IN SIZE TO THE CIRCUIT CONDUCTORS SUPPLYING THIS EQUIPMENT.

C) AT LEAST TWO LUGS MARKED “BONDING LUGS” ARE PROVIDED ON THE EXTERNAL SURFACE OR ON THE INSIDE OF THE SUPPLY TERMINAL BOX OR COMPARTMENT. TO REDUCE THE RISK OF ELECTRIC SHOCK, CONNECT THE LOCAL COMMON BONDING GRID IN THE AREA OF THE HOT TUB OR SPA TO THESE TERMINALS WITH AN INSULATED OR BARE COPPER CONDUCTOR NOT SMALLER THAN NO. 6 AWG.

D) ALL FIELD-INSTALLED METAL COMPONENTS SUCH AS RAILS, LADDERS, DRAINS, OR OTHER SIMILAR HARDWARE WITHIN 3 M OF THE SPA OR HOT TUB SHALL BE BONDED TO THE EQUIPMENT GROUNDING BUS WITH COPPER CONDUCTORS NOT SMALLER THAN NO. 6 AWG.

E) **SAVE THESE INSTRUCTIONS.**

INITIAL INSTALLATION

Electrical preparations:

A clearly labeled emergency switch shall be provided as part of the installation. The switch shall be readily accessible to the occupants and shall be installed at least 5 feet (1.52 m) away, adjacent to, and within sight of, the unit.

Before installation the hot tub, the electrical system has to be prepared, as detailed in the below table.

Item number	Spa name	Requirements	Heater (w)	Water quantity (gallons)	Dry weight (Lbs)	Filled weight (Lbs)	Dead weight (Lbs)	Dimensions		High	Filter (sqf)
WM00570	MONT BLANC	240V / 48A / 60Hz / 60A Breaker	4000	397	816	4127	58	91 "	91 "	38 "	3x30
WM00571	MONTE ROSA	240V / 48A / 60Hz / 60A Breaker	4000	397	854	4165	58	91 "	91 "	38 "	3x30
WM00573	LONDON Deluxe	240V / 37A / 60Hz / 50A Breaker	4000	291	728	3155	52	86 "	86 "	36 "	1x50
WM00574	PARIS DELUXE	240V / 37A / 60Hz / 50A Breaker	4000	291	662	3089	52	86 "	86 "	36 "	1x50
WM00711	LEO P&P	120V / 12A / 60Hz / 15A Breaker	1000	185	486	2029	45	85 "	75 "	34 "	1x30
WM00713	HERCULES	240V / 35A / 60Hz / 50A Breaker	4000	238	618	2603	51	85 "	85 "	36 "	1x50
WM00715	LEO Scandi Pack	230V / 28A / 60Hz / 40A Breaker	4000	185	486	2029	45	85 "	75 "	34 "	1x30
WM00717	TAURUS	240V / 37A / 60Hz / 50A Breaker	4000	397	854	4165	58	91 "	91 "	38 "	3x30
WM00740	LIBRA	240V / 37A / 60Hz / 50A Breaker	4000	397	499	3810	58	91 "	91 "	36 "	3x30
WM00710	ORION P&P	120V / 12A / 60Hz / 15A Breaker	1000	133	375	1485	33	79 "	60 "	31 "	1x30

BASIC FUNCTIONS

Keypads: The keypads make it possible to control and set up the spa. Available basic functions: pump(s), light and temperature control. (For more information see the details later)

Valves

Diverter: Some spa are equipped with water diverter(s) that allows you to direct the waterflow to various sections of the spa. The valve has three basic positions By turning the lever all the way to the left position will divert the water section A of the spa. By turning the lever all the way to the right will shut off section A and divert the water to section B and by moving the lever to the middle between A & B will divert the water to both A & B sections

Waterfall diverter: Some spas are equipped with a waterfall diverter which will turn the waterfalls/fountains either on or off

Air regulators: You can use it by turning the lever counter-clockwise, will open the Air Regulator to allow air to mix with the water to create more pressure from the jets. Turning the lever to the left will close the valve not allowing air to mix with the water for the jets. These air regulators should remain closed when the spa is not in use to save energy.

Speakers (Optional): If your spa is equipped with an audio system, you can connect via Bluetooth and help your relaxing with your favourite music. (MyMusic pin:2288)

Filter house: Part of the recirculating system, it holds the paper filter.

Fountain: Some spas are equipped with fountains or waterfalls. If you open the waterfall diverter, the water will flow through the fountains or waterfalls.

Jets: There are 3 sizes of jets; the 5" and 3" jets have two types: directional and rotational. The 2" jets are only directional. To open the jet face is turned clockwise. To lessen the pressure or to close, the jet face is turned counter-clockwise

Aroma therapy: You can stimulate your senses with different aromas. You can get aroma into the water if you push the button on the top of the tank. you can block the button if you turn it.

Suction: The pumps suck the water through this element. Never block it, and keep your body and hair away from these units.

Head rests



Keypads



Diverter, Air regulator, On/off valve



Speakers



Filter house



Fountain



Jet (5"-direct, rotational; 3"-direct, rotational; 2"-direct)



Aroma



Suction



INITIAL INSTALLATION

SITE PREPARATION

When choosing a site for the hot tub take into account that its maintenance and repair works must be carried out behind the sidewalls, so accessibility and hot tubce to walk around the hot tub must be ensured.

1. INDOOR/BASEMENT INSTALLATION

If you place your hot tub indoors, be aware of some special requirements:

Water may accumulate around the hot tub, so the flooring material must have a proper runoff to avoid accumulation of water. When building a new room for the hot tub, constructing a floor drain is required, or damages may occur due to overflow, overfilling, or technical failure. Our company does not take responsibility for any damage in absence of floor drainage. Humidity will naturally increase in the room where the hot tub is located and the evaporated water condenses. For this reason ensure that the area has proper ventilation. We recommend installing a dehumidifier in the room.

2. OUTDOOR AND PATIO INSTALLATION

A solid horizontal foundation is necessary for installation of the hot tub. We advise using a reinforced concrete foundation at least 10-15cm thick. Do not shim the spa, it may casue not repairable damages. The base to be even and horizontal.



Ensure that your deck or foundation will support your hot tub. You must know the maximal load capacity of the foundation. Consult a qualified building contractor or structural engineer.

To find out the weight of your hot tub, its contents and occupants please refer to the hot tub specification chart. This weight must not exceed the structure's rated capacity per square meter, otherwise serious structural damages could result. If you install the hot tub outdoors, we recommend a reinforced horizontal concrete pad at least 10-15cm thick.

Install floor drains around your hot tub to lead water away even in heavy rain.

When constructing the water drain it is advised to form a 10-15cm deep sloping ditch around the hot tub which directs water to the drain. Water from the drain must be directed to the canal or a drainage with enough capacity.

Warning: Do not expose the hot tub to direct sunlight (not even empty) without proper coverage. The insulated hot tub cover preserves the water temperature and provides protection from sunlight and rain. When exposed to sunshine for a longer period it may damage the surface of the hot tub and the hot tub equipment.

Acrylic rapidly absorbs heat from sun rays, thus reaches a very high surface temperature which may damage the hot tub.

In case of sealed design, if the hot tub was placed between glass structures, prevent the sun rays from reaching the hot tub directly through the glass as the temperature may get too high.

3. IN-GROUND / SUNKEN HOT TUB

In case of sinking the hot tub into the ground you must make sufficient space for walking around the hot tub. For completion of maintenance works a minimum of 60cm wide inspection pit must be built around the hot tub.

The inspection pit's bottom must be under the bearing point of the hot tub so that water can flow into the pit in case of water leakage. A floor drain or sump pump should be used at the bottom of the pit to ensure continual water drainage.

In case of sinking the hot tub only the portion below the hot tub's acrylic edge can be sunk. The air of the inspection pit steams up. To prevent unpleasant odors proper ventilation must be provided (e.g. installing ventilators). The costs of pulling the hot tub out of the ground are borne by the user. If the aforementioned conditions are not present, setting up the hot tub may fail.

First filling of the hot tub

Proper filling of the hot tub is an important task both technically and chemically. We advise installation and periodic maintenance by the servicing professionals, which includes inspection and refilling of hot tub water. Hot tubs do not contain water softener and hard water damages the equipment. Improper filling of the hot tub may bring air into the system, which damages the heating wire and engines. Repairs after such failures are not covered by warranty.

INITIAL INSTALLATION

Filling process

Remove the hot tub cover. First remove the cover staves, then remove the side covers by unscrewing the bottom screws. During transportation the flare fittings of engines may dislocate. Check these connections before installation. If necessary, tighten the flare fittings.

Before filling the hot tub check that the Slice valves are not in a closed state (lever is pulled out and fixed with the safety lock).

Next fill the hot tub with water to the sign indicated on its sidewall.

Filling must be done through the filter housing. Improper filling can damage the engines and heating element.

Insert the filter or filter cartridges when proper water level is reached. Be cautious, because when replacing the filter cartridge air bubbles may remain in the cartridge. To avoid this the filter cartridges must be tilted in the water to remove air from them, and only then fitted to their place.



MAJOR COMPONENTS OF THE PRODUCT

OLYMPUS

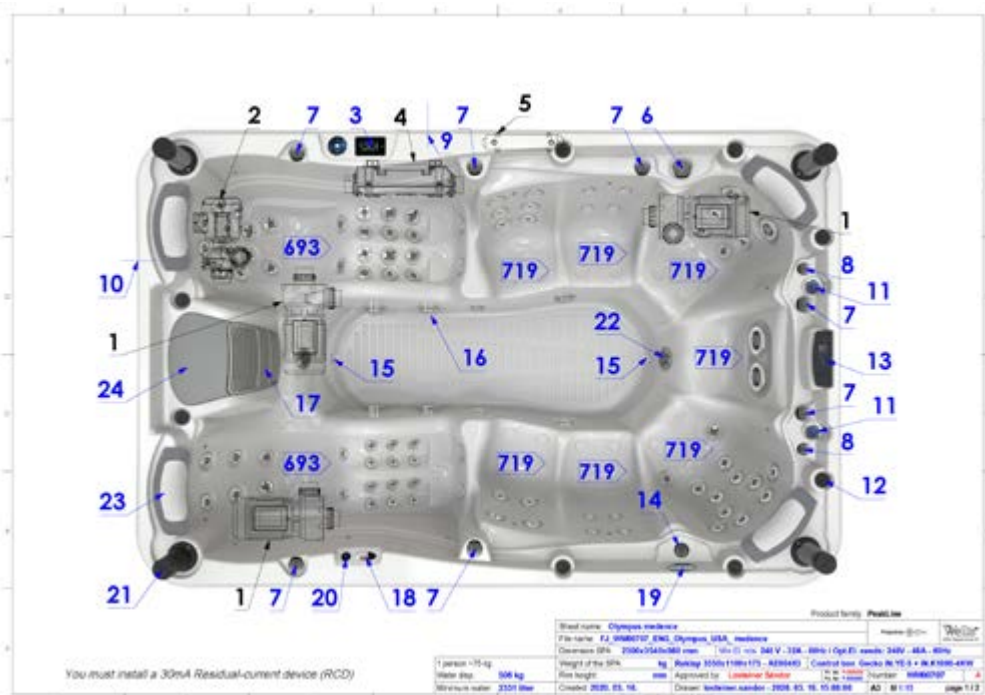

Number	Product code	Product name	PC
1.	ACM0734	Spa Pump 3 HP - One Speed	3
2.	ACM0881	Gecko CMMP circulation pump 190W	1
3.	ACM0768	Control Panel - IN K1000	1
4.	ACM0726	Control BOX - IN YE-S	1
	ACM0926	Heater 4KW	1
5.	ACM0888	UV-C Stainless steel house set	1
6.	AKU1894	Water Diverter - Grip Wells V2	1
7.	AKU1895	Air regulator grip Wells V2	7
8.	AKU1896	On-off tap grip Wells V2	2
9.		Electrical connection	1
10.		Drain position	1
11.	AKU0044	Water Pop-Up fountain	2
12.	AKU0056	Cup Holder Light lens	8
13.	AKU1834	Waterfall 225x51x8	1
14.	AM00744	Pump type aromatherapy house	1
15.	AJ00169	Jet - 20 50 - Ozone 90°	2
16.	AKU0064	Suction - 73.5 / 60.3.5 - Thick	6
17.	AKU0090	Filter House - Skimmer Cover II light grey	1
18.	ACM0766	Control Panel - Pulsar / sequencer	1
19.	ACM0782	Control Panel - AUK Four Button	1
20.	ACM0763	Control Panel - AUK One Button	1
21.	ACM0521	Speaker - Round Pop-Up	4
	ACM0849	Subwoofer 288 W	1
	ACM0695	Speaker Cable - 2 x 0.75 RED-BLACK	25
	ACM0769	Amplifier - InStream 2	1
22.	ACM0803	Underwater light - RGB (7 leds)	2
23.	AF00060	Pillow 420x180x75 (RGB) Wells two colours	4
24.	AKU0059	Filter House - Skimmer Cover II light grey	1
25.	AKU0047	Filter House - 60.3.5 x 60.3.5 - Skimmer	1
26.	AKU0116	Spa Filter - 235 x 127 - Wells Antimicrobial blue (no thread)	1

Product code	Jets	PC
AJ00217	Jet 3" - transparent 1 Hole rotational transparent V3 Wells	28
AJ00216	Jet 3" - transparent 1 Hole transparent V3 Wells	34
AJ00214	Jet 2" - transparent 1 Hole transparent V3 Wells	22
AJ00218	Jet 5" - transparent 1 Hole transparent V3 Wells	2
AJ00186	Jet swirmapa-oval	2
AJ002305ET	5" jet body V3 transparent set	2
AJ0022964T	9" jet body V3 transparent set	62
AJ002265ET	2" jet body V3 transparent set	24
AJ00184	Jet Swim chrome plated	2

You must install a 30mA Residual-current device (RCD)

MAJOR COMPONENTS OF THE PRODUCT

MONT BLANC (ELBRUS 230)

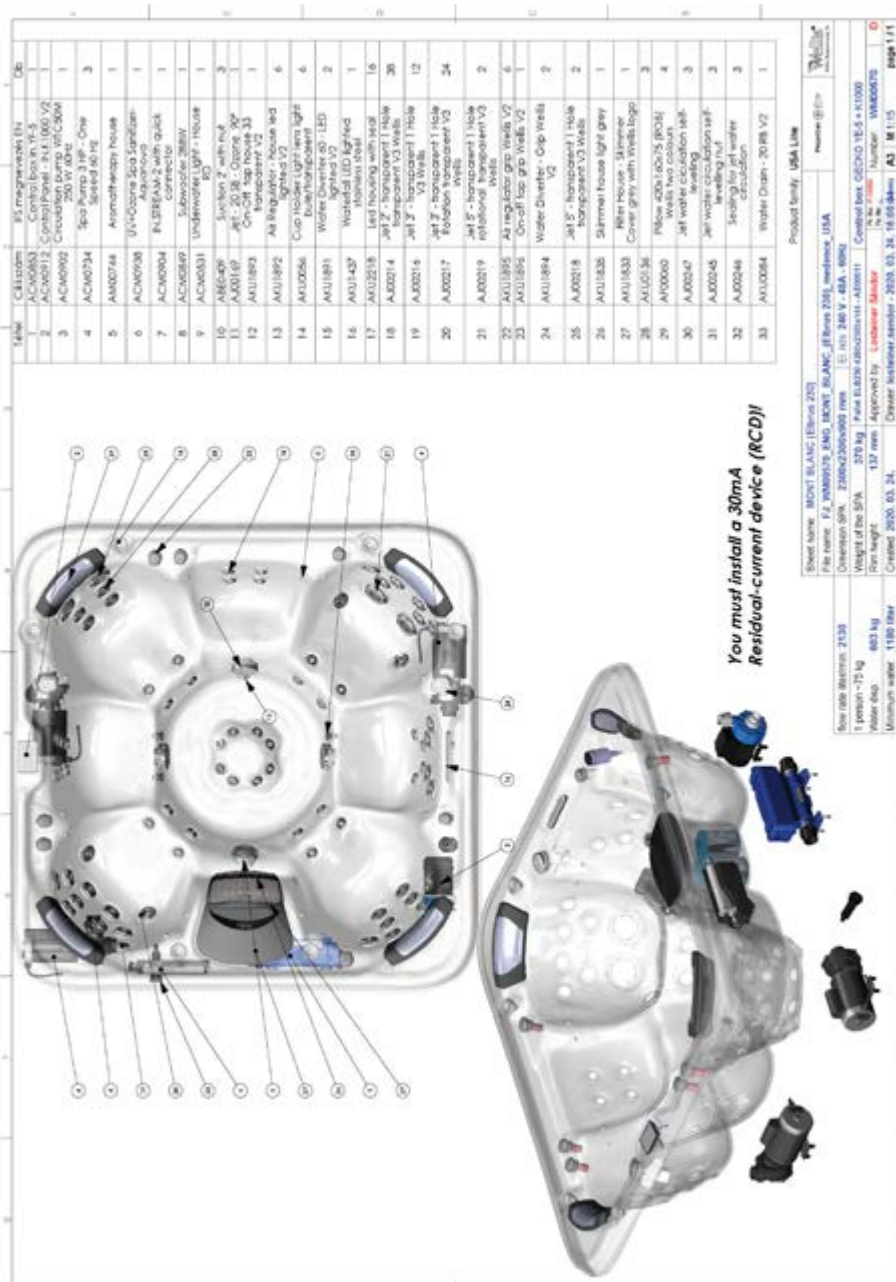

You must install a 30mA Residual-current device (RCD)

Label	Call item	It's megaword B1	DB
1	ACM0053	Control box n. 14-3	
2	ACM0012	Control Panel - 1x1, 1000 V2	
3	ACM0092	Control Panel - 1x1, 1000 V2	
4	ACM0092	Control Panel - 1x1, 1000 V2	
5	ACM0034	Spa Pump 3 HP - One Speed 60 Hz	3
6	AM00744	Atomotherapy House	
7	ACM0008	UV/Ozone Spa Sanitizer Appliance	1
8	ACM0004	IN-BREAM-2 with quick connector	1
9	ACM0049	Submersible pump	1
10	ACM0031	Underwater Light - House RO	1
11	AB0049	Switch 2 with n.c.	3
12	AKU1892	Jet 20.8 - Ozone 30" - 1.3	3
13	AKU1892	AK Regulator - House led lights V2	6
14	AKU0056	Cup (cylinder) light fixture	6
15	AKU1891	Water Diverter 60 - LED lighted V2	2
16	AKU1437	Waterfall LED lighted	1
17	AKU3238	LED housing with ball	16
18	AJ00214	Jet 2 - nonadjustable foam transparent V3 wells	36
19	AJ00215	Jet 2 - nonadjustable foam transparent V3 wells	12
20	AJ00217	Jet 2 - nonadjustable foam transparent V2	24
21	AJ00219	Jet 2 - nonadjustable foam transparent V3	2
22	AJ01895	Air regulator grip wells V2	6
23	AJ01895	On-air top grip wells V2	1
24	AJ01894	Water Diverter - Grip Wells V2	2
25	AJ00218	Jet 2 - nonadjustable foam transparent V3 wells	2
26	AKU1838	Slammer house light grey	1
27	AJ01833	Riser House - Slammer Cover grey with wells logo	3
28	AJ02034	Inflow 400x160x75 (BCM)	3
29	AJ00060	Wells two colour	4
30	AJ00242	Jet water circulation tank - 300x150x150	3
31	AJ00245	Jet water circulation tank leveling n.c.	3
32	AJ00246	Sealing for jet water circulation	3
33	AKU00684	Water Drain - 20.8" V2	1

Product family: USA Line	
Sheet name: MONT BLANC (Elbrus 230)	Product family: USA Line
File name: F:_PRODOTTI_EMO_MONT-BLANC_Elbrus 230L_westline_USA	Product family: USA Line
Dimension spa: 2300x2000x900 mm	E: 91" x 78" V: 68" - 68"
Weight of the SPA: 370 kg	True floatation: 2000x2000x900 mm
Riser height: 137 mm	Approved by: Underwater Standard
Created: 2020-03-24	Drawn: Underwater Standard - 2020-03-24 16:05:54
Low rate electricity: 2130	Warranty: 5 years
1 person - 75 kg	Warranty: 5 years
Water depth: 683 kg	Warranty: 5 years
Maximum water: 1190 liter	Warranty: 5 years

MAJOR COMPONENTS OF THE PRODUCT

MONTE BIANCO (DISCOVERY)

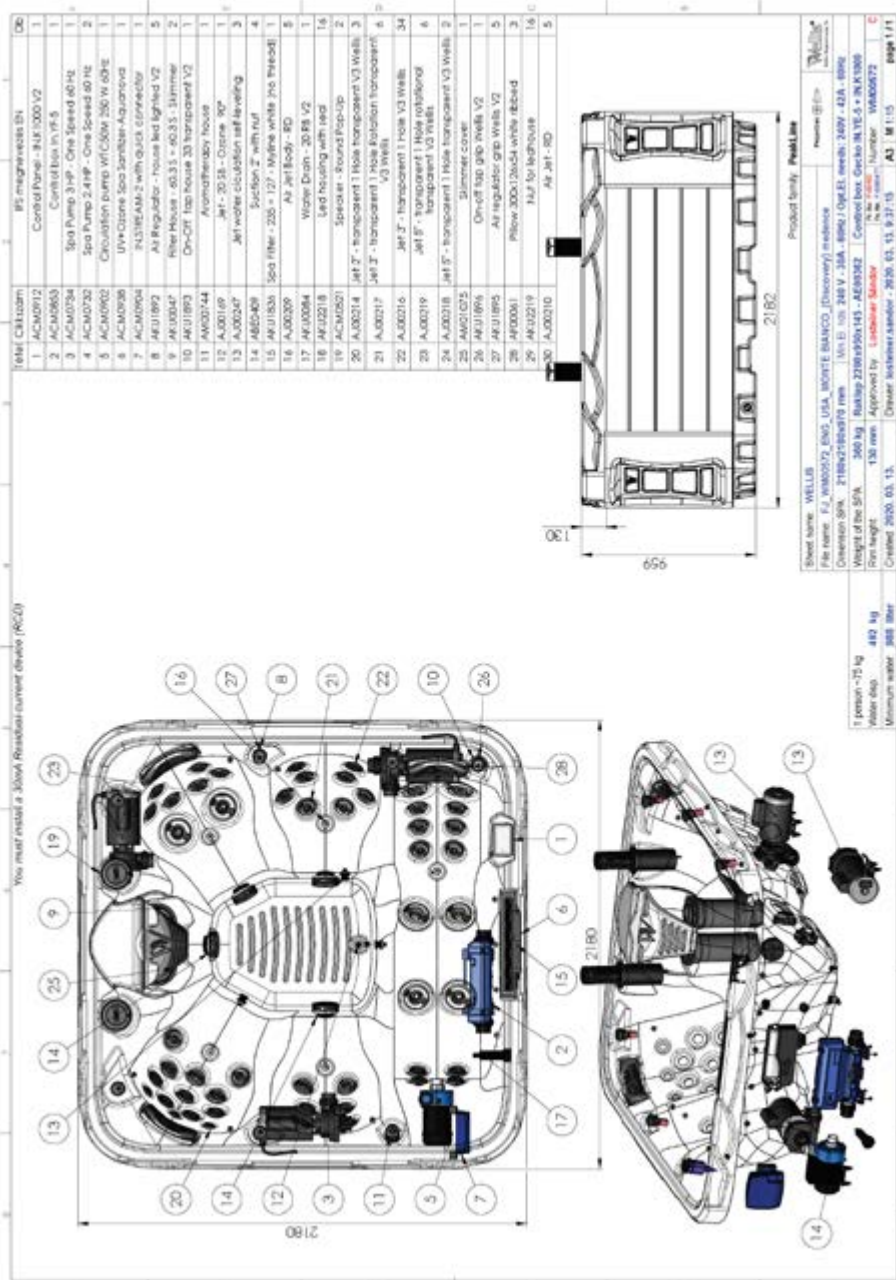

MAJOR COMPONENTS OF THE PRODUCT

MONTE ROSA (KILIMANJARO)

Item	Code	Description	Qty
1	ACM0204	Spig Pump 3 hp - One Speed 60 lit	3
2	ACM0202	Circulation pump WTC500 200 W 60Hz	1
3	ACM0653	Control Box 1A V.E.S.	1
4	ACM0712	Control Panel - INT 1000 V2	1
5	ACM0708	Unicore Ion Sanitizer Aguardia	1
6	ACM0049	Speaker - Dual 8Ω	2
7	AM02018	Led housing with seal	13
8	ACM0504	BUSTREAM 2 with quick connector	1
9	ACM0049	Subwoofer 285W	1
10	ACM0608	Underwater Light - RGB 17 Inch	1
11	ACM0031	Underwater Light - House HD	1
12	AMU1893	On-Off tap house 33 transparent V2	1
13	AMU0044	Water Pop-Up Fountain	2
14	AMU1892	A3 Regulator - house led light V2	5
15	AM00744	Aromatherapy house	1
16	AMU1891	Water Overter 60 - LED light V2	1
17	AMU0055	On-Off tap house light blue transparent	3
18	A-00014	Jet water circulation refering	3
19	AM04079	Socket 2" with mt	4
20	A-00019	JET - 20.38 - Orange 10"	1
21	AMU0064	Water Drum - 20 lit V2	1
22	A-00014	JET 2" - transparent 1 Hole transparent V3 Wells	27
23	A-000216	JET 3" - transparent 1 Hole V3 Wells	6
24	A-00017	JET 2" - transparent 1 Hole Rotation transparent V3 Wells	20
25	A-00018	JET 5" - transparent 1 Hole transparent V3 Wells	7
26	A-00019	JET 5" - transparent 1 Hole Rotation transparent V3 Wells	4
27	AMU1894	Water Overter - Sep Wells V2	1
28	AMU1895	A3 regulator gnd Wells V2	5
29	AMU1896	On-off tap gnd Wells V2	1
30	AMU1833	Pipe House - transparent over grey with Wells top	1
31	AMU1835	Stainless House Spirt grey	1
32	AF00040	Panel 400x160x25 (POM) Wells two colour	3
33	AMU0136	Top Filter 170 x 130 Wells adjustable filter 3 Heads	3

You must install a 30mA Residual-current device (RCD)

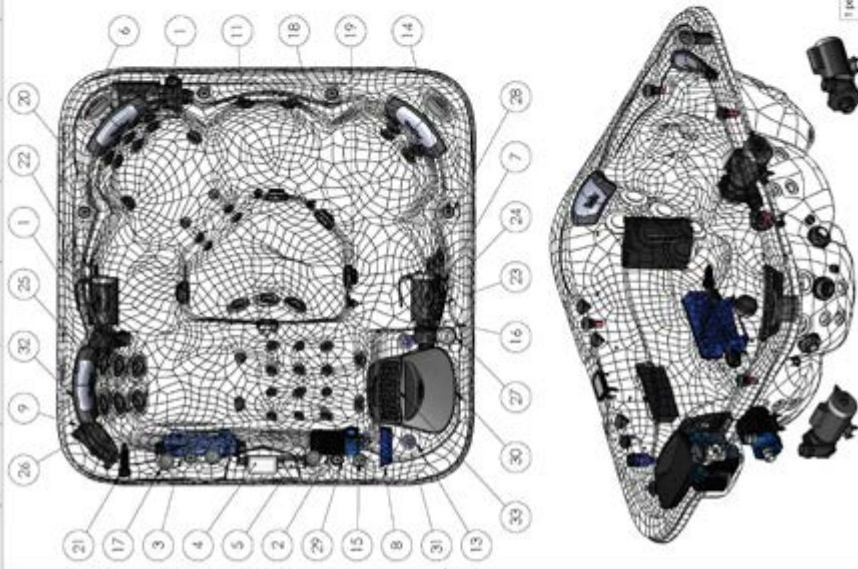

Product family: USA Line

Sheet name: WELLS	Product family: USA Line
File name: P2_0000517_MONTE_ROSA_Kilimanjaro_embalaje_USA	Numero BOM:
Dimension spm: 220x220x140 mm	Min E: 105 - 240 V - 50A - 60Hz / Ojet/E: 240V - 240V - 40A - 60Hz
Weight of the SPA: 347 kg - max 220mmx200mm spa - 40mm	Control box: GECKO T.E.S + 10000
Min height: 100 mm	Approved by: Unibever S.p.A.
Created: 2020 - 03 - 15	Drawing list/serie number - 2020 - 03 - 15 - 11-23-04mm - A3 M 1/7

1 person -75 kg
 484 kg
 Minimum water: 1500 liter

MAJOR COMPONENTS OF THE PRODUCT

PARIS (ELBRUS 2018)

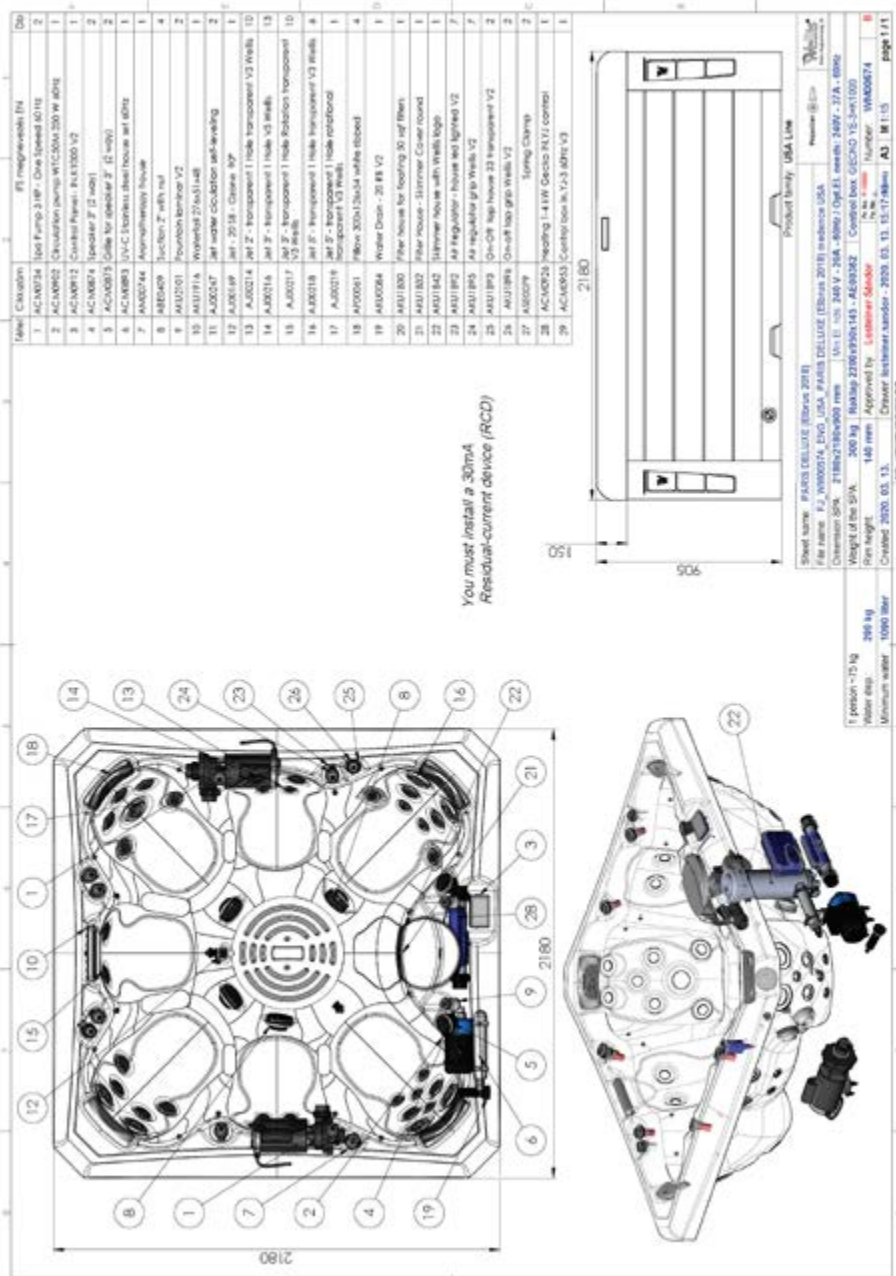

MAJOR COMPONENTS OF THE PRODUCT

LONDON (MALAGA 2018)

Part	Callstone	Part description	Qty
1	ACM07M	3/8" PVC 3/4" - Ops Speed 60Hz	2
2	ACM0902	Circulation pump WTC50N 250 W 60Hz	1
3	ACM0854	Control box IN V-3	1
4	ACM0912	Control Panel - 30x1000 V2	1
5	ACM0846	Superpoder 280W	1
6	ACM0893	UV-C 300Watts steel house set 60Hz	1
7	ACM0814	Speaker 3" (2 way)	2
8	ACM0875	Gels for speaker 3" (2 way)	2
9	ACU1916	Wigtail 27x3 v4b	1
10	AMU1051	Fountain lamping V2	3
11	AMK0744	Aromatherapy house	1
12	ABM069	Suction 2" with nut	2
13	AMK0247	Jet water circulation with wiring	2
14	AMK0149	Jet - 20.58 - Ozona 90"	1
15	AMU0084	Waller Drain - 20x95 V2	1
16	AMU1300	Filter house for floating 30 x 60 fibres	1
17	AMU1302	Riser House - Stainless Cover round	1
18	AMU1842	Strimmer House with Walls top	1
19	AMU1581	Water Diverter 60" - LED lighted V2	1
20	AMU1892	Air Regulator - house led lighted V2	2
21	AMU1893	On-Off 180 house 33 transparent V2	4
22	AMU1894	Water Diverter - On-Off V2	2
23	AMU1895	Air regulator 90° V2	4
24	AMU1896	On-Off 180 90° V2	2
25	AMK0314	Jet 2" - transparent 1 hole transparent V3 wells	5
26	AMK0216	Jet 2" - transparent 1 hole V3 wells	14
27	AMK0217	Jet 2" - transparent V3 hole position	8
28	AMK0218	Jet 5" - transparent 1 hole transparent V3 wells	9
29	AMK0219	Jet 5" - transparent V3 wells (optional)	4
30	AMK0041	Roller 300x120x51 white REBed	3

You must install a 30mA Residual-current device (RCD)

Product family: USA Line

Stock code: LONDON Deluxe (Malaga 2018)

File name: E:\W000377_Eng_LON... LONDON Deluxe (Malaga 2018) reference

Customer USA: 11892330000 | Qty: 1 | 24 V - 25A | 40W / 0.63 amps | 3492 / 37A | 480W

Weight of the SPA: 350 kg | net wt. incl. accessories - 440kg | Control box: Gencio 98.16.3 - 98.16.098

Print height: 148 mm | Approved by: **Lubliner Slovakia** | No. in stock: **W000377**

Created: 2020. 05. 13. | Order reference number: 2920. 05. 13. 13:24:08ms | A3 | 1/20 | page 1/11

MAJOR COMPONENTS OF THE PRODUCT

MILAN (PALERMO 2018)

Part Name	Quantity	Part Number	Description
1	1	ACM007M	Stop Pump 3HP - One Speed 60Hz
2	1	ACM002	Circulation pump WTCOM 250 W 60Hz
3	1	ACM0093	UV-C Filter 99.99% filter houses 181.60Hz
4	1	ACM0004	84.59FAM-2 with quick connector
5	1	ACM0012	Control panel - 1181.1000 V2
6	1	ACM0049	Subwoofer 20W
7	2	ACM0074	Sprinkler 3" (2 way)
8	2	ACM0075	Gills for speaker 3" (2 way)
9	1	AMU1000	Filter house for floating 30 rcf filter
10	1	AMU1002	Filter house - Summer Cover round
11	1	AMU1042	Summer house with Wells logo
12	1	AMU1043	Water Diverter ab - LED lighted V2
13	5	AMU1092	Air Regulator - house led lighted V2
14	2	AMU1093	On-Off Top house 33 transparent V2
15	1	AMU1094	PopUp Diverter - Grip Wells V2
16	5	AMU1095	Air regulator 600 Wells V2
17	2	AMU1096	On-Off Top 600 Wells V2
18	1	AMU1097A	Waterjet 27x45x148
19	1	AMU0074A	Aeromembrane house
20	4	AMU0250	Four-hole barbed V2
21	4	AMU0250	Six-Hole 3" with rail
22	1	AMU025	MH - 20.03 - Coarse 10P
23	2	AMU04P	Jet water circulation self-levelling
24	1	AMU0054	Water Drain - 20.05 V2
25	3	AMU0061	Flow 200x120x44 white ribbed
26	1	AMU1030	Spiller 37" (5) white 30" w/ no head
27	50	AMU0216	MH 3" - transparent 1 Hole V3 Wells
28	10	AMU0217	MH 3" - transparent 1 Hole 6x10.50x50
29	6	AMU0218	MH 5" - transparent 1 Hole transparent V3 Wells
30	6	AMU0219	MH 5" - transparent 1 Hole total/total transparent V3 wells
31	1	ACM0026	Heating 1-4kW Circle RLT2 control
32	1	ACM0053	Control box IN.1.3.60Hz V3

You must install a 30mA Residual-current device (RCD)

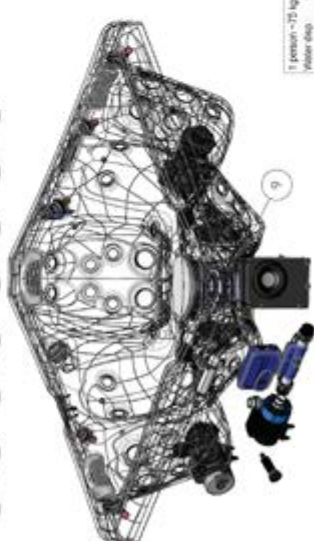
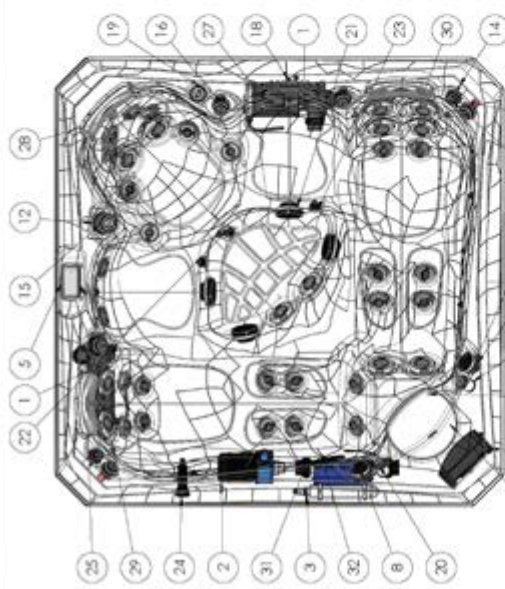
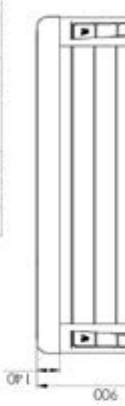

Sheet name: MILAN_DELUXE_(Palermo)	Product family: USA Line
File name: F2_0000537_EMO_USA_DELUXE_DELUXE_(Palermo_2018)_enduse	Version: 0/0
Dimension (mm): 353 mm (13.89") x 240 V x 354 (9.63") x 160 mm (6.30") x 160 mm (6.30")	Control box: Circle ML 2.3 x ML 3.000
Weight of the SPA: 353 kg	Approved by: Lochner Stalder
Item height: 140 mm	Number: W0000877
Created: 2020_03_16	Drawn: Andreas Stalder - 2020_03_16_13:21:16
	AS M 1.5
	page 1 / 1

MAJOR COMPONENTS OF THE PRODUCT

BERLIN (MARBELLA 2018)

Part	Chisom	Part description	QTY
1	ACM0912	Control Panel - R411000 V2	1
2	ACM053	Control box in V3, A046 V3	1
3	ACM0734	Soa Pump - JHF - Omi 50045 0712	1
4	ACM0902	Circulation pump WCC50M 200 W A046	1
5	ACM0924	Heating - 4 UV Grills R1 V1 (control)	1
6	ACM0993	UV-C Stainless steel house jet 50W	1
7	ACM0904	RL1924W-2 with quick connector	1
8	ACM0873	Gate for sprayer 3" (2 way)	2
9	ACM0874	Special 3" (2 way)	2
10	ACM0549	Subwoofer 285W	1
11	AD00041	Flow 2001 26x44 white fibred	4
12	AJ00218	Jet F - transparent 1 hole transparent V2	2
13	AJ01914	Waterjet 27x40x148	1
14	AJ01986	On-off top grip with V2	2
15	AJ01993	On-off 150 house 33 transparent V2	2
16	AJ0214	Jet F - transparent 2 hole transparent V3	8
17	AJ03009	Suction 3" with nut	3
18	AJ01991	Water Diverter -6- LED lighted V2	1
19	AJ01994	Water Diverter - Grip with V2	1
20	AJ02047	Jet water circulation self-cleaning	3
21	AJ02016	Jet 3" - transparent 1 hole V3 necks	10
22	AJ02101	Rotation lance V2	3
23	AJ02149	Jet - 20.58 - Ozonre 50"	1
24	AJ0217	Jet 3" - transparent 1 hole rotation	10
25	AJ01992	A3 Regulator - house led lighted V2	4
26	AJ01942	Summer house with mesh logo	1
27	AJ01932	Filter house - 3" immer Cover round	1
28	AM00544	Automatic hour	1
29	AJ01995	A4 regulator grip with V2	4
30	AJ01930	Filter house for Roofing 50 of filters	1

You must install a 30mA Residual-current device (RCD)

Part	Weight	Volume
1 person - 75 kg	168 kg	168 l
Minimum water	703 liter	703 l

Product family: USA Line
 Model name: BERLIN DELUXE (Marbella 2018)
 File name: E2_1402023_010_USA_BERLIN DELUXE (Marbella 2018).indd
 Created: 05/11/2018 10:58:56 AM
 User: J. L. C. 24 V, 114, 4099 / 04/11/2018, 10:58:56 AM, 2018, 2018, 4880
 Country: USA - 1959x1300x650 mm (L x B x H) 24 V, 114, 4099 / 04/11/2018, 10:58:56 AM, 2018, 2018, 4880
 Weight of the SPA: 229 kg (with mesh installation) (with frame) Control box: C02020 V2-2141002
 Print height: 148 mm Approved by: **Lubliner Slovakia** File name: W4000576
 Created: 2020.03.18. 09:05:15. 13:12:28 A3 | 1/15 page 1/11

MAJOR COMPONENTS OF THE PRODUCT

TAURUS (KILIMANJARO)

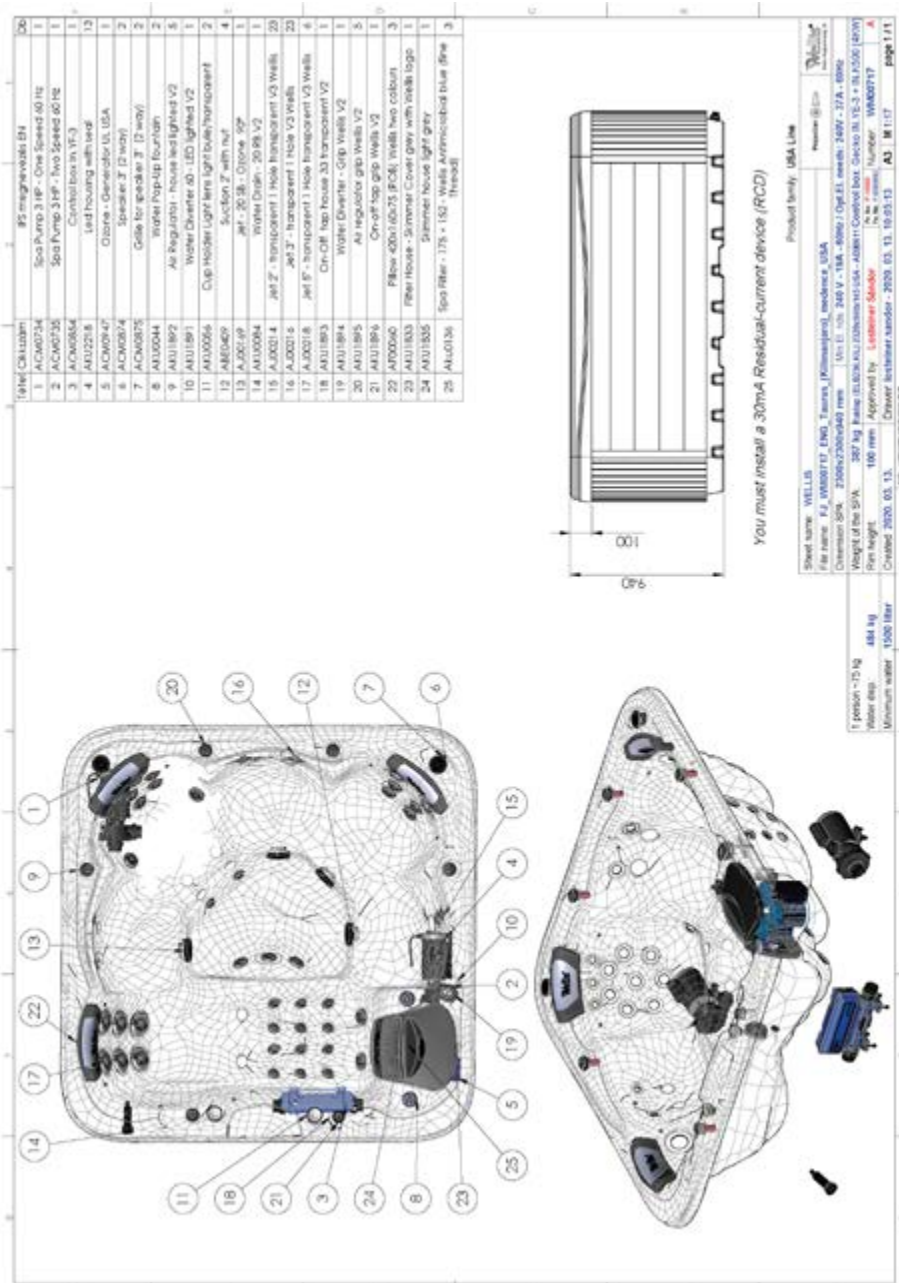

MAJOR COMPONENTS OF THE PRODUCT

LIBRA (ELBRUS 230)

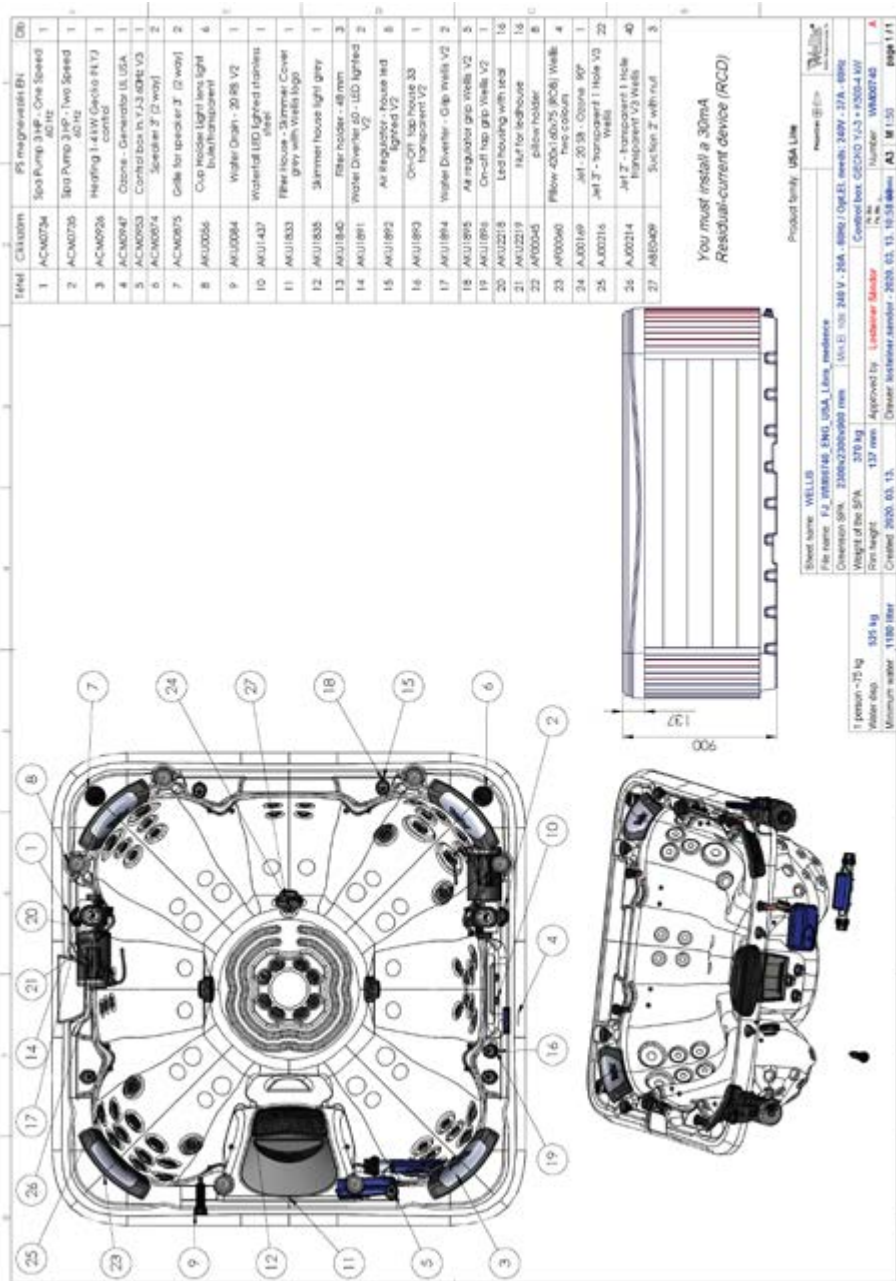

MAJOR COMPONENTS OF THE PRODUCT

HERCULES

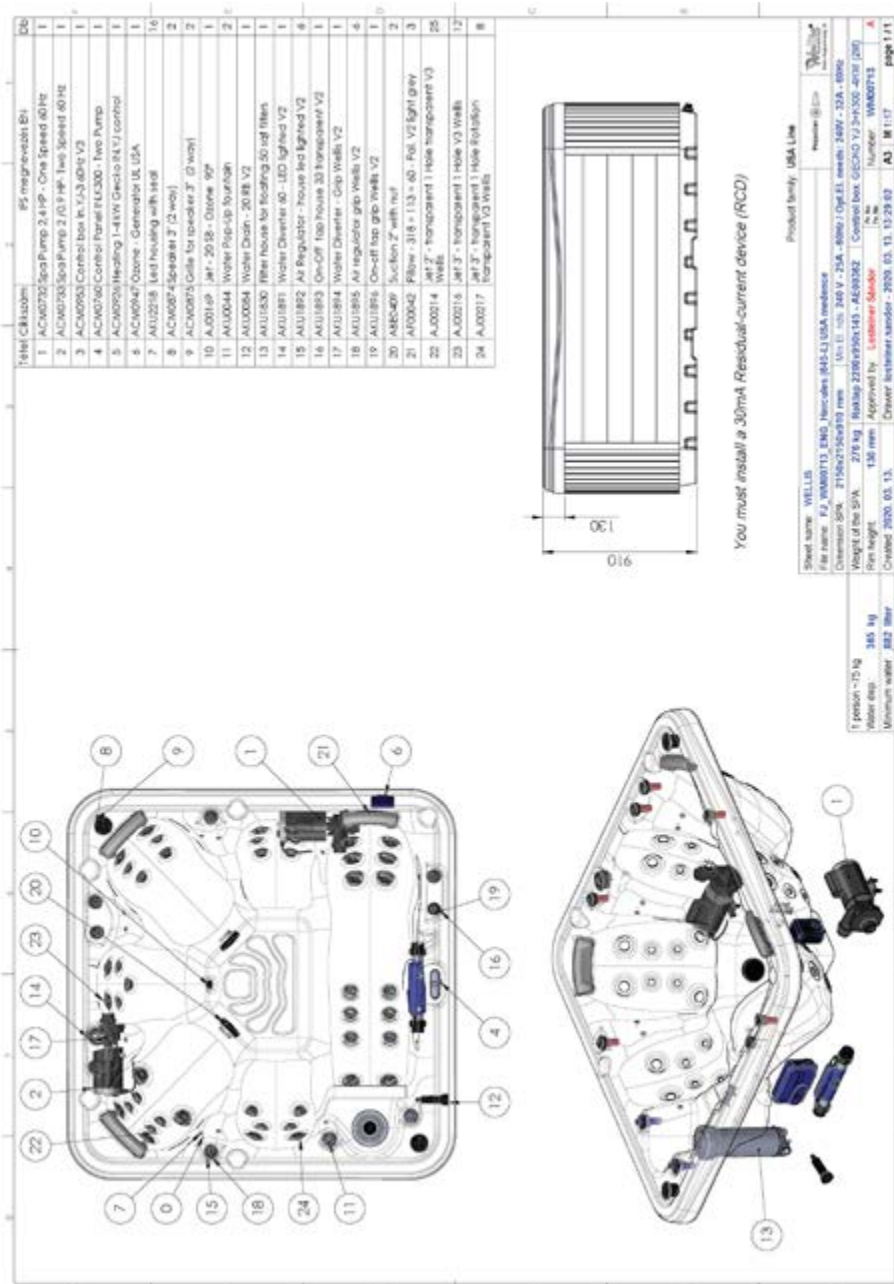

MAJOR COMPONENTS OF THE PRODUCT

LEO P&P

Tel#	Cikkszám	IF3 megrevezés EN	Db
1	ACH0945	Spa Pump 1,5HP - Two Speed 60 Hz	1
2	ACH0924	Heating 1.4 KW Geyser IN.Y control	1
3	ACH0926	Control Box IN.Y,2,3,6,8,10,12,14,16,18,20,22,24,26,28,30,32,34,36,38,40,42,44,46,48,50	1
4	ACH0739	Control Panel IN.Y,3,6,8,10,12,14,16,18,20,22,24,26,28,30,32,34,36,38,40,42,44,46,48,50	1
5	AKU0218	LED housing with seal	14
6	ACH0947	Ozone - Generator UL USA	2
7	ACH0874	Speaker 3" (2 way)	2
8	ACH0875	Gills for speaker 3" (2 way)	2
9	AKUI891	Water Diverter 60 - LED lighted V2	1
10	AKUI894	Water Diverter - Grip Wells V2	1
11	AKUI892	Air Regulator - Grip Wells V2	5
12	AKUI895	Air regulator - house led lighted V2	5
13	AKU0047	Filter House - 60.3 S x 60.3 S - Skimmer	1
14	AKU0084	Water Drain - 20 RB V2	1
15	AJ00214	Jet 2" - transparent 1 Hole transparent V3 Wells	30
16	AJ00216	Jet 3" - transparent 1 Hole V3 Wells	2
17	AJ00217	Jet 3" - transparent 1 Hole Rotation transparent V3 Wells	4
18	AJ00242	Flow - 3.18 x 1.13 - 60i- V2 light grey	3
19	AJ00285	RD Suction Nut	1
20	AKU0267	RD Suction 2" with gasket	1
21	AJ00286	RD Suction Compensation Ring	1
22	AJ00291	Jet ozone with sealing V2	1
23	AJ00292	Ozone nut self-aligning V2	1
24	AJ00246	Washer self-aligning	1

Suggested electrical connection side

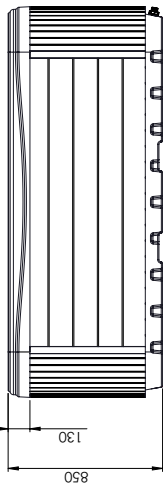
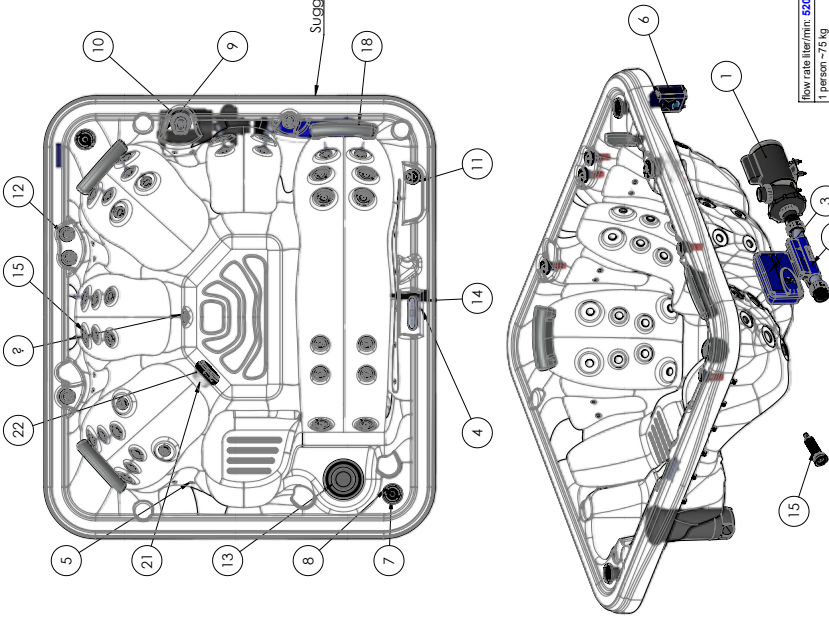

Sheet name: LEO P&P	Product family: USA Line
File name: FJ_WHM00711_ENG_LEO P&P (S&L) -residence USA	Preparation:
Dimension SPA: 2150x1900x850 mm E: 103: 120 V - 12A - 60Hz	
Weight of the SPA: 220 kg Packaging: 2100x880x145 - AE00091 Control box: GECKO V2x4300 - 14W (14M)	Number: WHM00711
Rim height: 130 mm Approved by: Lesbaster Sándor	Number: WHM00711
Created: 2022.05.18 Drawer: lesbaster.sander - 2022.05.18, 16:24:32 AS3 M:1:5	page 1/2

MAJOR COMPONENTS OF THE PRODUCT

LEO SCANDI PACK

LEVO	Call number	IFS designation	Qty
1	AC00235	Spd Pump 3 HP - Two Speed 60 Hz	1
2	AC00299	Control Panel RL006 - One Pump	1
3	AC00952	Control Box IN.Y.2 OctoLo 60Hz V2	1
4	AC00926	Heating 1-4 kW GledLo IN.Y.7 control	1
5	AC00947	Clzone - Generator UL USA	1
6	AC00874	Speaker 2" (2 way)	2
7	AJ00047	Filter H50w - 60.3.5 x 60.3.5 - Summer	1
8	AJ00084	Water Drain - 20 IS V2	1
9	AJ01891	Water Diverter 60 - LED lighted V2	1
10	AJ01892	Air Regulator - hose led lighted V2	5
11	AJ01897	Water Diverter - Dip heated V2	1
12	AJ01895	Air Regulator - Dip heated V2	1
13	AJ02215	LED housing with seal	14
14	AS00814	Self adjustment for suction	1
15	AS00620	Silicon gasket for suction 2"	1
16	AS00620	Suction 2" with seal	1
17	AJ01619	Jet 2 - 30.33 - Choke, ROP	1
18	AJ00214	Jet 2 - transparent 1 Hole transparent V3 Wells	16
19	AJ00216	Jet 3 - transparent 1 Hole V3 Wells	10
20	AJ00217	Jet 3 - transparent 1 Hole Rotation transparent V3 Wells	10
21	AN00027	Blow Pattern	3

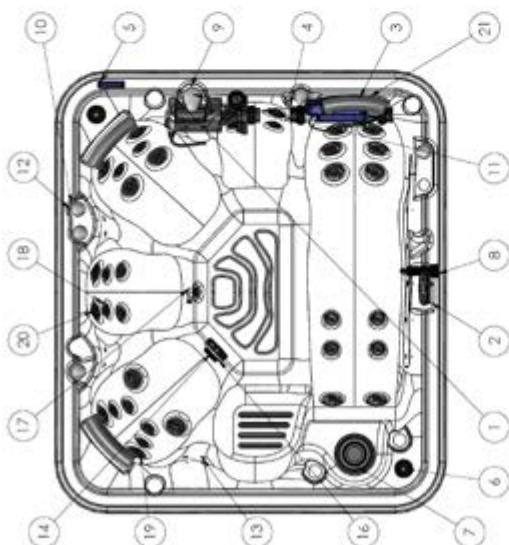

You must install a 30mA Residual-current device (RCD)

Product family: USA Line

Sheet name: WELLS	Product family: USA Line
File name: F2_wells0115_EMG_lev_1534-1_medline_wel	Product ID: WELLS0115
Dimension (mm): 2150x1000x1050 mm	Dimensions: 84.6" x 39.4" x 41.3"
Weight of the SPA: 250 kg	Weight: 551.1 lb
Jet height: 120 mm	Jet height: 4.72"
Created: 2020-03-16	Created: 2020-03-16 10:48:04 AM
Approved by: Lothar Stauder	Approved by: Waldemar
Drawn: Andreas Stauder	Drawn: Waldemar
Number: WELLS0115	Number: WELLS0115
Page: 1 / 1	Page: 1 / 1

1 person -75 kg
Water depth: 120 mm
Minimum water: 712 liter

MAJOR COMPONENTS OF THE PRODUCT

ORION P&P

Tétel	Cikkszám	Ífj. megnevezés	Dt.
1	ACU0945	Spa Pump 1,5 HP - Two Speed 60 Hz	1
2	ACU0926	Heating - 1.4 kW Gecko IN.VI control	1
3	ACU0952	Control Box NLY L2 Gecko 40Hz V3	1
4	ACU0359	Control Panel IN L300 - One Pump	1
5	ACU0374	Speaker 3" (2 way)	2
6	ACU0075	Grille for speaker 3" (2 way)	2
7	AKU1892	Air Regulator - house led lighted V2	3
8	AKU2219	Nut for bedhouse	10
9	AU00169	Jel - 20 SB - Ozone 6g	1
10	AKU0047	Filter House - 60.3 S * 60.3 S - 3Stemmer	1
11	AKU1898	Air Regulator - Grip Natura V2	3
12	AU00220	Jel 12" - transparent 1 Hole transparent V3	22
13	AU00222	Jel 3" - transparent 1 Hole transparent V3 neutral	4
14	AU00223	Jel 3" - transparent 1 Hole rotational transparent V3 neutral	4
15	AF00042	Flow - 3.18 * 11.3 * 60 - Pol. V2 light grey	2
16	AU00286	RD Suction Compensation Ring	1
17	AKU12607	RD Suction 2" with gasket	1
18	AU00285	RD Suction Nut	1

Suggested electrical connection side

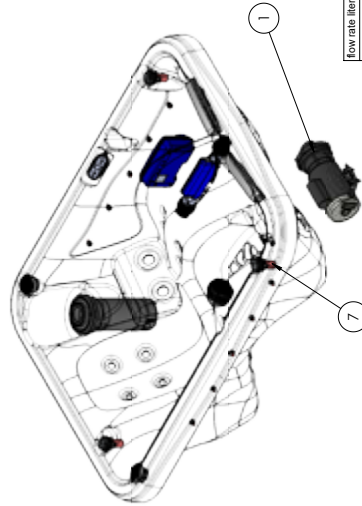
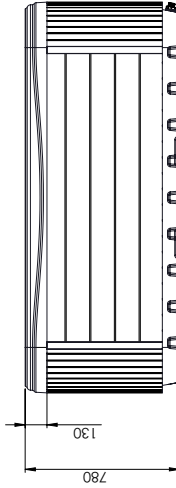
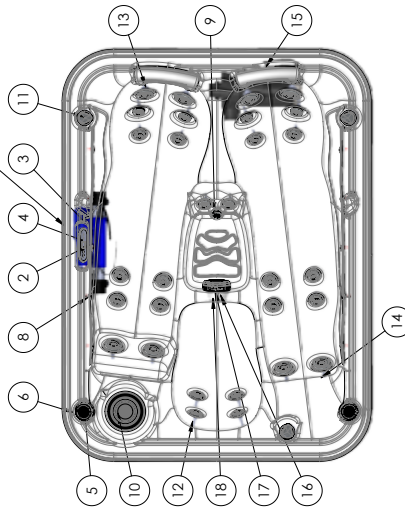

Product family: USA Line	
Sheet name: WELLS	Project no:
File name: F:\W000710_ENG_Orion P&P (33-3L) msdinos USA	
Dimension SPA: 2000x1500x750 mm	El. nos: 120 V - 12A - 60Hz
Weight of the SPA: 170 kg	Raklap 1540x880x145 - A-E00960
Rim height: 130 mm	Approved by: Customer Sander
Created: 2022.05.09.	Drawer: testeneer.sander - 2022.05.09. 11:59:59
Low rate filter/min: 520	Control box: GECKO V2x4300 - 1KW (HM)
1 person - 75 kg	For spa status: Number: W000710
Water disp.: 247 kg	
Minimum water: 487 liter	
	page 1 / 2

MAJOR COMPONENTS OF THE PRODUCT

ORION SCANDI PACK

Part No.	Callout	Part Description	Qty
1	AC00736	IP5 magnetizable BT	1
2	AC00740	Spd Pump 3hp - Two speed 60 Hz	1
3	AC00742	Control Panel IN1200 - Two Pump	1
4	AC00743	Control Box IN1200 - 60Hz V3	1
5	AM11582	AI Regulator - mouse led lighted V2	3
6	AM00584	Self adjustment ring for suction	1
7	AM00585	Suction 2" with nut	1
8	AM00586	Suction gasket for suction 2"	1
9	AM00587	Filter House - 60.3 x 60.35 - Skinner Jet - 20.58 - Orange 10P	1
10	AM00588	Water Drain - 20.18 V2	1
11	AC00747	Clzone - Generator US, USA	1
12	AC00748	Speaker 2" (3 way)	2
13	AC00875	Gills for speaker 3" (2 way)	2
14	AM11585	Air Regulator - Grip Material V2	3
15	AM00200	Jet 2" - transparent 1 Hole transparent V3 manual	18
16	AM00222	Jet 3" - transparent 1 Hole transparent V3 manual	8
17	AM00223	Jet 3" - transparent 1 Hole optional transparent V3 manual	4
18	AM00042	Filler - 218 x 113 x 60 - Pol. V2 light grey	2
19	AM12099	LED Light - Lens V2	10

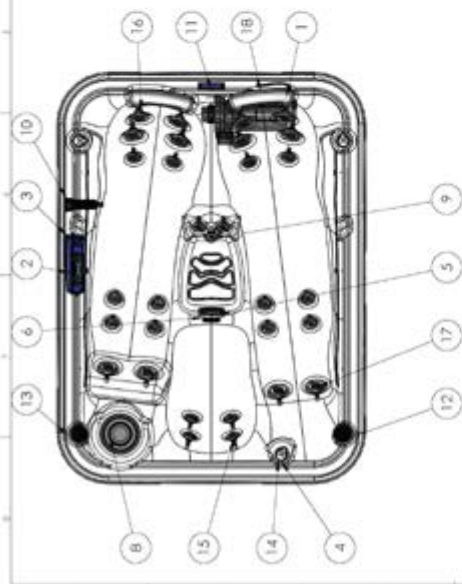

You must install a 30mA Residual-current device (RCD)

Sheet name:	WELLS	Product family:	USA Line
File name:	F:_0000718_Eng_Orion_1200-2L_madness_USA	Part name:	IP5 magnetizable BT
Dimension size:	2000x1000x750 mm	Unit:	mm
Weight of the SP:	170 kg	Created:	05.11.2018 10:24 V.104
Part height:	120 mm	Approved by:	Lockwood-Moore
Created:	2020.05.15	Drawn:	lockwood-moore
		Number:	W0002718
		Scale:	A3 M 2:0
		Page:	page 1 / 1

USER INTERFACE - K300

EASY 4

COMPACT FULL-FUNCTION KEYPAD

The Quick Reference Card provides an overview of your hot tub's main functions and the operations accessible from your digital keypad. This QRC depicts a generic overlay, custom versions may vary.

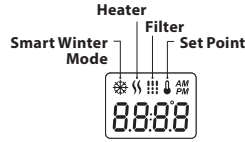

1 PUMP MODEL

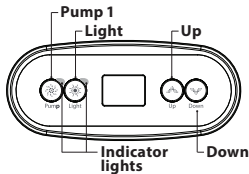

2 PUMP MODEL

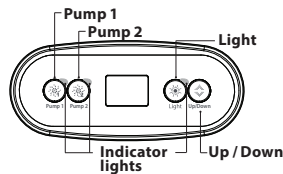

HOT TUB FUNCTIONS



OFF MODE

Pressing Pump 1 for 5 seconds will enable the Off mode. This mode allows you to stop all outputs including automatic functions such as filter cycle, heat request and smart winter mode for 30 minutes to perform quick hot tub maintenance. When Off mode is active, the display will toggle between the "OFF" message, the clock and the water temperature.

The hot tub light will flash for a few seconds before the end of the 30 minutes to warn you that the system is about to resume its normal operation. Press Pump 1 or Pump 2 (if available) to restart the system before the expiration of the 30 minute delay. When the system resumes its normal operation, the display shows "On" for 3 seconds.

PUMP 1

Press Pump 1 key to turn Pump 1 on at low speed. Press a second time to turn pump to high speed (with a dual-speed pump*). A third time turns pump off. A built-in timer automatically turns pump off after 20 minutes, unless pump has been manually deactivated first.

The "Pump 1" indicator lights up when Pump 1 is on. With a dual-speed pump, the indicator will flash when pump 1 is on at low speed.



PUMP 2 KEY

Not available on all models. Press Pump 2 key to turn Pump 2 on at low speed. Press a second time to turn pump to high speed (with a dual-speed pump*). A third time turns pump off. A built-in timer automatically turns pump off after 20 minutes, unless pump has been manually deactivated first.

The "Pump 2" indicator lights up when Pump 2 is on. With a dual-speed pump, the indicator will flash when pump 2 is on at low speed.



LIGHT KEY

Press Light key to turn light on. A second press turns light off. A built-in timer automatically turns light off after 2 hours, unless it has been manually deactivated first.

The "Light" indicator lights up when light is on.



UP/DOWN KEYS

Use Up or Down key to set desired water temperature. The temperature setting will be displayed for 2 seconds to confirm your new selection.

2 pump hot tubs have a combined Up/Down key. Hold the button to increase the parameter and release the button to stop. Hold the button again to decrease the parameter.

The "Set Point" icon indicates that the display shows the desired temperature, NOT the current water temperature!

*If single speed pump: press Pump key to turn pump on. Press Pump key again to turn pump off.

PROGRAMMING STEPS



PROGRAM MENU



The program menu is accessible by holding down the Light key for 5 seconds. In the program menu the following parameters can be set: clock, the filter or purge cycles, economy mode and temperature units. While you are in the program menu, use the Up or Down key to adjust the parameters and use the Light key to jump to the next parameter.

The changes will be saved after the confirmation of the last parameter only. If there is no action taken for 10 seconds, the system will exit the program menu without saving any changes.

SETTING THE CLOCK

Enter the program menu by holding down the Light key for 5 seconds. The display will show the current clock setting with the hour flashing.

Depending on factory settings your system may be set to 24-hour time or 12-hour time.

Setting the hour: Use the Up or Down keys to adjust the hours. Press the Light key to jump to the next parameter, the minutes.

Setting the minutes: Use the Up or Down keys to adjust the minutes. Press the Light key to jump to the next parameter, the filter or purge start time (FS).

PROGRAMMING THE FILTER/PURGE CYCLES

Depending on system configuration your hot tub will perform either a filter or a purge cycle. The filter cycle menu consists of the following parameters: the start time (FS), the duration (Fd) and the frequency (FF). The purge cycle menu consists of the following parameters: the start time (FS) and the frequency (FF).

A filter cycle consists of starting all the pumps and blower in high speed for 1 minute (purge step) then, the pump associated with the filter will run in low speed for the remaining duration of the filter cycle (clean step).

A purge cycle is used when the hot tub is equipped with a 24 hour circulation pump which provides a continuous clean step. It consists of starting all the pumps and blower in high speed for 1 minute.

SETTING FILTER OR PURGE CYCLE START TIME

The display will show FSxx, "xx" representing the starting hour of the cycle. Use the Up or Down key to adjust the hours. Use the Light key to jump to the next parameter, filter duration (Fd).



SETTING FILTER CYCLE DURATION

(not available on purge systems)

The display will show Fdxx, "xx" representing the duration in hours of the filter cycle. Use the Up or Down key to adjust the duration. Use the Light key to jump to the next parameter, filter or purge frequency (FF).

0 = no filtration

24 = continuous filtration

It is not recommended to set this to "0".

SETTING FILTER OR PURGE CYCLE FREQUENCY

The display will show FFxx, "xx" representing the number of cycles per day. Use the Up or Down key to adjust the frequency. Use the Light key to jump to the next parameter, economy mode (EP).

The "Filter cycle" indicator lights up when filter is on and flashes when suspended.

SETTING ECONOMY MODE

This mode allows you to lower the temperature set point of the spa by 20 °F (11 °C) during a certain period of the day.

The display will show EPx, "x" representing the state of the programmed economy (0 = disabled, 1 = enabled). Use the arrow keys to enable or disable economy mode. Use the Light key to jump to the next parameter, economy start time (ES).

SETTING ECONOMY START TIME

The display will show ESxx, "xx" representing the hour at which the economy mode will become active. Use the Up or Down key to adjust the hour. Use the Light key to jump to the next parameter, economy duration (Ed).

When the Economy mode is ON, the display will toggle between the "Eco" message, the time, and the water temperature.

SETTING ECONOMY DURATION

The display will show Edxx, "xx" representing the duration in hour of the economy mode. Use the Up or Down key to adjust the hour. Use the Light key to jump to the next parameter, temperature unit.

24 = continuous economy

Note that the parameters for the economy mode settings are associated to specific low level configuration of the system that are not present in all software revisions.

USER INTERFACE - K300



SETTING TEMPERATURE UNIT

Water temperature can be displayed in either Fahrenheit (°F) or Celsius (°C). The display will show F or C.

Use the Up or Down key to change the setting. Use the Light key to save all the parameters.

SMART WINTER MODE

Our Smart Winter Mode protects your system from the cold by turning pumps on several times a day to prevent water from freezing in pipes.

The "SWM" indicator lights up when freezing is detected and flashes when the purge is active.

COOLDOWN

After heating the hot tub water to the desired Set Point, the heater is turned off, but its associated pump (Pump 1 low-speed or CP) remains on for a predetermined period of time to ensure adequate cooling of the heating element, prolonging its useful life.

WATER TEMPERATURE REGULATION

Every 15 to 90 minutes the pump will run to ensure accurate water temperature readings as well as avoid heater activation in dry conditions. After verifying pump activation and taking a water temperature reading if required, the system

automatically turns the heater on to reach and maintain water temperature at Set Point.

 Indicator flashes when taking water temperature reading.

TROUBLESHOOTING SECTION

Should an error occur, the display will show one of the following error messages toggled with the clock and the water temperature.

IN.XE ERROR CODES

DESCRIPTION



Hr

An internal hardware error has been detected in the in.xe.
Contact dealer or service supplier.



HL

The system has shut the heater down because the temperature at the heater has reached 119°F (48°C).

Do not enter the water! Remove the hot tub cover and allow the water to cool down, then shut power off and power your hot tub up again to reset the system.



AOH

Temperature inside the hot tub skirt is too high, causing the internal temperature in the in.xe to increase above normal limits. Open skirt and wait until error clears.



FLO

The system does not detect any water flow while the primary pump is running.

Check and open water valves. Check for water level.
Clean filter. If the problem persists, call your dealer or service supplier.



Prr

A problem is detected with the temperature probe.

Call your dealer or service supplier.



OH

The water temperature in the hot tub has reached 108°F (42°C).

Do not enter the water! Remove the hot tub cover and allow the water to cool down to a lower temperature.

Call your dealer or service supplier if problem persists.

USER INTERFACE - K500

EASY 7 KEYPAD LAYOUT

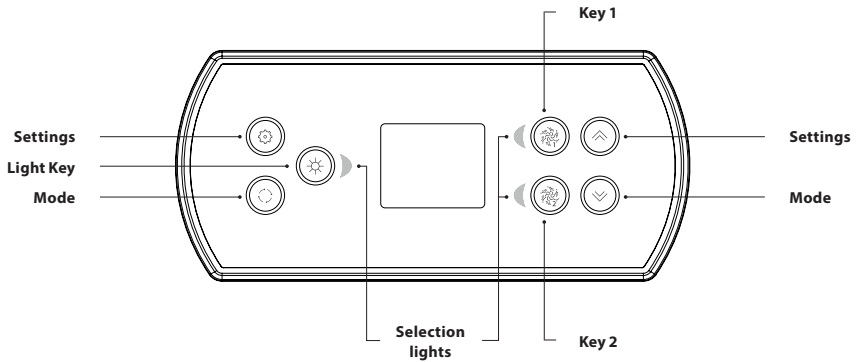

**Functions for keys 1 and 2 will depend on your system's low level configuration.*

SETTINGS KEY

One press gives you access to a menu to manage the settings of your hot tub. Refer to the settings section for details about the settings menu.

MODE KEY

Successive presses on the Mode key will give access to control different optional accessories of your hot tub such as Audio and others. Note that if an accessory is not present in your hot tub configuration, its menu will not appear. Refer to the following section to get details about the possible accessories and their detailed functionalities. The screen will revert back to the hot tub mode if no key is pressed for 60 seconds.

If you don't have any accessories on your hot tub, the Mode key can be used to directly change your display orientation.



POWER

Press any button to turn the keypad on. After 30 minutes without activity it will shut off.

MAIN SCREEN

The main screen gives you access to your accessories and water temperature. At the bottom of the screen you will see any error or maintenance messages that are present..

USER INTERFACE - K500



START OR STOP ACCESSORIES

To start or stop an accessory, press the associated button. Icons will become animated when their accessory is turned on, and inanimate when turned off. Icons on the screen will reflect the speed or state of the devices running on your hot tub. When an accessory has more than two states, press the button until it reaches the desired state.



WATER TEMPERATURE

The temperature shown at the top of the screen is the current water temperature. Use the Up and Down buttons to set the desired temperature. The set point will appear in blue at the bottom. After 3 seconds without any change to the set temperature value, the keypad will resume the normal display of messages. When the set value is lower than the current temperature Cooling to xx.x will appear. When the set value is higher than

the current temperature, Heating to xx.x will be indicated. Normally there is a short delay before the heating starts, during which Heating Suspended is indicated.



SETTINGS

From the home page you can access the Settings, where you will find:

- Water care
- Heat Pump (if installed)
- Audio (if installed)
- in.clear-200 (linked version)
- Standby
- Maintenance
- Date & time
- Keypad
- Wi-Fi
- Config
- Restore
- About

Use the arrow keys to move up and down in the list. To select an option, press the lit button beside it (Light button).

At any point you can press the Settings button to return to the home screen.

USER INTERFACE - K500

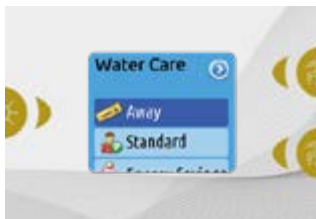

WATER CARE

The Water Care section will help you set up your ideal filtration and heating settings. Choose from Away, Standard, Energy Savings, Super Energy Savings, and Weekender, depending on your need. Use Light key to choose your setting. A checkmark will appear on the selected icon to confirm.

In Economy mode, the set point will be reduced by 20°F*, which means that the heating system will not be engaged unless the temperature falls to 20°F below the hot tub's set temperature.

* Default pack value

WATER CARE MODES



AWAY:

In this mode the hot tub will always be in economy; the set point will be reduced by 20° F*.



STANDARD:

The hot tub will never be in economy mode and will be filtering according to the pack's low level configuration.



ENERGY SAVINGS

The hot tub will be in economy mode during the peak hours of the day and resume normal mode on the weekend*.



SUPER ENERGY SAVINGS:

The hot tub will always be in economy mode during peak hours, every day of the week*.



WEEKENDER:

The hot tub will be in economy mode from Monday to Friday, and will run normally on the weekend*.

* Filtration will be reduced when the economy mode is active.

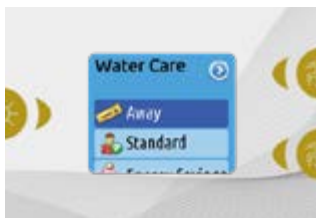

MODIFYING SCHEDULES

To see and/or modify a Water Care category, use the lit button to the right (Key 1) to open the selected Water Care menu.

Use the arrow keys to choose a schedule to modify (choice of economy and filtration schedules). Use the Light key to move between parameters.

You have several possibilities for the schedule (Mon-Fri, weekend, every day, or single days). The schedules will be repeated every week. The time and duration are set in 30 minute increments. Once you have set the schedule, use Key 1 to go back. Ensure that you have selected the desired Water Care option in the main Water Care menu.



The filtration schedule shown on the screen will apply to the main filtration pump, most likely pump 1. If your hot tub uses a circulation pump configured to run 24 hours, the screen will show you the purge setting instead of filtration. The purges are pre-programmed for a fixed number of minutes, therefore the duration will be set to N/A on the screen, and only the start time can be modified.



HEAT PUMP

This menu allow you to change the regulation mode of your heat pump. You can choose from Eco Heat, Smart Heat, Eco Auto, Smart Auto, Cool and Electric.

A green checkmark indicates the currently selected regulation mode. To change the setting, simply navigate the menu using the arrow key and press the Light Key to choose the desired regulation mode.

HEAT PUMP MODES



ECO HEAT

In this mode, the heat pump is used as the unique source of heating. The heating element is kept off and the heat pump is not used to cool the water should its temperature rise above the current set point.



SMART AUTO

This mode borrows functionality from both Smart Heat and Cool modes and has the ability to select the proper Heat or Cool mode automatically according to the water temperature. The heating element is activated only if there is a large temperature difference between the water and the set point.



SMART HEAT

This mode uses the heat pump as the main heating source. The heating element is turned on only if there is a large temperature difference between the water and the set point. The heat pump is not used to cool the water in this mode.



COOL

This mode uses the heat pump in cooling mode only. The heat pump is not used as a heating source and the heating element is never activated.



ECO AUTO

This mode borrows functionality from both Eco Heat and Cool modes and has the ability to select the proper Heat or Cool mode automatically according to the water temperature. The heating element is never activated in this mode.



ELECTRIC

This mode keeps the heat pump off and uses only the heating element to regulate water temperature.

USER INTERFACE - K500



AUDIO

The Easy 7 can be used with the in.tune, in.stream or in.stream 2 audio systems. The Audio section in the Settings menu of an in.stream gives you the option to disconnect or unpair your Bluetooth enabled device when using the in.stream.

With version 7.00 and higher, it is also possible to select Source to use a device connected by auxiliary cable or Bluetooth wireless connection.

The in.stream 2 Settings menu gives you a Source selector, a Bluetooth disconnect option, an On/Off switch and an audio control on fader, balance and subwoofer. For more information on audio functions, see the in.tune, in.stream or in.stream 2 operation section.

The Audio option will only appear in the menu for keypads that are set up for an in.stream connection. The in.stream 2 is automatically detected at power-up.



IN.CLEAR-200 / LINKED VERSION

The Easy 7 keypad can be used with the in.clear sanitization system. The in.clear section allows you to configure your maintenance settings and Boost level. For more information on maintenance and Boost settings, see the in.clear user manual.

Use the Up and Down keys to make your selection, then light key to confirm.

Use the Up and Down keys to change the maintenance or Boost value, and light key to confirm.

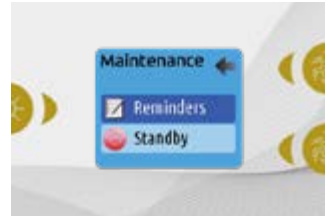

MAINTENANCE

From the Settings page you can access the Maintenance menu, which gives you access to the following options:

- Maintenance reminders
- Standby

Use the Up and Down keys to make a selection, and Light key to confirm.

** If the maintenance value is modified by more than 2, a warning message will appear with an option to cancel or confirm the change.*

USER INTERFACE - K500



MAINTENANCE REMINDERS

The Easy 7 keypad will remind you of maintenance required on your hot tub, like rinsing or cleaning the filter. Each task has its own duration, based on normal use.

The Maintenance reminders menu allows you to verify the time left before maintenance is required, as well as to reset the time once a task is completed.

Use the Up and Down keys to move through the list.

To reset a task select it by pressing Light key, then confirm when prompted. Once you have confirmed the task will be reset.

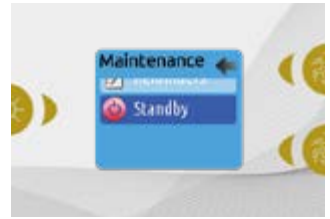

STANDBY

The Standby mode allows you to service your hot tub. Pumps will stop for 30 minutes, and automatically restart after this time.

Once Standby mode has been activated a screen will appear to show that pumps are stopped. The normal hot tub page will return at the end of maintenance.

Press the Key 1 to leave Standby mode and restart the hot tub.

Note: In version 6.00 only, Standby mode is accessible directly from the Settings page.



DATE AND TIME

Here you can adjust the time format, change the year, date and time. Use the arrows to choose the setting that you want to adjust, and select it by pressing the Light key.

Use the arrow buttons to change the parameters, and the Light key to move between parameters. Key 1 will take you back to the main Settings menu.

Note: In version 6.00 and earlier, only the day of the week can be changed, and not the year or date.



KEYPAD SETTINGS

In this section, you can change the temperature unit, language, display orientation, rim light color and keypad security. Note the hot tub pack must be configured accordingly to be able to change the rim light color.

When you change the display orientation, the contextual options and arrow keys adjust to the chosen orientation. If you don't have any accessories installed on your hot tub, the Mode key can be used as a display orientation key. Simply press on it to change your orientation from normal to inverted, and vice versa.

Whether the display is inverted or not, the Mode and Menu keys remain unchanged, as well as the accessory keys in the main Hot tub menu.



With the Easy 7 equipped with a selectable rim light color modul: If the "RGB backlight" option is enabled in the hot tub configuration an option will appear to allow selection of the keypad rim light color.

You can lock the keypad by selecting one of 3 security levels: Unlock, Partial or Full. The Partial level locks the set point adjustment and many options in the settings menu. The Full level locks all keypad functions. To unlock the keypad (either Partial or Full), press and hold the top right key for 5 seconds.

USER INTERFACE - K500

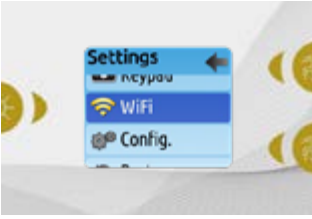

WiFi (IN.TOUCH ONLY)

For the WiFi menu to appear in the Settings menu your in.touch module must be equipped with software version 11.00 or higher. This menu allows you to connect your in.touch module to a WiFi network or to change its network.

For more details about other in.touch connection methods please see the in.touch techbook.

To connect your in.touch module to a wireless network, use the Up/Down keys to go to the WiFi option in the Settings menu and Light key to select it.

After a few seconds the available networks will appear on the screen, as well as their signal strength.

Use the Up/Down keys to move through the list. Select your network by pressing on Light key.

If the WiFi network is password protected enter it when prompted.

- Use the arrow keys to choose your letters and change the type of character (uppercase, lowercase, number, symbol).
- Use Key 2 to move the cursor forward
- Use Key 1 to backspace
- Use Light key to confirm

If no password is required the in.touch will connect automatically.



Once the in.touch module is connected to a WiFi network a check mark in a green circle will appear in the WiFi menu, and the network logo will change to green in Settings menu.

Note:

WiFi logo color in Settings menu corresponds to the in.touch connection state.

Yellow = not connected

Green = connected to a network

Yellow with wait icon = connection attempt to a network

Red with wait icon = in.touch no longer detected

(in.touch must be reset before next connection attempt)

USER INTERFACE - K500



CONFIG

Please do not make changes in the electrical configuration section unless you are a qualified electrician.

In this section you can change the low-level configuration, number of phases, input current and heat pump current.

Use Up/Down to move between parameters, and the Light key to select a parameter to change. Please refer to the techBook of your specific control system for hot tub for details about the low level settings.

Once you have changed the Number of Phases in the menu, you will be unable to use the Up/Down keys to return to the Low-level Configuration menu. Please go back and re-enter the Config menu.

Note with version 15.00 and higher:
Depending on the pack configuration, a code may be required to change these settings. This code is "5555".

The table below shows the key assignment based on the accessories selected in your pack's low level configuration. Please refer to the Quick Start Card (QSC) for specifications to identify the low level configuration for your hot tub.

POSSIBLE KEY MAPPINGS

Low level configuration	Key 1	Key 2	Light
1 pump	Pump 1	–	Light
2 pumps	Pump 1	Pump 2	Light
2 pumps + blower	Pump 1	Pump 2 + Blower	Light
4 pumps*	Pump 1 & Pump 2	Pump 3 + Pump 4	Light
3 pumps + blower*	Pump 1 & Pump 2	Pump 3 + Blower	Light

*Only pump 1 can have a dual speed.

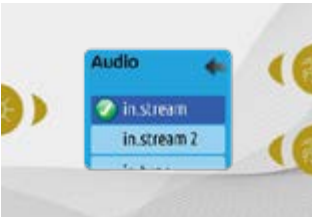

RESTORE/AUDIO CONFIGURATION

When you select Restore you will be asked to confirm your choice. Doing so will reset all settings to factory default.

Following a restore you will be asked to choose your audio source. Use the arrow key to choose between in.stream, in.stream 2, in.tune and no/other audio.

This should only be done at installation or when replacing a part.

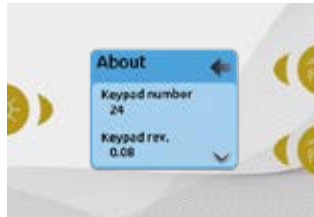

ABOUT

This section shows information about the Easy 7 software number, and the revision numbers of the different components of your system.

USER INTERFACE - K500

ERROR MESSAGES

The list below shows the different error messages that can appear on the home screen. Refer to the troubleshooting and error codes section of the TechBook for your hot tub pack system.

Code	Message
HL	Warning! HL Error
FLO - L01 FLO - L02 FLO	FLO condition - Check filter, pump, blockage, air lock and water level
NO FLO	Persistent NO FLO, all off - Check filter, pump, blockage, air lock and water level
HR	Danger! Relay stuck
OH	Warning! Hot tub temp. high
Pr	Warning! Temp. probes defective
AOH	Internal pack temp. high
FLC	Flow switch closed
SP in	Input voltage issue
RH NC	Comm. error in.xm2 - in.therm
RH ID	in.xm2 - in.therm incompatible
SC ER	Learning mode error
F1	in.xm2 Fuse # 1 is blown
F2	in.xm2 Fuse # 2 is blown
F3	in.xm2 Fuse # 3 is blown
Hr	Danger! Thermal fuse error
UPL	The hot tub pack does not have valid software. Please insert valid in.stick to reprogram hot tub pack.
CFLO	No Flow condition (in.clear)
HIBr	Add fresh water to the hot tub (in.clear)
HiBr	Add fresh water to the hot tub (in.clear)
LoBr	Add BromiCharge to hot tub water (in.clear)
NoBr	Add BromiCharge to hot tub water (in.clear)
Comm	Verify cable connections (in.clear)
Supp	Connect power cord to 240 V source (in.clear)
HP	1-99 Heat Pump error 1-99!

USER INTERFACE - K500

FEATURE MATRIX

The following table presents the features and/or options available for the Easy 7 keypad, and the earliest software version at which this feature/option is available. All versions greater than the earliest version continue to support the feature.

Keypad functions	Earliest support
Power	3.00
Main screen	3.00
Start or stop accessories	3.00
Water temperature	3.00
Settings	3.00
Water care	3.00
Water care modes	3.00
Modifying schedules	3.00
Audio	3.00
in.clear-200 (linked version)	13.00 **
Maintenance	
Maintenance reminders	7.00
Standby	6.00
Date and time	3.00
Keypad settings	
Temperature unit	3.00
Language	
English	3.00
Français	3.00
Español	6.00
Polski	6.00
Nederlands	6.00
Deutsch	6.00
Norsk	6.00
Svenska	6.00
Magyar	10.00
Italiano	10.00
Português	10.00
Česky	14.00
Display	7.00
Color	12.00
Security	15.00
Wi-Fi	7.00*
Electrical configuration	3.00
Factory reset/Audio config.	3.00
in.tune functions	3.00
in.stream functions	3.00
in.stream 2 functions	11.00
in.clear functions	13.00 **
in.mix functions	19.00
Heat pump functions	21.00
White zone 2	3.00
About	3.00

* Only available with the latest software version of the X and Y Series hot tub systems, and software version 11.00 or higher of the in.touch module.

** Only available with the latest software version of the X and Y Series hot tub systems.

SMART TOUCH

TOUCH SCREEN KEYPAD

No buttons, keys and overlays! Mode and function selection wheels, all-on or all-off one touch activation key of last used settings, interactive display icons and on-screen messages are all elements of the Smart Touch user interface designed to let hot tub users interact intuitively with their hot tub and its value-added accessories.

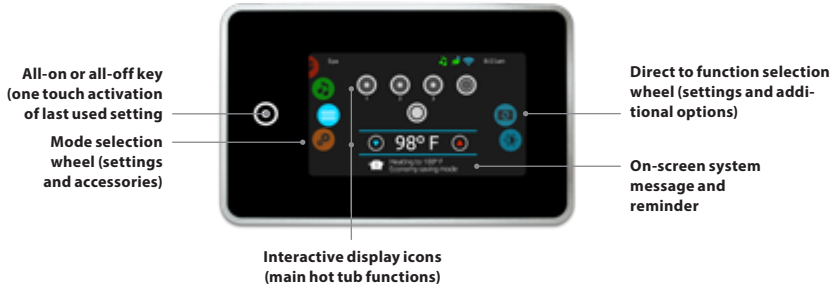

NOTIFICATION ICONS

Notification icons at the top right-hand side of the screen show the status of connected value-added accessories.



HOT TUBS FUNCTIONS

Quick and easy step-by-step instructions to control the main functions and to configure the system settings of your hot tub from its Smart Touch main hot tub keypad.



TURN KEYPAD ON

3 minutes after the last pump is turned off, the screen will shut off if there is no touch activity.

Touch the screen to turn on the keypad. Then follow the instructions on the screen to access the main screen.



ALL-ON, ALL-OFF TARGET KEY

Smart Touch features an all-on or all-off one touch activation key of last used settings that, when pressed, stops or starts all working components and accessories at once.

From the home page you can access the following modes:

- sanitization (with in.clear connected)
- audio (with Aquasoul Pro connected)
- color (with in.mix installed)
- spa
- settings

To select a mode, slide the left wheel up or down until the desired icon menu is highlighted in the middle.

SPA MODE



SPA MODE

To select the spa mode, slide the left wheel up or down until the spa icon is highlighted in the middle. The home page will be displayed its equipment start or stop keys, up and down buttons, water temperature, messages and quick access to display options:

- display orientation
- display contrast

To select an option, slide the right wheel up or down until the desired icon menu is highlighted in the middle.



START OR STOP ACCESSORIES

To start or stop an accessory (pump, blower, light), touch the associated icon. Icons will become animated when their accessory is turned on, and animation will stop when turned off.

Icons on the screen will reflect the speed or state of the devices running on your hot tub. When an accessory has more than two speeds press the button until it reaches the desired speed.



WATER TEMPERATURE

The temperature shown at the bottom of the screen shows the current water temperature. Use the Up and Down icon to set the desired temperature. The set point will appear in blue. After 3 seconds without any change to the set temperature value, the current water temperature will reappear.

When the set value is lower than the current temperature Cooling to xx.x will appear below. When the set value is higher than the current temperature, Heating to xx.x will be indicated under the value. Normally there is a short delay before the heating starts, during which Heating Suspended is indicated under the value.

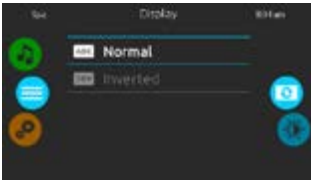

DISPLAY ORIENTATION

To modify the display orientation settings, slide the right wheel until the display orientation icon is highlighted in the middle. Simply touch the line of the orientation you want to select.

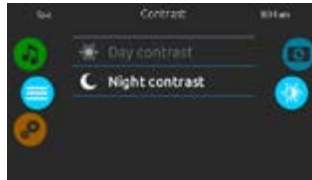

DISPLAY CONTRAST

To modify the display contrast settings, slide the right wheel until the display contrast icon is highlighted in the middle. Simply touch the line of the contrast you want to select.

SETTINGS

You can use the Settings mode to manage settings of your hot tub system.



To select the settings mode, slide the left wheel up or down until the settings icon menu is highlighted in the middle.

In the Settings page you can access the following:

- water care
- maintenance
- date & time
- keypad
- electrical configuration
- wifi
- about

To select an item, slide the right wheel until the desired icon is highlighted in the middle or press on the menu name.

WATER CARE

The Water care page will help you set up your ideal filtration and heating settings.

Choose, set or modify one of the 5 suggested modes depending on your needs at any given time.



AWAY FROM HOME

In this mode the hot tub will always be in economy; the set point will be reduced by 20° F.



BEGINNER

The hot tub will never be in economy mode and will be filtering according to the pack's low level configuration.



ENERGY SAVINGS

The hot tub will be in economy mode during the peak hours of the day and resume normal mode on the weekend.



SUPER ENERGY

The hot tub will always be in economy mode during peak hours, every day of the week.



WEEKENDER

The hot tub will be in economy mode from Monday to Friday, and will run normally on the weekend.

MODIFYING WATER CARE SCHEDULES

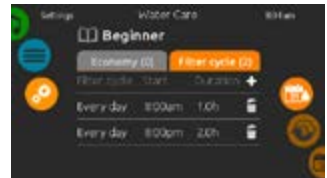
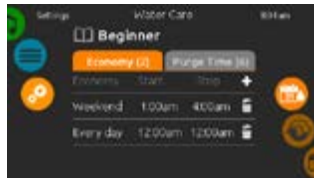

WATER CARE

To modify a Water care category, touch the pen icon at the right end of the desired water care to open the selected Water Care menu.

ECONOMY

Touch the Economy tab to change the economy schedule. You can add economy schedules by touching the « + » symbol . To delete a schedule, touch the garbage can icon at the right end of the desired line.

FILTER CYCLES

Touch the Filter cycle tab to change the filter cycle schedules. You can add filtration schedules by touching the « + » symbol . To delete a schedule, touch the garbage can icon at the right end of the desired line.

MODIFYING WATER CARE SCHEDULES



In Economy mode, the set point will be reduced by 20°F, which means that the heating system will not be engaged unless the temperature falls to 20°F below the hot tub's set temperature.

The filtration schedule shown on the screen will apply to the main filtration pump, most likely pump 1. If your hot tub uses a circulation pump configured to run 24 hours, the screen will show you the purge setting instead of filtration. The purges are pre-programmed for a fixed number of minutes, therefore the duration will be set to N/A on the screen, and only the start time can be modified.

You can modify the programmed schedules by selecting one and adjusting the schedule.

You have several possibilities for the schedule (Mon-Fri, weekend, every day, or single days). The schedules will be repeated every week. The time and duration are set in 30 minute increments.

Once you have set the schedule, use the calendar icon to go back.



PURGES

Touch the Purge tab to change the purge settings. You can add purges by touching the « + » symbol.

To delete a schedule, touch the garbage can icon at the right end of the desired line.

You can modify the programmed purges by selecting one and adjusting the schedule.

You have several possibilities for the schedule (Mon-Fri, weekend, every day, or single days). The schedules will be repeated every week. The time and duration are set in 30 minute increments. Once you have set the purge, use the calendar icon to go back.

MAINTENANCE & ERROR LOG

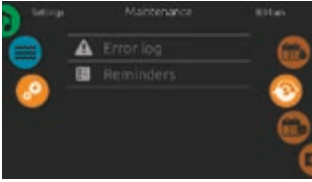

MAINTENANCE

To modify maintenance settings, slide the right wheel until the maintenance icon is highlighted in the middle.

From the Maintenance page you can access the following:

- Error log
- Reminders

Simply touch the line of the item you want to change.



ERROR LOG

Errors are archived by the system. Drag the list Up and Down to move through the list. Errors are archived chronologically, from the most recent at the top to the oldest at the bottom.

The Error log page shows the error code, the date of the error, and the time.

Touching the garbage can icon will delete the Error log (with a confirmation).

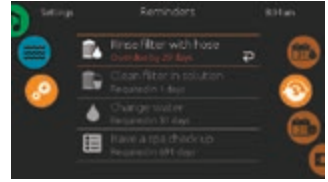

REMINDERS

Smart Touch keypad will provide reminders about maintenance required on your hot tub, like rinsing or cleaning the filter. Every task has its own duration, based on normal use.

The reminders menu allows you to check the time left before maintenance is required, as well as to reset the time once a task has been completed.

To reset a task, select it by pressing the curved arrow, then confirm when prompted. Once you have confirmed, the task will be reset.

DATE AND TIME

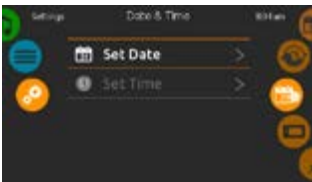

DATE AND TIME

To modify date and time settings, slide the right wheel until the date and time icon is highlighted in the middle.

Simply touch the line of the item you want to change.

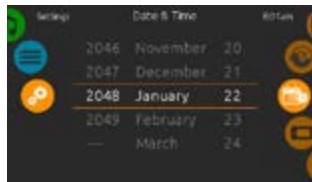

SET DATE

Here you can adjust the year, month and date. Simply swipe up and down the column you want to change, and select the desired value. When done, touch the calendar icon at the right of the screen.



SET TIME

Here you can change the hour, minute and time format. Simply swipe up and down the column you want to change, and select the desired value. When done, touch the calendar icon at the right of the screen.

KEYPAD SETTING

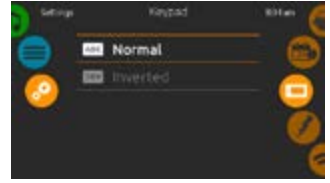

KEYPAD SETTINGS

To modify keypad settings, slide the right wheel until the keypad icon is highlighted in the middle.

Simply touch the line of the item you want to change.

TEMPERATURE UNITS

Use this page to set or change the temperature in F° or C° units.

DISPLAY ORIENTATION

Use this page to set or change the normal or inverted display orientation.

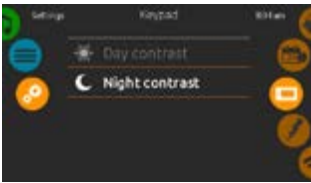

DISPLAY CONTRAST

Use this page to set or change the display day or night contrast.

DISPLAY LANGUAGE

Use this page to set or change the display language.

KEYPAD LOCK/UNLOCK (OPTIONAL)

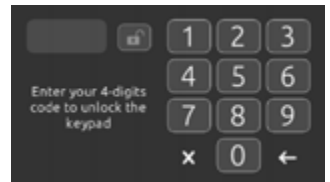
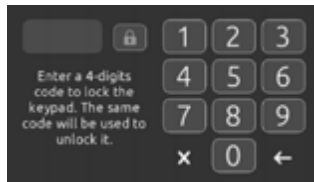
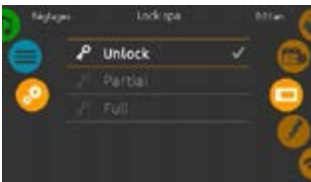

When this option is enabled, the user can partially or completely lock the keypad. When the user wants to lock the keypad he is asked to select a 4-digit code. The same code will be needed to unlock the keypad. Next time he wants to lock the keypad, he will be prompted again to select a 4-digit code (same functionality as a Safe in a hotel room).

The keypad can be unlocked with a universal unlock code (3732) or by a reset of the keypad.

When Full Lock is selected, all functions are locked.

In Partial Lock, you may only activate accessories. Settings may not be changed in this mode.

KEYPAD COLOR (OPTIONAL)



If this option is available (depending on the hot tub configuration), the keypad rim color can be changed. 8 pre-defined colors are available. If the in.mix is installed, the keypad rim color can also be associated to an in.mix zone.

WIFI

(This function is available only if an in.touch module is connected to your system.)



WIFI SETTINGS

To modify wifi network settings, slide the right wheel until the wifi icon is highlighted in the middle.

WIFI NETWORKS

After a few seconds the available networks will appear on the screen, as well as their signal strength.

Selected network will be identified by a green check mark.

Swipe Up or Down the list to select your network.

WIFI NETWORK PASSWORD

If the wifi network is password protected, enter it when keyboard prompts. Use Enter key to validate the password.

If no password is required the in.touch will connect automatically.

WIFI



IN.TOUCH MODULE NOT CONNECTED

If the in.touch module of your hot tub system is not connected, this message will be displayed.

WI-FI (IN.TOUCH 2)



When an in.touch 2 is detected, this network will appear.

MISCELLANEOUS

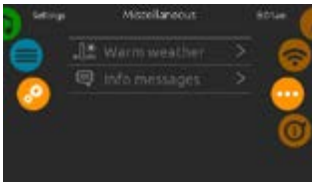

This menu gives access to modify the Warm Weather option and info messages in the media center.

WARM WEATHER



The Warm weather option allows you to bypass the pack filtration over-temperature feature. When Warm weather is Off, the filtration over-temperature is disabled. This feature allows the hot tub to continue filtering even though the water temperature is high.

INFO MESSAGES



When pumps are running, they produce heat that may increase your water temperature. "Warm Weather" option gives you the option to bypass the pack filtration over-temperature feature. When Warm Weather is "OFF" the filtration over-temperature is disabled and your hot tub filtering will continue even if the water temperature is high.

ABOUT



This section shows information about the in.k1000 software number and the revision numbers of the different components of your system.

ELECTRICAL CONFIGURATION



Please do not make changes in this section unless you are a qualified electrician.

A password will be required. Please contact a representative in order to obtain that password.

To change the low-level configuration, the number of phases and the input current of your hot tub system, slide the right wheel until the electrical configuration icon is highlighted in the middle.

AUDIO MODE

(only available if the system detects a connected Aquasoul Pro audio station)

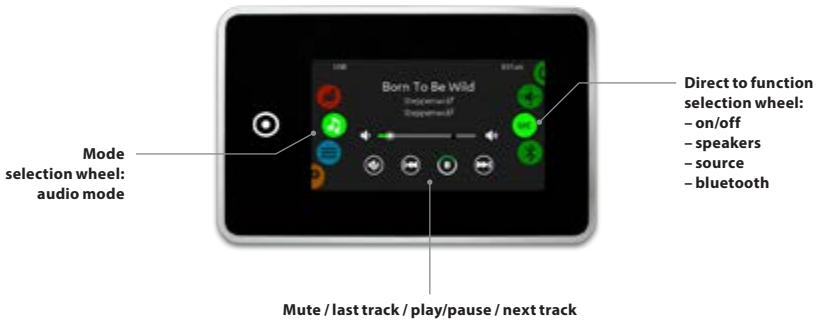

To select the audio mode, slide the left wheel up or down until the audio icon menu is highlighted in the middle.

In the Audio page you can access the following:

- Aquasoul Pro on/off
- speaker calibration
- audio source selector
- bluetooth pairing

To select an item, slide the right wheel until the desired icon is highlighted in the middle.

ON/OFF



TURN AQUASOUL PRO ON

Slide the right wheel until the power on/off icon is highlighted in the middle. Press on the audio icon at the center of the screen to turn Aquasoul Pro on.

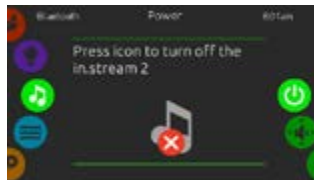

TURN AQUASOUL PRO OFF

Press on the audio icon in the center of the screen to turn Aquasoul Pro off.

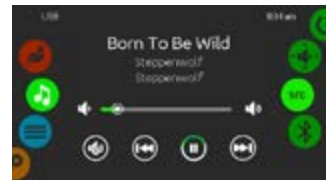

MAIN DISPLAY

Press Play / Pause to start or pause playback of audio files.

Drag the volume slider to adjust the volume or tap the mute button to mute or unmute sound.

Press the last track or next track buttons to go to the previous song or skip to the next.

SPEAKER CALIBRATION



TO CALIBRATE YOUR SPEAKERS

Slide the right wheel until the speaker calibration icon is highlighted in the middle.

You can calibrate:

- balance
- fade
- subwoofer

Use the sliders to calibrate the speakers at the desired level.

The fade and subwoofer sliders will only appear on the screen if the corresponding speakers are installed on Aquasoul Pro.

AUDIO SOURCE SELECTOR

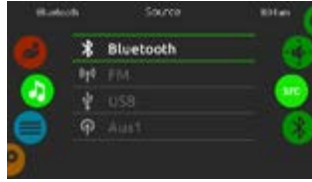

TO SELECT AN AUDIO SOURCE

Slide the right wheel until the source icon is highlighted in the middle.

In the menu list, the following sources are available:

- Bluetooth
- FM
- USB
- Aux. 1

Simply select the desired one to use.

Note that only the sources installed on Aquasoul Pro will be displayed in the source menu.

Please note that the Play/Pause and Change Track functions apply to devices using Bluetooth technology and USB, and will not work when AUX is selected as the source.

Please refer to the Aquasoul Pro connexions section to learn how to connect your Bluetooth device.

BLUETOOTH PAIRING

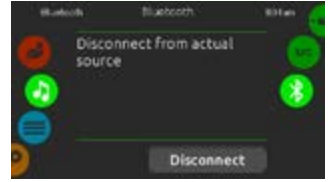

If you are using a device with Bluetooth technology, it must be connected for functions to work.

Slide the right wheel until the bluetooth icon is highlighted in the middle. Then follow the instructions displayed on the screen.

If a device with Bluetooth technology is connected to Aquasoul Pro, you can disconnect it by pressing the Disconnect button at the bottom of the screen.

Doing so will also prevent Aquasoul Pro from automatically reconnecting to this specific device until it has been reconnected using the device itself.

TOO MUCH WATER ON DISPLAY



WIPE SCREEN

This message appears when too much water is detected on the touch screen. Simply wipe away excess water.

INSTALLATION ERROR MESSAGES

Upon connecting Smart Touch to your hot tub system you may see one of two error messages. Please follow the instructions in the message or contact your dealer for more information.

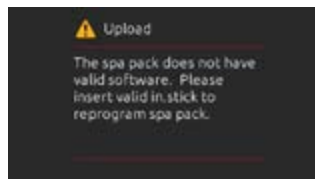

Error messages on the screen list and definitions:
<http://geckokeypads.com/k1000errormessages>

SMART WINTER MODE (SWM)

There is a thermometer sensor in the control unit that measures the temperature of the machinery. It monitors how cold it is outside the cover - including the insulation - and turns on the motors from time to time to direct hot water into the machinery to avoid freezing.

The SWM (Smart Winter Mode) will not turn on if the sensor measures above 21C. However, if it falls below that, it will turn on for 24 hours.

- if it measures 20-16 degrees, it will run the motors for 1 minute every 2 hours.
- if it measures 15-13 degrees, it will run the motors for 1 minute every hour.
- if it measures 12-11 degrees, it will run the motors for 1 minute every 30 minutes.
- if it measures 10 degrees (or less), it will run the motors for 1 minute every 15 minutes.

This is a safety function which cannot be turned off!

WARM WEATHER FUNCTION

During the filtration cycle, the kinetic heat generated by the circulating motors is transferred to the pool water, so the pool water temperature can possibly rise above the set temperature on the control panel. The control unit continuously monitors the water temperature during the filtration cycle and if it rises above the set temperature by more than 3 degrees celsius, it automatically shortens the duration of the filtration period so the water does not overheat.

Besides continuously measuring the water temperature, it automatically changes the duration of the filtration period, but filters for at least 4 hours if the spa is equipped with a circulating motor, or for at least 2 hours if the water is filtered by the massage motor.

This function can only be turned off on whirlpools equipped with a colour touch screen.

OPTIONAL ACCESSORIES - MY MUSIC

MY MUSIC

NO EXTERNAL CONTROL UNIT



1. Listening to music via Bluetooth

1.1 Pairing Bluetooth devices

1. Turn on the Bluetooth device
2. Select ProwBT/MyMusic from the available devices and pair it (no password needed). Only one Bluetooth device can be paired with the Bluetooth Media Player at a time.

1.2 Listening to music via Bluetooth device

1. The Bluetooth mode is activated as soon as it is paired with a Bluetooth device.
2. Play music on the device and the Bluetooth Media Player will provide the sounds.
3. Press the PLAY/PAUSE buttons to play or pause the music.
4. Press the FAST REWIND/FORWARD buttons to play the previous/next track.
5. The songs/tracks and volume can be set directly on your Bluetooth device or with a remote control.

We would like to inform you that the new 2.0 speakers require a PIN for connection. The PIN number is: 2288

OPTIONAL ACCESSORIES - UV-C / OZONE

UV-C WATER TREATMENT

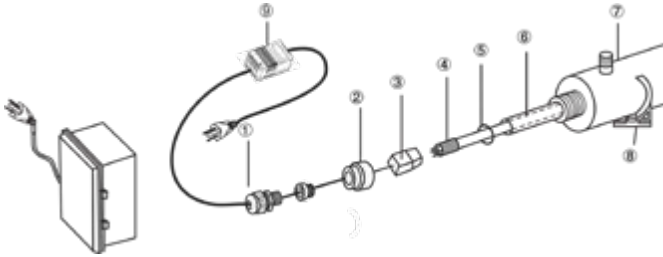

- 1- Water resistant lid
- 2- Aluminum nut
- 3- Lamp casing, wire outlet
- 4- Germicidal ultraviolet lamp
- 5- Rubber sealing ring
- 6- Quartz sleeve
- 7- Chamber
- 8- Pawl
- 9- Transformer

WARNING: THE GERMICIDAL ULTRAVIOLET RAYS ARE HARMFUL TO THE EYES, SKIN.

INTEGRATION:

1. Install the sterilization equipment at an easy to reach well lit place for effortless observation and maintenance.
2. Lock the clamp on the frame.
3. Insert the chamber with the help of the clamps.
4. Connect to the water supply.
5. Insert the quartz sleeve, sealing ring, lamp.

IMPORTANT: DO NOT TOUCH THE QUARTZ SLEEVE OR THE SIDES OF THE LAMP, ONLY HOLD IT BY THE TWO ENDS.

The ultraviolet lamp and the quartz can easily be damaged. Take care when removing or changing the lamp or the quartz sleeve.

- a. Take off the nut. (2).
- b. Carefully slide the quartz sleeve (6) from one end of the chamber to the other.
- c. Slide the sealing ring (5) onto the free end points of the quartz sleeve.
- d. Squeeze the aluminum nut on by hand (2).
- e. Slide the lamp (4) into the quartz sleeve.
- f. Connect the lamp to the casing.
- g. Screw the nut to the chamber, then screw on the water resistant lid (1) to the nut (2).
- h. Open the tap and check if the device is leaking. Repair as necessary.
- i. Plug the device into the electric supply. Use a socket equipped with a fault circuit interrupter (GFCI).

Malfunction of the UVC water sanitizer is indicated by the LED logo flashing in red. In this case, replacement of the fluorescent tube is necessary.

CHANGING THE LAMP AND SERVICING THE UV SYSTEM

Important: Do not touch the quartz sleeve or the sides of the lamp, only hold it by the ends.

1. Unplug the power plug.
2. Shut down and drain the water from the device to lessen pressure.
3. Take off the PVC lid (1) and unscrew the aluminum nut (2).
4. Carefully pull out the lamp (4) to approximately 5cm from the chamber (7).
5. Holding the lamp by the end carefully remove the lamp casing (3) on the free end.
6. Carefully take the lamp out of the chamber.
7. Carefully take off the sealing ring (5) from the end of the quartz sleeve.
8. Carefully take off the quartz sleeve.
9. To reinstall follow instructions 1 to 8 in reversed order

MAINTENANCE SUGGESTION:

In order for the sterilizer to work properly and with maximal efficiency the user should perform the following maintenance tasks.

1. Cleaning, changing the quartz sleeve:
 - a) The quartz sleeve is to be cleaned with a glass cleaner solution every 6-12 months.
 - b) The quartz sleeve is to be changed every 24 months.
2. Changing the UV lamp is recommended after 8-9000 operating hours (about 12 months of continuous operation).
3. To acquire interchangeable parts contact our headquarters or the local representatives of our company.

OZONE DISINFECTION

FILTRATION AND OZONE

In a system without circulation engines the low setting of the massage engine and the ozone generator will switch on during filtration. In a circulation type system ozone starts in a system with circulation engine.

The system is factory programmed for an evening filtration cycle since energy prices might be lower in the evening (assuming that the time of day is properly set). The filtration time and duration are programmable.

A second filtration cycle can be freely entered.

At the start of every filtration cycle the jets and engine start to clean the pipes and ensure proper water quality.



OPTIONAL ACCESSORIES - IN.TOUCH 2

HOME TRANSMITTER (EN MODULE) INSTALLATION

The Home Transmitter unit must be installed inside the house near the router as it needs to be connected to it. The Home Transmitter is provided with an Ethernet cable and a power supply. If required, a longer cable of good quality can be used by the installer (longer cable not provided) to install the Home Transmitter closer to the hot tub within the home.

The only requirement for installation location is that household current be available to power the Home Transmitter using the provided wall transformer.

The Home Transmitter can be fixed in the house to optimize the signal strength. We recommend that you install the unit with a #8 pan head screw.

Here are some suggestions for a successful installation:

- If possible, install device on the first floor of your house.
- If installing in a basement, place at highest level possible and closest to a window.
- Try to install as far as possible from materials that may interfere with signal (ie. metal structures, thick cement walls).
- Install as far as possible from router as the signal emitted by the antenna may interfere with RF signal.

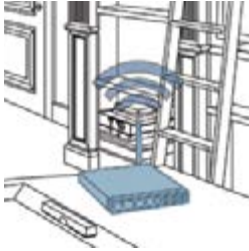

CONNECTION OF THE HOME TRANSMITTER (EN MODULE)

Simply connect Ethernet cable into the RJ45 port of the Home Transmitter and in one of the available LAN ports on the router.

Finally, to power up the Home Transmitter, connect the provided transformer to a 120V (North American model) or 220V (European model) household supply and connect the USB cable between the transformer and the Home Transmitter.

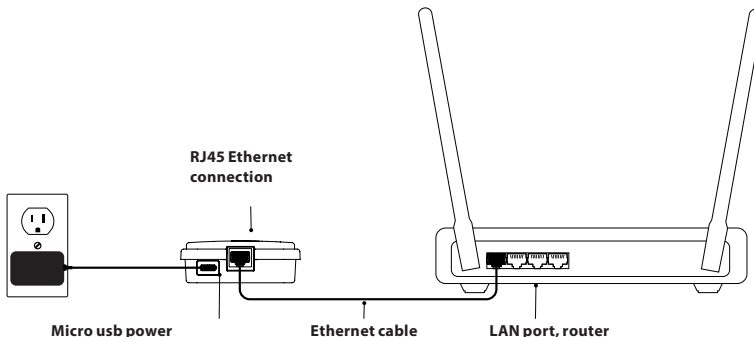

OPTIONAL ACCESSORIES - IN.TOUCH 2

PAIRING THE HOT TUB TRANSMITTER (CO MODULE) AND THE HOME TRANSMITTER (EN MODULE)

The pairing process is used when you need to replace one module of the in.touch 2 kit. Otherwise, the in.touch 2 arrives pre-paired from the factory.

1. Power up the Home Transmitter

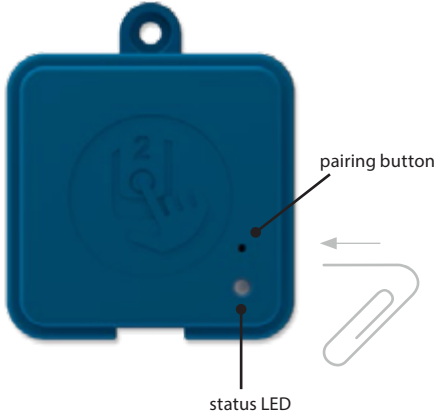

2. Press on the pairing button with a paper clip or some similar tool. When the pairing mode is active the status LED flashes YELLOW in a rapid pattern. The Home Transmitter is then in pairing mode and will remain in this mode until it pairs with a Hot tub Transmitter, or until it is reset (power cycled).

3. Shut off the hot tub's breaker (thus turning off the Hot tub Transmitter), wait a few seconds, and then flip the breaker back on. Within a few seconds, the pairing operation should complete and the Home Transmitter status LED will no longer be YELLOW.

Note: in.touch 2 modules can be paired as often as necessary, but can only be paired with a single counterpart module at a time. Once paired, the modules store this information permanently until the next pairing operation. Pairing information is stored in non-volatile memory, so pairing is not required after a power failure. Only a Home Transmitter can initiate a pairing, so it is important that the pairing begin with putting the Home transmitter module in pairing mode.

If several hot tubs are powered up at the same time with a Home Transmitter in pairing mode (for instance, in a dealer showroom), only the 1st hot tub to successfully connect to the Home Module will pair. As this can be random, it is recommended that only 1 hot tub be powered up at a time during the pairing process.

OPTIONAL ACCESSORIES - IN.TOUCH 2

LED

Each in.touch 2 module has a status LED that can be used for troubleshooting purposes. The LED is located on the top of both enclosures.

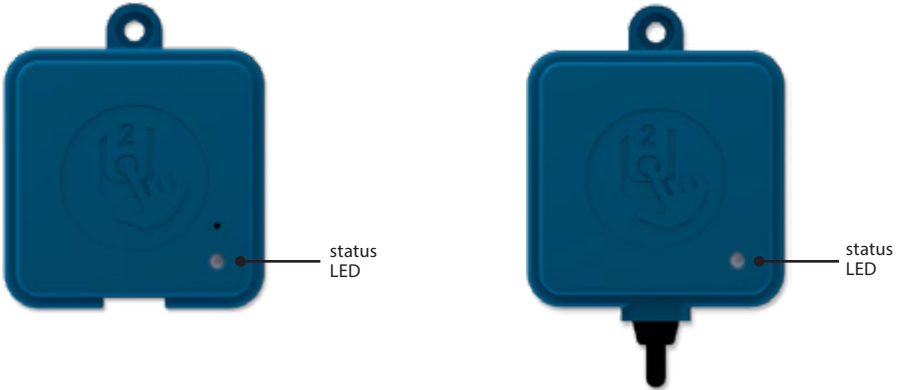

Home Transmitter

Pairing mode Yellow (Blinking)	●
Router not detected	●
Router detected	●
in.touch 2 server detected	●
Module is fully functional	●

Hot tub Transmitter

Pairing mode Yellow (Blinking)	●
Hot tub controller not detected	●
Red	●
in.touch 2 server detected	●
Module is fully functional	●

* When the LED status is blinking (blue, green or red) this indicates that the communication between the EN module and the CO module is not established.

OPTIONAL ACCESSORIES - IN.TOUCH 2

DOWNLOAD APPLICATION

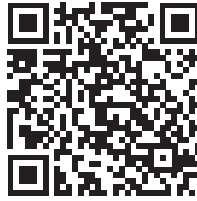

The in.touch app allows you to control your spa using your home network or an Internet connection anywhere in the world. The Wellis Spa Control (in.touch 2) app is waiting for you in the App Store for iOS devices and on Google Play for Android — search for «Wellis Spa Control» then click on it to install.

USE THIS APP

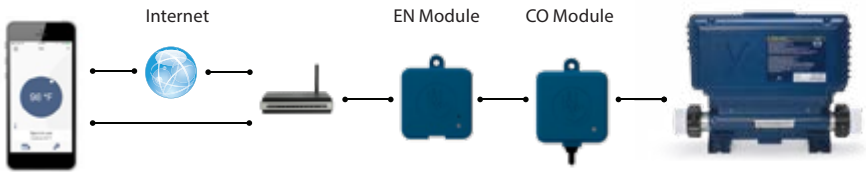

ON YOUR HOME NETWORK

It is possible to access your hot tub with the in.touch 2 app through your home network. To be able to see your in.touch 2 in the application you need to connect your device to the same router (Wi-Fi network) than the one used to connect your Home Transmitter

Go to the Wi-Fi settings section of your mobile device and choose the same network that your hot tub is connected to (i.e. Home). Once you've selected it, wait until your device confirms the connection.

ON THE INTERNET

The in.touch 2 allows you to use the Internet to control your hot tub from anywhere in the world. In order for them to communicate, both the in.touch 2 module and your device must be connected to a network that allows access to the Internet.

Once your Home Transmitter is connected to the Internet (the LED status is blue), you can use your in.touch 2 app any time your device is also connected to the Internet (wireless or cellular network), even if you are away from home.

To have access to your hot tub away from home, you will need to have previously linked your mobile device to your hot tub on your home network.

SETUP YOUR WI-FI ON YOUR DEVICE

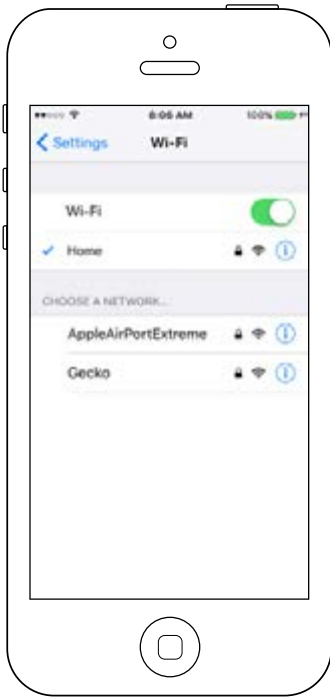

Before using your application, go to the Wi-Fi section of your device's settings. Make sure you are connected to your home network. This needs to be the same Wi-Fi provided by the router to which you connected your Home Transmitter.

OPTIONAL ACCESSORIES - IN.TOUCH 2

START THE IN.TOUCH 2 APPLICATION

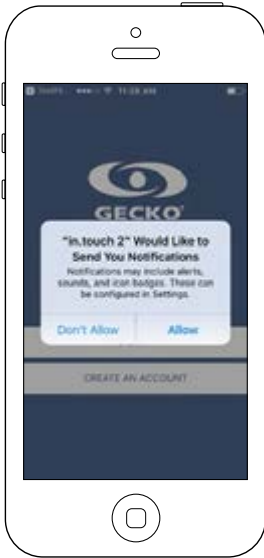

Find the icon for the in.touch 2 application, then tap on it to open it.

The first time you use the application a message will ask you: "in.touch 2" Would like to send you notifications. If you choose Allow, the application will send you notifications about the status of your hot tub. If you choose Don't Allow, the application will not send you notifications.

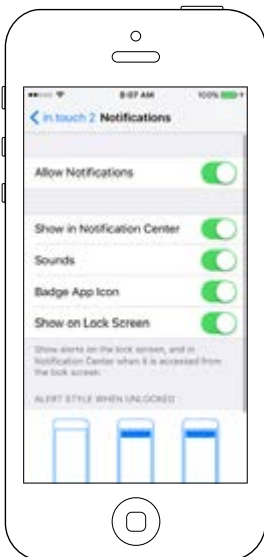

If you change your mind later concerning notifications, you may add or remove notifications for the in.touch 2 application.

On iOS, go in your settings menu and choose in.touch 2. Select the notifications menu, you can turn notifications on or off from this page.

On Android, go to your settings menu and then into the notifications menu. Select the in.touch 2 app, from this page you may turn notifications on or off.

LOGIN PAGE



Before using your application, you must create an account first and then, you'll be able to sign in. Your account will give you the opportunity to have access to your hot tub from any in.touch 2 application.

NEW ACCOUNT CREATION



When you choose to create a new account, you agree at the same time our Terms of Service and our Privacy Policy. You can read them at any time through this link:

<https://geckointouch.com/legal>

OPTIONAL ACCESSORIES - IN.TOUCH 2

CHOOSE A SPA

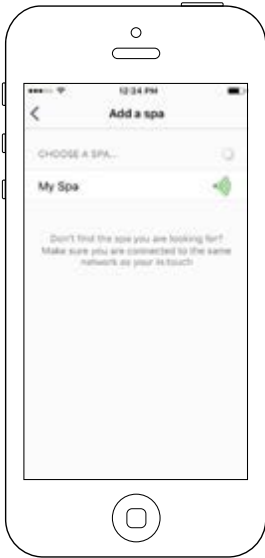





This page displays all the hot tubs detected by your application.

To detect your hot tub, you need to connect your mobile device to the same network to which you connected your Home Transmitter.

Once you have done a connection with the hot tub its name will be saved on this page to allow you to connect to this hot tub from anywhere.

To add a hot tub later on, go to p. 26 of this techbook for instructions. The RF signal strength (communication between the two in.touch 2 transmitters) is illustrated on the Select a spa page. There are 5 possible states:

-  • Signal superior to 80%
-  • Signal between 80% and 51%
-  • Signal between 50% and 31%
-  • Signal below 30%
-  • The Hot tub Transmitter is not available

HOME PAGE

The main screen gives you access to your accessories, water temperature, water care and settings.



OPTIONAL ACCESSORIES - IN.TOUCH 2

SPA STATE



This page displays all the active states of your hot tub. Below is a quick description of each state you may encounter on your hot tub. Each state is associated to a priority and color that determines the color of the widget on the home page.

- Indicates that there is an error on your hot tub.
- Indicates that there is presently an active user demand on your hot tub (ie. pump, blower or light is on).
- Indicates that your hot tub is now heating to your set point.
- Indicates that your hot tub is now in a filtering cycle.
- Indicates that your hot tub is now in economy mode.
- Indicates that your hot tub is running normally (there is no user demand, heating, no filtration or economy active).

The widget on the home page displays a single color at a time. The color displayed is decided by priority of state. The established priority is as listed above.

CHANGE TEMPERATURE

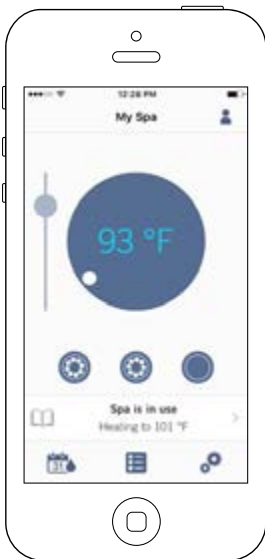

Touch the centered widget to reveal the temperature control bar.

Use the slider on the control bar to change your hot tub's temperature* set point.

** If you are in economy mode your hot tub temperature will be 20°F below your set point.*

OPTIONAL ACCESSORIES - IN.TOUCH 2

TURN ON/OFF ACCESSORIES



According to your hot tub pack configuration, you can start or stop an accessory by simply touching the associated icon. The icon will become animated when the accessory is on. Simply press on the icon to start or stop the accessory.

If your accessory has more than one speed, press the button until the desired speed is reached.

The icon designs are customized according to your hot tub pack configuration:



Pump



Waterfall



Blower

TURN ON/OFF THE LIGHTS



To control your hot tub lights, simply press the button to turn it on or off

OPTIONAL ACCESSORIES - IN.TOUCH 2

CONTROL YOUR IN.MIX 300

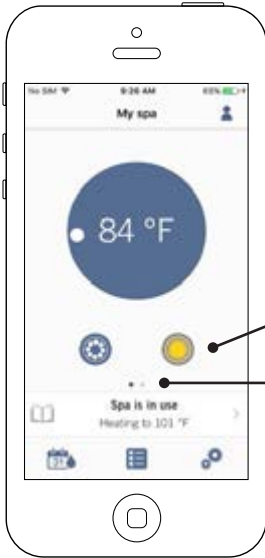

This menu is only available if an in.mix 300 is detected in your hot tub accessories

To turn on or off the in.mix 300, you can use, if you want, the light icon on your home page. To go to your in.mix 300 page, simply swap to the left.

Turn on/off in.mix 300

Swap to in.mix 300



Color wheel

Rainbow icon

Synchronization/
desynchronization
icon

On

Intensity

Off

Zone selection

The in.mix 300 page allows you to customize your color zones in or around your hot tub.

The light bulb icons allow you to turn on and off your in.mix 300.

To select a zone, click on the wanted one in the "zone selection" stripe. To change the color, use the color wheel to choose the one you want. On the left side, the intensity slider allows you to modify the brightness of your lights. Use the rainbow icon to get color gradation.

The synchronization / desynchronization icon gives you the possibility to match the color of the selected zone with the other zones

WATER CARE

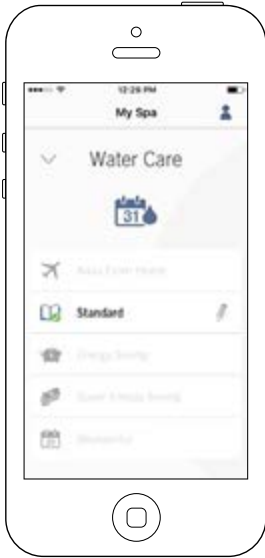

The Water Care page will help you set up your ideal filtration and heating settings. Choose between Away from Home, Beginner, Energy Savings, Super Energy and Weekender, depending on your need. Touch the Water Care name you would like to activate, a green checkmark will appear on the icon, indicating you have selected it.

By default, each Water Care mode has pre-configured schedules of economy and filtration. To modify Water Care options, touch the pencil icon at the right end of the desired Water Care to open its menu.

Below you have a short description of each Water Care at default state:



Away From Home:

In this mode the hot tub will always be in economy; the set point will be reduced by 20° F.



Beginner / Standard:

The hot tub will never be in economy mode and will be filtering according to the pack's low level configuration.



Energy Savings:

The hot tub will be in economy mode during the peak hours of the day and resume normal mode on the weekend.



Super Energy Savings:

The hot tub will always be in economy mode during peak hours, every day of the week.



Weekender:

The hot tub will be in economy mode from Monday to Friday, and will run normally on the weekend.

REMINDERS

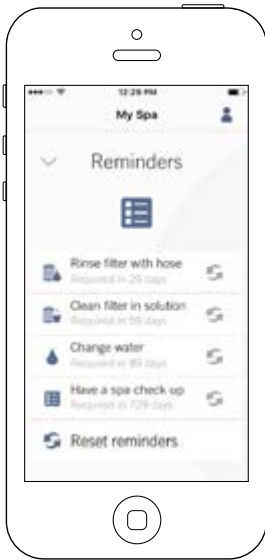

Reminders page will help you to make a follow-up of your maintenance.

The in.touch 2 will remember you to perform required maintenance tasks on your hot tub, such as rinse filter or clean filter. Each task has its own reminder duration based on normal use. The owner can reset his reminders after the hot tub maintenance.

OPTIONAL ACCESSORIES - IN.TOUCH 2

MODIFYING SCHEDULES



In this menu it is possible to add, remove or edit schedules of economy or filtration.

To have access to this menu, simply touch the tabs:

Water Care menu - the little pen at the right of the wanted water care

Touch the Economy tab to modify the economy schedules and Filter cycle tab for the filtration schedules. You can add economy or filtration schedules by touching the « + » symbol.

To delete a schedule, touch the garbage can icon at the right end of the desired line.

You can modify the programmed schedules by selecting one and adjusting the schedule.

You have several possibilities for the schedule (Mon-Fri, weekend, every day, or single days). The schedules will be repeated weekly. The time and duration are set in 30 minute increments. Once you have set the schedule, use the arrow at the top of the page to go back. Ensure that you have selected the desired Water Care mode in the main Water Care menu.

When an economy schedule is active, the set point will be reduced by 20°F, which means that the heating system will not be engaged unless the temperature falls to 20°F below the hot tub's set temperature.

The filtration schedule is applied to the main filtration pump, most likely pump 1. If your hot tub uses a circulation pump configured to run 24 hours, the screen will show purge schedules instead of filtration. The purges are pre-programmed for a fixed number of minutes, therefore the duration will be set to N/A on the screen and only the start time can be modified.

OPTIONAL ACCESSORIES - IN.TOUCH 2

SPA SETTINGS

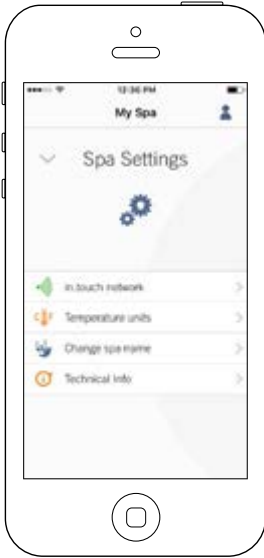

In the Settings page you can access the following:

in.touch network
Temperature units
Change spa name
Technical info

To select an item, tap on the arrow next to it. It will open the selected menu.

IN.TOUCH NETWORK

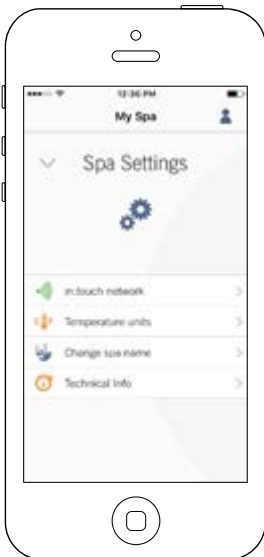

The in.touch network menu allows you to have access to information concerning the RF connection parameters between the Home Transmitter and the Hot tub Transmitter. This menu gives you access to:

Channel
Signal strength
Reset channel (resets channel to ... default)

To change channels, press on the Channel line.

OPTIONAL ACCESSORIES - IN.TOUCH 2

CHANGE CHANNEL



The Change channel page allows you to change the channel used by the two in.touch 2 modules.

In some cases, this can help you to have a stronger signal.

You can have access to this page by touching the following tabs: Spa settings (at the bottom right) - in.touch network - channel

TEMPERATURE UNITS

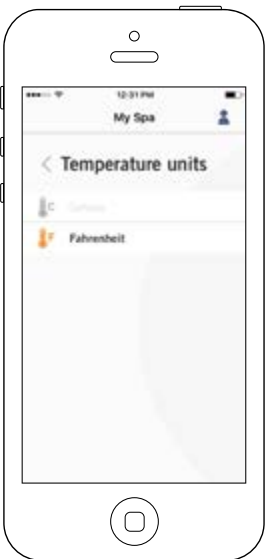

This menu lets you change the units used to display temperature.

You can have access to this page by touching the following tabs: Spa settings (at the bottom right) - temperature units.

OPTIONAL ACCESSORIES - IN.TOUCH 2

NAME



This section allows you to edit the name of the hot tub.

You can have access to this page by touching the following tabs: Spa settings (at the bottom right) - Change hot tub name

TECHNICAL INFO



This section shows information about the in.touch 2 software number and the revision numbers of the different components of your system.

You can have access to this page by touching the following tabs: Spa settings (at the bottom right) - Technical info

SETTINGS

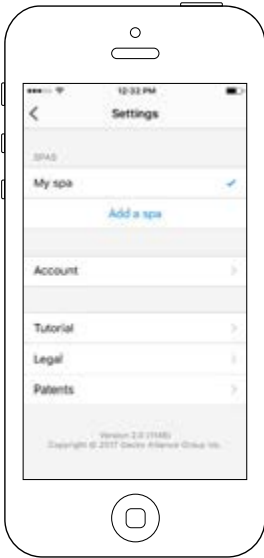

In the Settings page you can access the following:

- Add a hot tub from local network*
- Account*
- Tutorial*
- *Legal*
- **Patents*

To select an item, tap on the arrow next to it. It will open the selected menu.

*The button Legal will bring you to this web site :
<https://geckointouch.com/legal>

**The button Patents will bring you to this web site:
<http://geckoportal.com/corpo/#patents>

ADD A SPA







This page displays all the hot tubs detected by your application.

To detect your hot tub, you need to connect your mobile device to the same network to which you connected your Home Transmitter.

Once you have done a connection with the hot tub its name will be saved on this page to allow you to connect to this hot tub from anywhere.

You can have access to this page by touching the following tabs: Settings (up right corner) - Add a spa

The RF signal strength (communication between the two in.touch 2 transmitters) is illustrated on the Select a hot tub page. There are 5 possible states:

-  • Signal superior to 80%
-  • Signal between 80% and 51%
-  • Signal between 50% and 31%
-  • Signal below 30%
-  • The Hot tub Transmitter is not available

ACCOUNT



This section gives you access to your account information.

You can have access to this page by touching the following tabs: Settings (up right corner) - account

TUTORIAL



This section gives you a quick overview of your in.touch 2 application's functions.

OPTIONAL ACCESSORIES - IN.TOUCH 2

TECHNICAL SUPPORT INVITATION



When you receive an invitation for Technical Support, a red circle will be displayed next to the "setting" logo (top right corner).

AUTHORIZING AN INVITATION

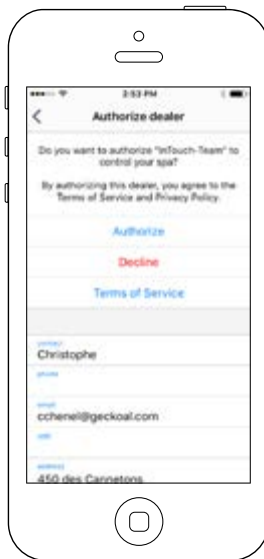
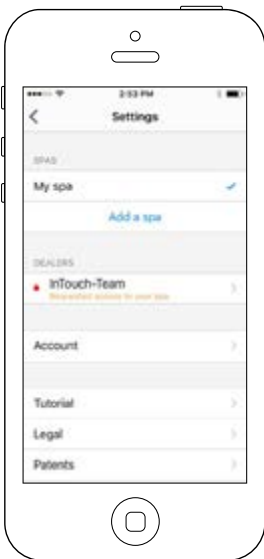

All the invitations you may receive are under the dealers tab in the "settings" menu.

To choose an invitation, simply click on it. You will then see a window authorization to confirm with the dealer's information.

You can also decline the invitation at any time if you want to.

OPTIONAL ACCESSORIES - IN.TOUCH 2

DEALER PAGE



Once you've had a dealer on your in.touch 2 app, you can, at all times, have access to his information.

If you don't want your dealer to have access to your hot tub anymore, simply swap to the left the "Allow access to your spa" button at bottom of the page.

Both in.touch 2 modules have a status LED to help diagnose problems, if any occur.

TROUBLESHOOTING

There are 2 different modules in the in.touch 2 kit: The Home Transmitter (EN Module) and the Hot tub Transmitter (CO Module). They communicate together via an RF link. The Home Transmitter is responsible for the Ethernet communications and the Hot tub Transmitter is responsible for the hot tub communications.

OPTIONAL ACCESSORIES - IN.TOUCH 2

HOME TRANSMITTER (EN MODULE) LED STATUS

This module's LED can show various status conditions, as indicated below.

Rapidly flashing YELLOW color:

The Home Transmitter is in pairing mode when this color is shown (the pairing switch was pressed). Until a pairing successfully completes, the application cannot connect to the hot tub. To complete the pairing, you must turn off the hot tub (using its breaker), wait a few seconds and then flip back the breaker to on. The pairing will then occur within a few seconds. If not, then the Hot tub Transmitter is either incorrectly connected, out of range, or defective.

If the in.touch 2 modules were previously paired and the pairing switch is accidentally pressed, simply unplug the Home Transmitter USB power cord and re-plug it (thereby resetting the Home Transmitter). The modules should then normally reconnect together.

Once out of pairing mode, the Home Transmitter will display another color.

For each of the following colors, the information applies whether the LED is blinking or not. If the LED is blinking, please also refer to the Blinking LED section below.

RED color:

Reason?

The Home Transmitter is not detecting a router. Until this is resolved, the application cannot connect to the hot tub.

What to do?

Make sure the router is powered and working correctly (i.e. test it using another computer or device connected to the same LAN port you intend to use).

Make sure the Ethernet cable is correctly connected at each end (LAN port on router end, and the Home Transmitter.)

If the problem still occurs, try connecting with another cable. If a computer (or other device) works fine on the LAN port, and the cable is fine, then the Home transmitter is likely defective.

GREEN color:

Reason?

The Home Transmitter is connected to a router (an IP address was assigned), but the in.touch 2 server is not reachable.

What to do?

This is very likely a router configuration issue, so refer to your router's User Manual.

It may be due to Port 10022 being closed. Normally, this port is open by default in commercial routers, but different routers may have different behaviors.

If Port 10022 is confirmed as open, then some other internal configuration is preventing the router from accessing Internet. In this case, the application will still have access to the hot tub if connected to the same network.

The server may also simply be temporarily "offline" for servicing/maintenance, so try again later. The application can still connect with the hot tub, but only from within the same network.

If the application can connect to a local hot tub, the problem is likely the Internet connection (WAN), a router mis-configuration, or your Internet Service Provider (ISP) has issues with its network connection.

BLUE color :

Reason?

This is the normal state of the Home Transmitter LED.

It has a full Internet connection, with access to the in.touch 2 server. As long as your device and application have access to the Internet (either via Wi-Fi or cellular data such as 3G, 4G, or LTE), then you're good to go!

What to do?

Enjoy your hot tub!

OPTIONAL ACCESSORIES - IN.TOUCH 2

HOT TUB TRANSMITTER (CO MODULE) LED STATUS

This module's LED can show various status conditions, as shown below.

Rapidly flashing YELLOW color:

The Hot tub Transmitter is in pairing mode when this color is shown. This normally briefly occurs automatically during power-up of the hot tub (i.e. right after the breaker is flipped on). This could also occur if the Hot tub Transmitter was never paired (which is very unlikely, as they are shipped paired from factory). Refer to the pairing section if your unit has not been paired, so you may complete the process.

BLUE color:

Reason?

This is the normal state of the Hot tub Transmitter LED. If the Hot tub Transmitter also shows solid blue, you are all set! If this LED is blinking, refer to the Blinking LED section below.

What to do?

Enjoy your hot tub!

Blinking LED:

On both modules, if the LED is blinking about once per second, it means that the RF link is not established between them (i.e. each in.touch 2 module cannot communicate with its counterpart). This can occur for several reasons.

Review the following and perform the tests in the order given below.

Unpaired:

As the modules are shipped paired from the factory, this is not a likely cause, but it is the easiest test to perform in the field. Simply attempt to pair them again. Please refer to the Pairing section for instructions on pairing.

Modules out of range:

If the pairing test above does not resolve the problem, then the modules may be too far from each other for an effective RF link. To test this, simply connect the Home Transmitter outside, close to the hot tub (via an extension cord for power).

A router connection is not needed for this test. If the module LEDs no longer blink, an RF link was established which confirms the hypothesis that the modules were too far apart. Getting the modules closer together somehow is the only solution.

If moving the modules closer together does not stop the LEDs from blinking, attempt to pair them again. If this pairing fails even though the RF modules are near each other, then one or both of the modules are defective, replace them.

MAINTENANCE

FILTER CARTRIDGE REMOVAL AND CLEANING

Cleaning mechanical contaminations via continuous water circulation and chemical mixture is a basic requirement for proper cleaning of the hot tub water. Every hot tub has an engine designed for this purpose. The circulation engine circulates the water through the filter(s). The filter protects against contamination floating in the water.

Cleaning of the filter cartridges is recommended weekly.

Soaking the filter cartridges in water mixed with chlorine or antialgae agents for 24 hours is recommended monthly.

Changing the filter cartridges is necessary every 3 months.

SURFACE MAINTENANCE

Wipe the surface with a wet cloth. Always use a neutral cleaning product and a soft wiping cloth. Never scratch the acrylic surface with an abrasive tool, blade, or knife, because it may cause damage. Never use nail polish remover, acetone, or paint stripper when cleaning the surface because it may cause damage.

Maintenance manual for the control panel of the hot tub:

- Do not damage the control panel with anything hard. If possible,
- Avoid exposing the control panel to direct sunlight.
- When not using the hot tub, always use a hot tub cover.

WINTERIZATION

Remember to correctly maintain the hot tub if you are not using it in the winter. If you are not using your hot tub during the winter months and want to put it out of service properly, call one of our qualified professionals to winterize your hot tub at a prearranged date and time.

The winterization encompasses the following:

- Drainage of used water
- Cleaning of the inner surface of the hot tub
- Dewatering of pipe and jet system
- Dewatering and disconnecting the engine's interface
- Delivery - reception

If the hot tub is not winterized properly, the system can retain water that can easily freeze during the winter months. This can cause heavy irreparable damage to the pipes and the engine. This will void the warranty.

Maintenance of the out-of-service hot tub:

When you are not using the hot tub, use the thermo cover and fasten it with the buckles. Do not forget! If the hot tub is filled with water and you are not using it, lift the cover at least once a week to ensure proper ventilation. The thermo cover is multipurpose. Most importantly it decreases the heating time of the water to operational temperature and decreases the energy needed to maintain water temperature, decreasing the operational costs.

Using the cover you can avoid leaves, rain, snow, or other contamination entering the hot tub water, effectively sealing it off from environmental effects.

Fastening the cover with buckles prevents young children from using it without parental supervision.

CLEAN THE FILTER CARTRIDGES WEEKLY AS FOLLOWS:

WARNING!

Changing the filter cartridges is recommended every 3 months!

Operating the hot tub without a filter cartridge is PROHIBITED

1. Remove the lid of the filter.
2. Take out the filter cartridge.
3. Clean contamination from the cartridge with water.
4. Soak the cartridge in lukewarm water mixed with chlorine or antialgae agents for 1-2 hours, then rinse it.

Never use an alkaline detergent or a high-pressure cleaner to clean the filter!



DRAINING THE WATER

You can drain the water via the drain outlet in accordance with environmental standards.

1. You'll need a hose a wet and dry vacuum cleaner and a bottle of wellis crystal spa cleaner fluid.
2. Pour the cleaner fluid into the water one day before draining and run the open jets at maximum performance for 20 to 25 minutes. The cleaner will remove any lime scale and dirt from the spa and its pipe work.
3. Before draining the spa remove the filters, this is a good time for cleaning or replacing them.
4. You don't need a pump for draining the water pull out the draining valve to the limit.
5. Remove the cap and attach the hose.
6. Push back the valve halfway then rotate and secure it in this position, this will start the flow of water. We recommend rinsing the tub while it drains
7. When the tub is empty remove the hose and close the valve.
8. Use a wet and dry vacuum to clean up any remaining water from the spa and the jet nozzles.

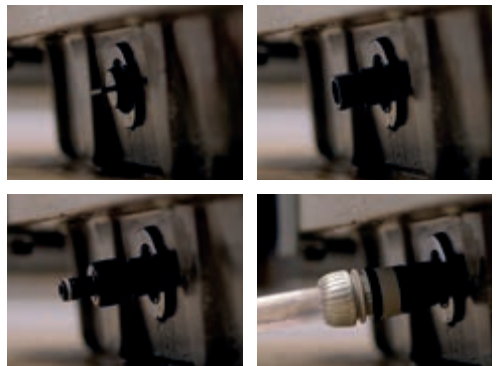

WIRING DIAGRAM - W2000

W2000



WIRING DIAGRAM - W2000

ELECTRICAL WIRING

ELECTRICAL WIRING: ALL MODELS

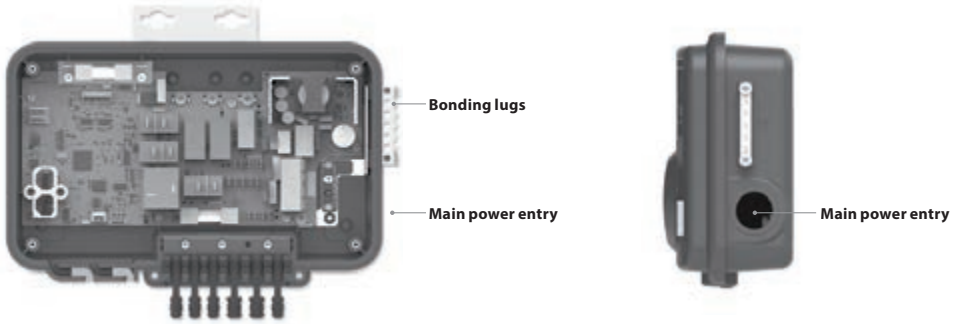

WARNING!

Disconnect power before starting electrical work. Wiring must be completed by a qualified electrician and must be done in accordance with the local electrical code.

Do not use a wire gauge bigger than 8 AWG.

To complete the electrical connections of the in.yj control system you will need a Phillips screwdriver and a flat-head screwdriver.

Remove the screws from the system control lid and remove it.

Remove 5 1/2" (142 mm) of cable insulation.

Strip away 1/2" (15 mm) of insulation from each wire.

Pull the cable through the cutout of the box and secure it with a 3/4" NPT strain relief* (hole diameter 1.09" [27.6 mm]). Ensure that the NPT strain relief clamps around the outer sheath of the cable.

*** For CE/AUS/NZ use an IEC certified plastic bushing that will maintain the IPX5 rating.**



WARNING!

For units for use in other than single-family dwellings, a clearly labeled emergency switch shall be provided as part of the installation. The switch shall be readily accessible to the occupants and shall be installed at least 5' (1.52 m) away, adjacent to, and within sight of the unit.

This product must always be connected to a circuit protected by a ground fault interrupter.

Proper wiring of the electrical service box, GFCI and in.yj terminal block is essential!

Check your electrical code for local regulations. Only copper wire should be used, never aluminum.

Disposal of the product



The appliance (or the product) must be disposed of separately in accordance with the local waste disposal legislation in force.



Main electrical box

GFCI panel

WIRING DIAGRAM - W2000

ELECTRICAL WIRING

ELECTRICAL WIRING: NORTH AMERICAN MODEL

Refer to wiring diagram in the enclosure box lid for more information.

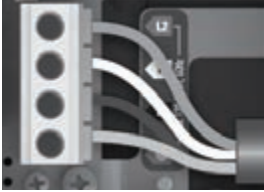

120 V (3 WIRES)

DO NOT REMOVE THE BROWN WIRE. Insert each wire into the appropriate socket of the main entry terminal block according to the color code indicated on the sticker. Use a flat screwdriver to tighten the screws on the terminal.

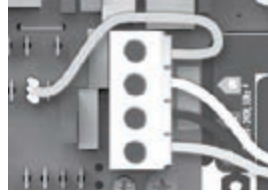

240 V (4 WIRES)

Remove the brown wire and insert each wire into the appropriate socket of the main entry terminal block according to the color code indicated on the sticker. Use a flat screwdriver to tighten the screws on the terminal.

After making sure wires are securely connected, push them back into the box and replace the cover. Do not over tighten cover screws (torque to 8 in.lb max {0.9 N.m.}). Connect the bonding conductor to the bonding lug on the side of the hot tub pack (a grounded electrode conductor should be used to connect the equipment grounding conductors).

WIRING DIAGRAM - W3000 & W5000

W3000 & W5000



WIRING DIAGRAM - W3000 & W5000

CONNECTIONS

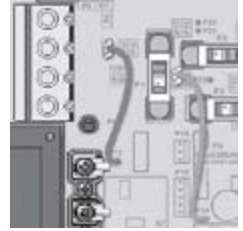
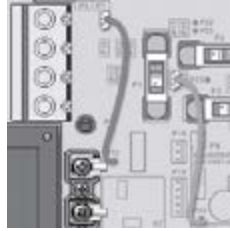

Connections for 120 V heaters (1 kW)

BROWN wire must be correctly connected between P12 and P10.

For early North American version installations the YELLOW wire must be between P25 and P20. The ORANGE wire must be between P24 and P16.

Connections for 240 V heaters (North American installations only).

BROWN wire must be correctly connected between P12 and P9.

Note: To convert model to a 120 V system, the white (common) accessory wire must be moved. See wiring diagram for details.

WIRING DIAGRAM - W8000

CONNECTIONS

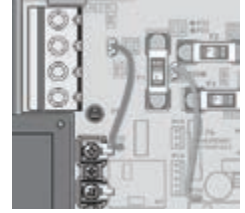
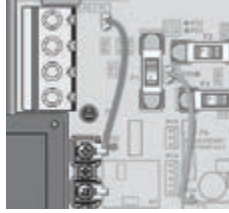
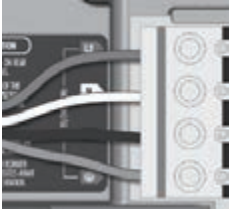

Connections for 240 V heaters (North American installations only)

BROWN wire must be correctly connected between P12 and P9.

For early North American version installations the YELLOW wire must be between P25 and P20, the ORANGE wire must be between P24 and P16.

Connections for 120 V heaters (1 kW)

BROWN wire must be correctly connected between P12 and P10.

Note: To convert model to a 120 V system, the white (common) accessory wire must be moved. See wiring diagram for details.

BREAKER SETTING

POWER UP AND BREAKER SETTING

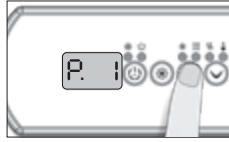

It is important to specify the current rating of the GFCI/RCD used to ensure a safe and efficient current management (and reduce nuisance GFCI/RCD trippings).

Press and hold the Prog. button until you access the breaker setting menu. (the programming menu will appear first). If your control system is equipped with the phase configuration menu, it will appear before the breaker setting menu.

Note: if the keypad does not have the Prog. Key, use the Light key.

For color display keypad go in setting menu.

The tables below indicate the typical value of b for different GFCI/RCD ratings.

Choose the one that corresponds to your breaker.

Note: Every OEM has its own pre-established configurations.

Choose the number of phases supplying your hot tub (1 to 3). Use the **Up** or **Down** keys to select the number of phases and press on the **Prog.** key to confirm your selection.

The values displayed by the system correspond to 80% of the maximum amperage capacity of the GFCI.

Use the Up or Down keys to choose the desired value.

The value can typically be modified from 10 to 48 A.

Press on the Prog. key to set the breaker rating.



W3000, W5000

GFCI/RCD	b
60A	48A
50A	40A
40A	32A
30A	24A
20A	16A

* Only available on in.yj-3.

BREAKER SETTING

POWER UP AND BREAKER SETTING

IMPORTANT Please read the following before starting the device.

Verify that all accessories are linked to the ground lug and connected to the to the control system.

A minimum flow of 68 LPM (18 GPM) is required. Make sure that all valves are open in the hot tub plumbing and that the water flow is sufficient between the main pump and the water heater.

Turn on the breaker.

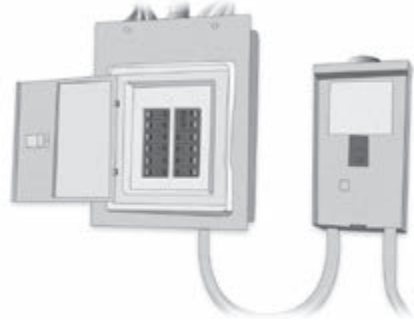

IN.FLO DRY-FIRE PROTECTION

At start up, the in.flo's detector verifies the water flow according to the following sequence:

The Pump 1 or the circulation pump runs for a period of 2 to 5 minutes.

The display will show "--" during the flow verification. After this time, the system confirms if flow is adequate or not.

If the flow is sufficient, the temperature of the water is displayed on the keypad screen. When the water has reached the consigned temperature plus 0.45°C (0.8°F), the water heater turns off.

DISPLAY SEQUENCE AT START UP (EVERY PARAMETER IS DISPLAYED FOR 2 SECONDS)



Lamp test

All segments and LEDs light up.



Software number

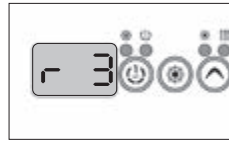

Software revision

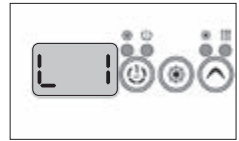

Low-level selected

Low-level selected from the low-level menu.

FREQUENTLY ASKED QUESTIONS

QUESTIONS CONCERNING CLEANING, WATER TREATMENT, AND MAINTENANCE

What should I do if the filter of the hot tub is polluted?

Clean the filter every week or two weeks with a jet of water. Periodically, depending on usage, soak the filter in water mixed with an anti-algae agent for 1-2 hours, then rinse it.

Should I shower before using the hot tub?

Yes, thoroughly.

Should the side cover of the hot tub be treated?

The side cover is made from weather resistant plastic. It does not require treatment or maintenance (except if it is a cedar cover).

How often should the water be changed if my hot tub has the in.clear water maintenance system? Does it maintain water quality?

With the cutting-edge automated brominating in.clear system water only has to be changed approximately once every 6 months. This can be even longer if the hot tub is not used daily. Adding water and Trublū (sodium bromide) may be necessary if the water level decreases because of splashing or evaporation. Optional UV-C antibacterial agents, disinfectant, and a sterilization system are available for our hot tubs. These guarantee fresh and pure water using 30-50% fewer chemicals.

What kind of water treatment do you recommend in case of communal use?

In case of communal use we recommend the optional sand filtration device that comes in place of the standard antibacterial filter. In case of heavy usage we recommend the automated monitoring-, regulating-, and chemical dispenser device.

I cannot stop the heavy foaming. Before using the hot tub we shower without using soap and I use the necessary chemicals. Did I use too little?

As described in the user guide of the products, apply 1-2 cups of antifoaming agent to the hot tub water. Wait for the chemical to thoroughly mix with the water. Repeat if necessary. If the problem is still present, check and readjust the pH value. If foaming still occurs, disinfect the hot tub with an anti-algae chemical containing free active chlorine, then drain, clean, rinse, and refill the hot tub.

PREPARATION OF THE INSTALLATION SITE

What are the most important concerns when selecting the installation site?

The installation site should be prepared in accordance with the installation guide by a professional. The devices can only be installed and set up at appropriate installation sites. Make sure there is an appropriate cable length, electric supply, a 30mA protective relay, and with certain products a floor drain.

Is a floor drain necessary for an indoor hot tub?

Building a floor drain is mandatory!

TECHNICAL DATE OF THE PRODUCT, USAGE

What type of water circulation engine is used for massage hot tubs?

Our massage hot tubs are equipped with Laing low power (110W) energy saving, silent circulating motor pumps.

What is the maximal temperature that does not damage the hot tub?

The water temperature can be adjusted to between 26 and 40 degrees Celsius.

What is the recommended optimal water temperature?

32-38 degrees Celsius. If young children are using the hot tub, lower temperature is recommended. Always check the water temperature before the child steps into the hot tub and make sure that the temperature is suitable for the child.

Can the system freeze? Is there a sensor that starts emergency heating in case of freezing?

In the winter the unused hot tub should be winterized. After draining the hot tub we will defrost the system as necessary, meaning that we will remove the water retained by the engine and the pipes. For details and pricing please call our customer service. If the hot tub remains in use during the winter, the engines start if there is a danger of freezing and heat the water to 8°C

Can the system be programmed to start heating at certain time?

There is no way of setting a time and date for automatic heating. Because of concerns of energy efficiency heating the water to greater temperatures is not recommended in case of multiple weekly usage.

The jet of the hot tub shuts down automatically after 15 minutes of operation. Can I restart it immediately, or do I have to wait? Can I restart it as many times as I want without a break? How does this affect the jets?

The hydromassage system shuts down every 15 minutes for security reasons - to avoid possible muscle soreness. It can be restarted for any amount of times and without a break.

Is this the same for the bubble massage function?

Yes, it is the same for the bubble massage function.

FREQUENTLY ASKED QUESTIONS

When do we not use the hot tub often, mostly in the winter (around 3 times a week), which is the most energy efficient setting, taking into account the energy necessary for reheating? We only use it a couple of times a week, 37 degrees Celsius is our favourite temperature. Should it be in Sleep or Economy mode? Should I switch to the Standard setting only when heating the hot tub? Or should it always stay on Standard?

If you only use it 2-3 times a week, the most efficient way is to keep the water at operational temperature (38 degrees Celsius). Thanks to the excellent insulation and the thermo cover this setting requires less energy than letting the water cool down and reheating it before usage. The heating system automatically switches on in case the water temperature drops more than half a degree Celsius. In the summer the Economy setting is recommended as the external temperature is usually high. Only use the Sleep setting if you are not using the hot tub for a longer period of time (3-4 weeks).

Does the hot tub switch back to the last used setting if there is a power outage?

When connecting the hot tub to the power supply it switches to charging mode. Push the "Temp" button to set it to the Standard setting and it will display the water temperature. The hot tub will switch back to the last used setting after a power outage.

Can the filtration cycle only be programmed to 1-8 hour periods? Is there something like a 3-hour period? What is ideal and what is adequate?

The filtration cycle can be set to 1-8 hour or continuous settings. If you have a hot tub equipped with the in.clear automatic water management system, a daily 8-hour circulation period is recommended to produce necessary amounts of bromine. The 8-hour (2x4 hour) setting is ideal.

Can the operating device for our hot tub be placed in an external location where only the staff can access it?

The operating device can only be placed 5 meters cable length away from the hot tub.

What is the service life of the UV-C lamp?

If the filtration cycle is set to the continuous (0-24) setting, then the service life of the UV-C lamp is 8000-9000 hours. With continuous setting the most effective water disinfectant system can reduce the necessary amount of chemicals by 30-50% depending on usage.

IN.CLEAR

Why is the water turbulent/oily?

If the water is turbulent or oily after heavy usage, perform a refill and wait 24 hours until conditions are suitable for usage. If the problem persists, contact your service provider to perform the necessary water equilibration.

Does sodium-bromide vaporize?

No. Sodium-bromide will only leave the hot tub in case of splashing, leaking, or draining.

What should I use to clean my hot tub?

Only nonfoaming nonacetic cleaning products available at professional dealerships.

If the in.clear bromine generator is switched off, is the hot tub still being disinfected by sodium bromide?

No. The in.clear system does not disinfect while switched off. However, if there is a level of bromine left over in the water, it will continue the disinfecting process. The In.clear system can be switched off for certain periods of time and the hot tub will remain nice and clean. Sodium bromide becomes bromine when it passes through the electrodes of the in.clear system, while the pump connected to the in.clear system is operational.

The products included in the user manual are for illustration purposes only, and may not always match the specifications of the advertised product. Manufacturer reserves the right to modify the products – including the product range – without prior notice since they are valid at the time they are delivered to the printing press. We may not be made responsible for printing errors.

